



# 2026 CATALOG SUPPLEMENT

Class		Page No
08	<b>TIRES &amp; TUBES</b>	Sup. 2
09	<b>BEARINGS &amp; BUSHINGS</b> Ball Bearing, Spindle & Deck Bearings	Sup. 3-4
10	<b>DECK &amp; WHEEL PARTS</b> Caster Yokes, Deck Springs, Steering Components, Spindle Assemblies & Electric Clutches	Sup. 4-7
12	<b>BELTS</b> O.E.M. Replacement	Sup. 8
13	<b>PULLEYS</b> Idlers & Spindle Pulley	Sup. 8-9
15	<b>O.E.M. REPLACEMENT BLADES</b>	Sup. 9-11
16	<b>EDGER BLADES</b>	Sup. 11
19	<b>AIR &amp; OIL FILTERS</b>	Sup. 11
20	<b>FUEL LINE &amp; ACCESSORIES</b> Fuel Clamps, Fittings, etc.	Sup. 12
21	<b>SEATS</b> Seats	Sup. 12
22	<b>SMALL ENGINE CARBURETION</b> Diaphragms, Carburetors & Fuel Modules	Sup. 12-14
24	<b>SPARK PLUGS &amp; ACCESSORIES</b> Spark Plugs	Sup. 14
28	<b>GRASS CATCHERS</b>	Sup. 14
31	<b>IGNITION</b> Ignition Coils, Stators & Voltage Regulators	Sup. 15
32/33	<b>TOOLS, LAWN AND GARDEN ACCESSORIES</b>	Sup. 15-18
34	<b>CHAIN SAW CHAIN</b>	Sup. 18
36	<b>CHAIN SAW SPROCKETS</b>	Sup. 19
38	<b>CHAIN SAW CARBURETION</b>	Sup. 19-20
43	<b>ARBORIST</b> Rope, Rope Assemblies, Hardware, Gear, Bags & Tree Trimmers	Sup. 21-37
	<b>INDEX</b>	Sup. 38-40

**NEW**

**15 X 6.00 X 6 Tire From CARLISLE**



**Order No. 08 - 8920**

Carlisle Tubeless Tire. 15 x 600 x 6. Turf Saver II / 2 Ply.

**16 X 7.50 X 8 Tire From KENDA**



**Order No. 08 - 17517**

Kenda 16 x 7.50 - 8, 16 x 750 x 8, 4 ply Tire. Replaces Kenda Super Turf K500 10500086181. 4 ply Tubeless.

**18 X 8.50 X 8 Tire From KENDA**



**Order No. 08 - 17490**

Kenda 18 x 8.50 - 8, K3012, 4 Ply Tubeless Tire. Replaces Kenda 1030121808B1.

**23 X 1050 X 12 Tire From KENDA**



**Order No. 08 - 17491**

Kenda 23 x 1050 x 12 K3012, 4 Ply Tubeless Tire. Replaces Kenda 251W1060.

Order No.	Tread / Description
<b>Turf Tread - 4-Ply - GALAXY MIGHTY MOW</b>	
<b>08 - 17607</b>	Galaxy Mighty Mow 16 x 6.50 - 8 tubeless tire
<b>08 - 17606</b>	Galaxy Mighty Mow 16 x 7.50 - 8 tubeless tire
<b>08 - 17605</b>	Galaxy Mighty Mow 18 x 8.50 - 8 tubeless tire
<b>08 - 17604</b>	Galaxy Mighty Mow 20 x 10.00 - 8 tubeless tire
<b>08 - 17603</b>	Galaxy Mighty Mow 23 x 9.50 x 12 tubeless tire
<b>08 - 17601</b>	Galaxy Mighty Mow 24 x 12.00 - 12 tubeless tire
<b>Turf Tread - 6-Ply - GALAXY MIGHTY MOW</b>	
<b>08 - 17602</b>	Galaxy Mighty Mow 24 x 9.50 x 12 tubeless tire



The Galaxy Mighty Mow tubeless tire is a specifically designed mower tire with a unique tread pattern for turf with maximum turf protection. Highly durable and long lasting. Delivered as manufactured (Non Compressed).

**Tubes**

Order No.	Size	Valve Type
<b>5" Tubes</b>		
<b>08 - 17518</b>	Tube 11 X 6.00 X 5	Straight Stem
<b>08 - 17519</b>	Tube 11 X 6.00 X 5	L Stem



**Spindle Bearing for BLUE BIRD**

ID 1.84" (46.73mm)  
OD .84" (21.33mm)  
Height 3/4" (19.05mm)

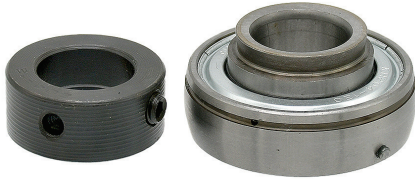
**Order No. 09 - 17672**

Shaft Bearing with Locking Collar & Set Screw replaces Bluebird 0315. Fits models F20 & F20B. Compare to Rotary No. 09-8863.

**Spindle Bearing for EXMARK**

ID .984" (24.99mm)  
OD 2-7/16" (61.91mm)  
Height 21/32" (16.67mm)

**Order No. 09 - 17665**

Spindle Bearing replaces Exmark 1-303543, 1-303057, Bobcat 35008N, Buton PL4611, PL4609, Snapper/Kees 19125, 76510, John Deere 9467, also fits Scag. Compare to Rotary No. 09-3217.

**Upper Spindle Bearing for HUSQVARNA**

ID .669" (17mm)  
OD 1.57" (40mm)  
Height .472" (12mm)

**Order No. 09 - 17668**

Upper Spindle Bearing replaces Husqvarna 532110485. Fits Husqvarna homeowner mowers with three and four bolt spindles. Compare to Rotary No. 09-8507.

**Caster Wheel Bearing for HUSTLER**

ID 3/4" (19.05mm)  
OD 1-3/4" (44.45mm)  
Height 1/2" (12.70mm)

**Order No. 09 - 17660**

Caster Wheel Bearing replaces Hustler 039677. Also replaces MTD 941-3032. Fits Hustler Z, Super Z, X-One, and Super 104. Compare to Rotary No. 09-11835.

**Deck Pulley Bearing for MTD**

ID 5/8" (15.87mm)  
OD 1-3/8" (34.92mm)  
Height 0.437" (11.09mm)

**Order No. 09 - 17670**

Stack Pulley Bearing replaces MTD 941-0524A. For older MTD and Cub Cadet mower decks. Fits 42", 48", 50", and 54" decks with primary and secondary deck drive belts. Bearing is sealed on both sides. Compare to Rotary No. 09-483.

**Spindle Bearing for SCAG**

ID .984" (24.99mm)  
OD 2.43" (61.89mm)  
Height .656" (16.66mm)

**Order No. 09 - 17671**

Deck Spindle Bearing replaces Scag 48101. Fits Scag walk-behind mowers. Compare to Rotary No. 09-7178.

**Snap Ring Ball Bearing for SNAPPER**

ID 5/8" (15.87mm)  
OD 1-3/8" (34.92mm)  
Height 0.437" (11.09mm)

**Order No. 09 - 17669**

High Speed Snap Ring Bearing, Double sealed, replaces Snapper 1-0756 (Chain Case Ball Bearing). May be used with or without retaining clip. Compare to Rotary No. 09-481.

**Spindle Bearing for TORO**

ID .984" (25mm)  
OD 2.04" (52mm)  
Height .591" (15mm)

**Order No. 09 - 17666**

Spindle Bearing, sealed one side, replaces Toro 113514. Fits Wheel Horse 50" & 60" cut ZTR 500 series mowers. Fits Grasshopper 33210. Also fits Snapper 19572, 79813, ZTR 42", 48" & 60" decks. Compare to Rotary No. 09-7162.

**NEW**

**Spindle Bearing for TORO (cont.)**

ID .669" (17mm)  
OD 1.57" (40mm)  
Height .472" (12mm)



**Order No. 09 - 17667**



Spindle Bearing, sealed one side, replaces Toro 109966. Fits 42" and 48" decks. Compare to Rotary **09-7210**.







**Caster Yoke for HUSTLER**



**Order No. 10 - 17135**



Caster Yoke replaces Hustler 110116. Fits Raptor 36", 42", 52", Surfer Pro 34", 48", Dash XD 34", 42" 48" and some Hustler Sports. Width inside forks 4.75" (120.65mm), Pivot Diameter 1" (25.40mm) and Axle Diameter 0.5" (12.70mm).

Order No.	Description	Length Overall	Length of Coil	Coil Dia.	Thick-ness
<b>Springs for BAD BOY</b>					
 <b>10 - 17549</b>	<b>Deck Idler Spring</b> , replaces Bad Boy 034-2020-00. Fits all Bad Boy models	6-3/4"	4-1/2"	1-1/8"	3/16"
		171.45mm	114.30mm	28.57mm	4.76 mm
<b>Springs for WRIGHT</b>					
 <b>10 - 17654</b>	<b>Operator Presence Spring</b> , replaces Wright 16410014. Fits models WS4817KAWRE, WS4818KAWRE, WS4819KAWRE, WS4820KAWRE, WS4824KAWRE, WS48FFX730E, WS5224KAWRE, WS6125KAWRE, WS61FFX730E, and many others.	2"	1.10"	0.56"	0.0760"
		50.80mm	27.94mm	14.22mm	1.93mm
 <b>10 - 17655</b>	<b>Pump Lock Spring</b> , replaces Wright 16410008. Fits models WS3215KAW, WS3215KOH, WS3218KAWRE, WS32FS541, WS36125KAW, WS3615KAW, WS3616KAW and many others.	2.55"	1.60"	0.6270"	0.0760"
		64.77mm	40.64mm	15.92mm	1.93mm
 <b>10 - 17658</b>	<b>Chute Deflector Spring</b> , replaces Wright 16460002. Fits 32" and 36" models.	3.10"	3.10"	0.875"	0.120"
		78.74mm	78.74mm	22.22mm	3.04mm
 <b>10 - 17653</b>	<b>Hydro Belt Idler Spring</b> , replaces Wright 16420002. Fits models WS3217KAW, WS3615KAW, WS3617KAW, WS4215KAW, WS4217KAW, WS4817KAW, WS4819KAW and many others.	3-1/2"	2.06"	1"	0.105"
		88.90mm	52.32mm	25.40mm	2.66mm
 <b>10 - 17657</b>	<b>Brake Axle Spring</b> , replaces Wright 16410022. Fits models WZXT52S61G8E1B, WZXT61S61G8E1B and WZXT72S-61G8E1B.	5-1/2"	4"	1"	0.148"
		139.70mm	101.60mm	25.40mm	3.75mm

Order No.	Description	Length Overall	Length of Coil	Coil Dia.	Thick-ness
<b>Springs for WRIGHT (cont.)</b>					
 <b>10 - 17656</b>	<b>Deck Lift Spring</b> , replaces Wright 16460008. Fits models WSES3617KAWE, WSES3618KAWRE, WSES3619KAWE, WSES3620KAWE, WS4217KAWE, WSES4819KAWE, WSES5219KAWE and many others.	9"	6.15"	1.69"	0.218"
		228.60mm	156.21mm	42.92mm	5.53mm

**Spindle Assembly for CUB CADET**

**Order No. 10 - 17612**

Spindle Assembly replaces Cub Cadet/MTD 918-06979 and 618-06979.

**Order No. 10 - 17613**

Spindle Assembly replaces Cub Cadet/MTD 918-06981 and 618-06981.

**Order No. 10 - 17614**

Spindle Assembly replaces Cub Cadet/MTD 918-06076A and 618-06076A.

**Order No. 10 - 17615**

Spindle Assembly replaces Cub Cadet/MTD 918-06993A and 618-06993A.

**Spindle Assembly for HUSTLER**

**Order No. 10 - 17616**

Spindle Assembly replaces Hustler 607418. New version, bolts included.

**Spindle Assembly Kit for JOHN DEERE**

**Order No. 10 - 17622**

Spindle Assembly replaces John Deere AM126225. Fits LT160 and LT180 models.

**NEW**

**Wheel Spindle Kit for JOHN DEERE**



**Order No. 10 - 17620**



Wheel Spindle Kit replaces John Deere GY22251 (right side). Fits D120, D140, S240, and X125 models.

**Wheel Spindle Kit for JOHN DEERE**



**Order No. 10 - 17621**



Wheel Spindle Kit replaces John Deere GY22252 (left side). Fits D120, D140, S240, and X125 models.

**Electric Clutch for ARIENS**



**Order No. 10 - 17674**



Electric Clutch replaces Ariens 03643100. Fits Ariens, Husqvarna, Cub Cadet, John Deere, Snapper and others. Refer to your owners manual for O.E. part number. ID 1" (25.4mm), Pulley Dia. 5.34" (135.63mm).

**Electric PTO Clutch for ARIENS**



**Order No. 10 - 17684**



Electric PTO Clutch replaces Ariens 03785000. Also fits Scag 462166 and Ferris 5023232, 5023232SM. Fits walkbehind units. Ogura No. GT2.5FE-02. ID 1" (25.4mm), Pulley Dia. 6" (152.4mm), Height 3" (76.2mm).

**Electric Clutch for CASTLEGARDEN**



**Order No. 10 - 17678**



Electric Clutch replaces Castlegarden 118399063. Fits GGP 98cm side discharge. Replaces Alpina, Stiga, Efco, Sabo, and Dolmar. Warner 5217-45 and 5217-89. 1" (25.4mm), Pulley Dia. 5.21" (132.33mm).

**Electric PTO Clutch for CUB CADET**

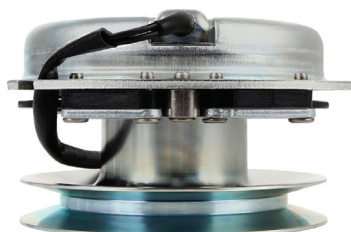

**Order No. 10 - 17676**



Electric PTO Clutch replaces MTD/Cub Cadet 917-05209. Fits many MTD/Cub Cadet models. Consult your parts manual for applicable models. ID 1" (25.4mm), Pulley Dia. 6" (152.4mm).

**Electric Clutch for EXMARK**



**Order No. 10 - 17677**



Electric Clutch replaces Exmark 116-1620. Uses 5/8" belt, 200 Ft-lb, 1.125" bore. Fits Exmark Vantage. ID 1.125" (28.57mm), Pulley Dia. 7.4" (187.96mm), Height 3.75" (95.25mm).

**Electric PTO Clutch for EXMARK**

**Order No. 10 - 17680**

Electric PTO Clutch replaces Exmark 126-2601 and Warner 5218-348. ID 1.125" (28.57mm), Pulley Dia. 7.34" (186.43mm).

**Electric Clutch for EXMARK**

**Order No. 10 - 17682**

Electric Clutch replaces Exmark 103-3246. Fits 27 & 30 HP Kohler Lazer Z. Warner 5218-99 and 5218-202. ID 1.125" (28.57mm), Pulley Dia. 7.34" (186.43mm)

**Electric Clutch for GRAVELY**

**Order No. 10 - 17685**

Electric Clutch replaces Gravely 04553800, Dixie Chopper 500144, Ferris 5100417, Husqvarna 532179335, and Kubota k3011-10050. Fits Gravely Pro Turn 48", 52", and 60" mowers. ID 1.125" (28.57mm), Pulley Dia. 6" (152.4mm), Height 3.56" (90.42mm)

**Electric PTO Clutch for HUSTLER**

**Order No. 10 - 17679**

Electric PTO Clutch replaces Hustler 605827K. Fits Raptor 36", 42" and 52". Warner 5219-193 clutch only. ID 1.125" (28.57mm), Pulley Dia. 5.7" (144.78mm).

**Electric PTO Clutch for HUSTLER**

**Order No. 10 - 17683**

Electric PTO Clutch only replaces Hustler 604244K. Fits Raptor and Raptor Limited with Kawasaki engine. Uses 1/2" or 5/8" belt. Replaces Warner 5217-76. ID 1" (25.4mm), Pulley Dia. 5.35" (135.89mm), Height 3" (76.2mm).

**Electric Clutch for JOHN DEERE**

**Order No. 10 - 17673**

Electric Clutch replaces John Deere AM121972. Fits John Deere STX38 & 46 serial number 270001 and up and all export 12.5 & 14 HP. Replaces Warner 5217-36. ID 1" (25.4mm), Pulley Dia. 5.25" (133.35mm), Height 3.5" (88.9mm)

**Electric PTO Clutch for MTD**

**Order No. 10 - 17681**

Electric PTO Clutch replaces MTD 917-05121, 717-05121. Fits models Z6000, ZT42 AND ZT-L42. Replaces Warner 5217-77 and 5217-90. ID 1" (25.4mm), Pulley Dia. 5.923" (150.44mm).

**Electric PTO Clutch for WRIGHT**

**Order No. 10 - 17675**

Electric PTO Clutch replaces Wright 71410014 Fits Wright Standard and Sentar Sport Models. For 5/8" belt. Replaces Warner 5219-54. ID 1" (25.4mm), Pulley Dia. 7.125" (180.97 mm), Height 3" (76.2mm).

**Belts**



Order No.	Replaces OEM No.	Size	Description / Replaces
<b>ARIENS</b>			
<b>12 - 17510</b>	07200802	38-5/16" x 1/2" (972.98 mm x 12.70 mm)	<b>Snow Thrower Auger Belt Set.</b> Fits the Deluxe 24" and Deluxe 28" machines. Raw edge.
<b>GRAVELY</b>			
<b>12 - 17508</b>	07200510	135-1/2" x 5/8" (3441.70 mm x 15.87 mm)	<b>Deck Drive Belt.</b> Fits ProMaster and ProTurn Models. Replaces belt size 135.5" x 5/8" Hex.
<b>12 - 17509</b>	0722640	69-9/36" x 1/2" (1758.95 mm x 12.70 mm)	<b>Pump Drive Belt.</b> Fits 48", 52", and 60" ProTurn and ProStance. Cogged.
<b>HUSQVARNA</b>			
<b>12 - 17458</b>	574285901 588264802 575658401 900078	5/8" x 169-3/4" (15.87 mm x 4311.65 mm)	<b>Deck Belt.</b> Wrapped 5V, 169.67" EL Aramid Cord. Fits models PZ29 and PZT54 with 54" deck.
<b>SCAG</b>			
<b>12 - 17457</b>	483520	1/2" x 52" (12.70 mm x 1320.80 mm)	<b>Pump Drive Belt.</b> Raw Edge Cogged 52" belt and fits the Scag V-Ride and Pro V mowers.
<b>SNAPPER</b>			
<b>12 - 11677</b>	7046784	3/8" x 24-1/2" (9.52 mm x 622.30 mm)	<b>Drive Belt.</b> Fits 21" Steel deck series self propelled mowers.
<b>TORO</b>			
<b>12 - 17459</b>	115-7407	5/8" x 174-3/4" (15.87 mm x 4438.65 mm)	<b>Deck Belt.</b> Wrapped 5V, 174.75" EL Aramid Cord. Fits the Toro Z Master Models 74901, 74902 and 79252 with 48" Decks.
<b>12 - 17511</b>	125-9371	159" x 5/8" (4038.60 mm x 15.87 mm)	<b>Deck Drive Belt.</b> Fits the Toro Z Master Pro 5000 and 6000 series 60" rear discharge mowers. *Aramid cord construction.
<b>12 - 17512</b>	116-8187	93" x 5/8" (2362.20 mm x 15.87 mm)	<b>Secondary Deck Drive Belt.</b> Fits on Toro Z Master Pro 5000 and 6000 series 60" rear discharge mowers. Double B wrapped belt with *Aramid cord construction.
<b>WALKER</b>			
<b>12 - 8819</b>	7234	3/8" x 28" (9.52 mm x 711.20 mm)	<b>Blower Belt.</b> Fits Walker Model T Blower. Cogged Belt, Polyester Cord Construction.

\* Made with KEVLAR® or non-trade marked Aramid fiber. • "Belts are manufactured to meet OEM specifications"

**V-Idler Pulley**

ID .669" (17mm)  
OD 5" (127mm)  
Width .870" (22.09mm)



**Order No. 13 - 10158**

Composite V-Idler Pulley. 0.64" X 5" Composite VIP5000-5.403.

**V-Idler Pulley**

ID .669" (17mm)  
OD 6" (152.4mm)  
Width 1-5/32" (29.37mm)



**Order No. 13 - 10159**

Composite V-Idler Pulley. 0.93" X 6" Composite VIP6000-6.403.

**Idler Pulley For HUSQVARNA**

ID 3/8" (9.52mm)  
OD 4-1/2" (114.30mm)  
Height 1-1/2" (38.10mm)

**Order No. 13 - 17619**

Idler Pulley replaces Husqvarna 175080, 189993, and 532193195.

**Spindle Pulley For MTD**

12 Point Spline  
OD 5-13/64" (132.15mm)  
Height 1" (25.4mm)

**Order No. 13 - 17617**

Spindle Pulley replaces MTD/Cub Cadet 756-05036. Fits Cub Cadet RZT-S50 and RZT-SX models.







**Spindle Pulley For MTD**





ID 3/4" (19.05mm)  
OD 5-39/64" (142.47mm)  
Height 3/4" (19.05mm)

**Order No. 13 - 17618**

Spindle Pulley replaces MTD/Cub Cadet 756-04459A, 756-04459, and 756-3106. Fits Cub Cadet LT1018, and GTX2154 models.

ORDER NO.	Replaces O.E.M No.	Length	Center Hole Diam.	Outside Hole Diam.	Center to Center	Width	Steel Thick	Application
<b>Blades for BAD BOY</b>								
<b>15 - 16047-6</b> 	038-0001-00	<b>18-3/4"</b> 476.25mm	<b>5/8"</b> 15.9mm			<b>2-1/2"</b> 63.5mm	<b>.250"</b> 6.3mm	<b>Heavy Duty Boxed Blade.</b> (6) of our <b>15-16047</b> Blades. Requires 3 blades for 54" Cut. Fits 54" Out-law, 54" ZT, 54" CZT, and 54" Stand-On. Ideal for Commercial Cutters. Heavy Duty version of our <b>15-15112</b> .
<b>Blades for DAYE / HYPER TOUGH</b>								
<b>15 - 17507</b> 	84005221	<b>21"</b> 533.4mm	Oval			<b>2-1/4"</b> 57.2mm	<b>.125"</b> 3.2mm	21" Hyper Tough as well as 2105200317 and 2105200317A.
<b>Blades for EGO</b>								
<b>15 - 17500</b> 	AB5201D	<b>18"</b> 457.20mm	<b>33/50"</b> 16.6mm			<b>2"</b> 50.8mm	<b>.158"</b> 4.0mm	High Lift Blade. Fits EGO Power+ 52" Z6 Zero Turn Riding Mower ZT5207L.
<b>15 - 17501</b> 	AB4210D	<b>21"</b> 533.40mm	<b>33/50"</b> 16.6mm			<b>2"</b> 50.8mm	<b>.158"</b> 4.0mm	High Lift Blade. Fits EGO Power+ 42" Z6 Zero Turn Riding Mower ZT4207L.
<b>Blades for EXMARK</b>								
<b>15 - 11495-6</b> 	103-6402 103-6402-S	<b>18"</b> 457.20mm	<b>15/16"</b> 23.8mm			<b>2-1/2"</b> 63.5mm	<b>.204"</b> 5.1mm	<b>Heavy Duty Boxed Blade.</b> (6) of our <b>15-11495</b> (2) Blades for 36" Cut (3) for 52" Cut. Notched Hi-Lift. Ideal for Commercial Cutters. Painted Red.

ORDER NO.		Replaces O.E.M No.	Length	Center Hole Diam.	Outside Hole Diam.	Center to Center	Width	Steel Thick	Application
<b>Blades for EXMARK (cont.)</b>									
<b>15 - 11242-6</b>		103-6393 103-6393-S	<b>20-1/2"</b> 520.70mm	<b>15/16"</b> 23.8mm			<b>3"</b> 76.2mm	<b>.204"</b> 5.1mm	<b>Heavy Duty Boxed Blade.</b> (6) of our <b>15-11242</b> (3) for 60" Lazer. Ideal for Commercial Cutters. <b>Mulching Blade.</b>
<b>Blades for FERRIS</b>									
<b>15 - 17502</b>		51055112S	<b>16-1/4"</b> 412.8mm	<b>13/16"</b> 20.6mm			<b>2-1/2"</b> 63.5mm	<b>.204"</b> 5.1mm	Fits 400S series models. (3) blades for 48" deck.
<b>Blades for KUBOTA</b>									
<b>15 - 17246</b>		K5975-34360	<b>24-1/2"</b> 622.30mm	<b>1-5/16"</b> 33.3mm			<b>3"</b> 76.2mm	<b>.250"</b> 6.4mm	<b>COPPERHEAD®</b> <b>Mulching Blade.</b> (3) blades for 72".
<b>Blades for MTD</b>									
<b>15 - 17514</b>		742P05019	<b>23"</b> 584.2mm	<b>Bowtie</b>			<b>2-1/4"</b> 57.2mm	<b>.134"</b> 3.4mm	3-in-1 blade for walk-behind mower. Fits Cub Cadet models 12ABR2MM710 and 12ABR27B710. Fits MTD models 12ABQ2MM897, 12ABR27B791, 12ABQ2BH707 and others.
<b>Blades for SPARTAN</b>									
<b>15 - 17520</b>		438-0001-00	<b>18-1/2"</b> 469.9mm	<b>5/8"</b> 15.9mm			<b>2-1/2"</b> 63.5mm	<b>.250"</b> 6.4mm	Fits all Spartan 54" decks. Used on model series RZ Pro, RT Pro, RT HD, SRT Pro, SRT HD and Mark Martin SRT edition.
<b>15 - 17521</b>		438-0002-00	<b>21"</b> 533.40mm	<b>5/8"</b> 15.9mm			<b>2-1/2"</b> 63.5mm	<b>.250"</b> 6.4mm	Fits all Spartan 61" decks. Used on models RZ Pro, RT Pro, RT HD, SRT HD, SRT XD, Mark Martin SRT edition.

ORDER NO.		Replaces O.E.M No.	Length	Center Hole Diam.	Outside Hole Diam.	Center to Center	Width	Steel Thick	Application
<b>Blades for TORO</b>									
<b>15 - 17506</b>		115-9649-03	<b>20-1/2"</b> 520.7mm	<b>5/8"</b> 15.9mm			<b>2-1/2"</b> 63.5mm	<b>.187"</b> 4.7mm	Notched Hi-Lift. Fits 60" Z Masters.
<b>15 - 17503</b>		137-1999-03	<b>21.6"</b> 548.6mm	<b>5/8"</b> 15.9mm			<b>2-3/4"</b> 69.9mm	<b>.187"</b> 4.7mm	Fits 42" Time Cutters.
<b>15 - 17504</b>		131-3939-03	<b>21.6"</b> 548.6mm	<b>5/8"</b> 15.9mm			<b>2-1/4"</b> 57.2mm	<b>.187"</b> 4.7mm	Fits 42" Time Cutters.

ORDER NO.		Replaces O.E.M No.	Length	Center Hole Diam.	Outside Hole Diam.	Center to Center	Width	Steel Thick	Application
<b>EDGER BLADES</b>									
<b>16 - 17552</b>		Echo 720237001	<b>11.687"</b> 296.84mm	<b>1"</b> 25.4mm			<b>2"</b> 50.8mm	<b>.125"</b> 3.2mm	Unsharpened, Non-Heat Treated Edger Blade Also replaces Maruyama 216062 & 840084, Ryobi 613223, and Stihl 4133-713-4101. Painted black. Compare to Rotary <b>16-6477</b> .

**Hydro Oil Filter For GRASSHOPPER**

ID 3/4 - 16 (19.05mm)  
OD 3" (76.2mm)  
Height 4" (101.6mm)

**Order No. 19 - 17767**

High efficiency hydraulic oil filter replaces Grasshopper 100855. Micron rating 10. Threads 3/4-16. Used on models 120, 124, 218, 220, 225, 223, 227 and many more.

**Filter Safety Element For ENGINEAIRE**

**Order No. 19 - 10080**

Filter Safety Element for Engineaire. Fits John Deere M807331, M123378, Kohler 25 083 03-S, 2508303S, 25-083-03-S, Kubota K7561-82360 and Toro 98-2982. Used with Rotary **19-9616** & **19-11842**.

**Air Filter Kit For KOHLER**

ID 1-1/2" (38.10mm)  
OD 3" (76.20mm)  
Height 5-1/4" (133.35mm)

**Order No. 19 - 17466**

Air Filter replaces Kohler 2288301S. Air Filter Kohler 2208301S and Prefilter Kohler 2208304S. Fits Kohler 5400 Series Engine.

**Hydro Filter Kit For TORO**

OD 1.32" (33.52mm)  
Length 3.89" (98.80mm)

**Order No. 19 - 17623**

Hydro Filter Kit replaces Toro 144-3842, 132-4743 and 136-5409. Fits 48", 52" and 60" Grandstand mowers. Contains two filters, two o-rings, and two springs.

**NEW**

**HELIX Double Wire Hose Clamps**



Order No.	Description
<b>20 - 17695</b>	Double wire hose clamps for 5/16" hose. Packaged in lots of 15
<b>20 - 17697</b>	Double wire hose clamps for 3/8" hose. Packaged in lots of 15
<b>20 - 17696</b>	Double wire hose clamps for 7/16" hose. Packaged in lots of 15

**18" Vinyl High Back Seat**

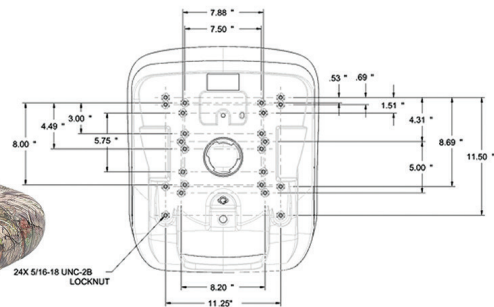

**Order No. 21 - 17763**

18" High back camo vinyl, 24 inserts, universal bolt pattern. Corrosion resistant, central drain. Accepts two screw safety switch. Fits lawn mowers, Gators, and utility vehicles.

**Carburetor For BRIGGS & STRATTON**



**Order No. 22 - 17522**

Carburetor replaces B&S 591852. Fits models 100602 and 100802.

**Carburetor For BRIGGS & STRATTON**



**Order No. 22 - 17523**

Carburetor replaces B&S 799727 and 690194.

**Carburetor For BRIGGS & STRATTON**



**Order No. 22 - 17524**

Carburetor replaces B&S 699709 and 791230. Fits models 405777 and 406777.

**Carburetor For  
BRIGGS & STRATTON**

**Order No. 22 - 17525**

Carburetor replaces B&S 798653. Fits models 111412, 120412, 126402, and 120202.

**Carburetor For  
KAWASAKI**

**Order No. 22 - 17530**

Carburetor replaces Kawasaki 15004-0953, 15004-2943.

**Carburetor For  
KAWASAKI**

**Order No. 22 - 17531**

Carburetor replaces Kawasaki 15004-1011. Fits model FX370V.

**Carburetor For  
KOHLER**

**Order No. 22 - 17529**

Carburetor replaces Kohler 2085333S. Fits models SV470, SV480, and SV530.

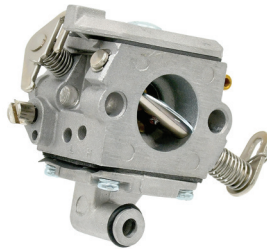
**Carburetor For  
STIHL**

**Order No. 22 - 17526**

Carburetor replaces Stihl 1130-120-0603. Fits MS170, MS180, and MS210 chainsaws.

**Carburetor For  
STIHL**

**Order No. 22 - 17527**

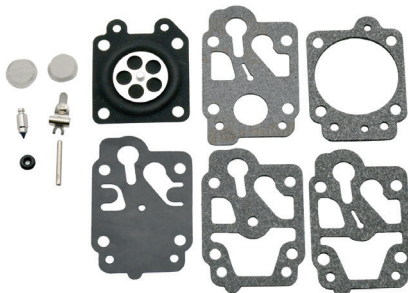
Carburetor replaces Stihl 1127-120-0604. Fits 029 and MS290 chainsaws.

**Carburetor Kit For  
WALBRO**

**Order No. 22 - 17532**

Carburetor Overhaul Kit replaces Walbro K10-WYB.

**Carburetor Kit For  
WALBRO**

**Order No. 22 - 17533**

Carburetor Kit replaces Walbro K20-WYA.

**NEW**

**Carburetor Kit For WALBRO**



**Order No. 22 - 17534**   
 Carburetor Kit replaces Walbro K24-WAT.

**Metering Diaphragm For WALBRO**



**Order No. 22 - 17535**   
 Metering Diaphragm replaces Walbro 95-586-8.

**Fuel Module Assembly for BRIGGS & STRATTON**



**Order No. 22 - 17551**   
 Fuel Module Assembly replaces Briggs & Stratton 596523.

**NGK Spark Plug**



**Order No. 24 - 17686**   
 NGK Spark Plug BPR7ES. MIN 04

**Rear Grass Bag for EXMARK**



**Order No. 28 - 16741**   
 Rear Bag replaces Exmark 103-0431, 1-653566 and 116-0757. This replacement bag is for the Exmark 2-bag and 3-bag rear rider catchers. The bag is made with black polyester material and has a back plastic pan and closely resembles the OEM product.

**Grass Bag for EXMARK**



**Order No. 28 - 8979**   
 Fits Encore, Exmark, Jacobsen, FD Kees, Ariens & Gravely. (Black).

**Rear Grass Bag for SCAG**

**Order No. 28 - 16727**   
 Rear Bag replaces Scag 482569 and 462968. Length 189" (4800.60mm) x Width 5/8" (15.87mm).

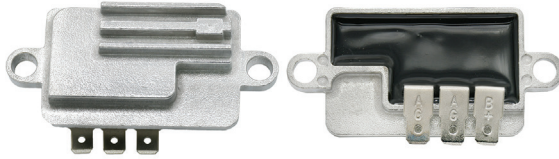

**Voltage Regulator for  
KAWASAKI**

**Order No. 31 - 17505** ⚠️

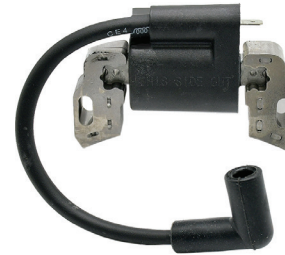
Voltage Regulator 20amp replaces Kawasaki 21066-0810 and 21066-0740. Fits models FX730, 600, 691, 751, 801, 850, 921, FXT100, and many more.

**Ignition Coil for  
BRIGGS & STRATTON**

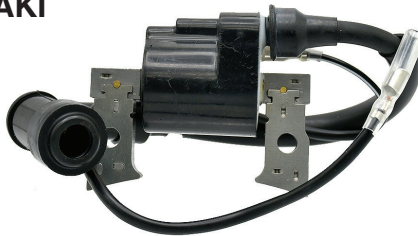
**Order No. 31 - 17542** ⚠️

Ignition Coil replaces B&S 84005272, old numbers 799582, 593872, 595009. Fits models 08P502, 09P602, 09P702.

**Ignition Coil for  
KAWASAKI**

**Order No. 31 - 17543** ⚠️

Ignition Coil replaces Kawasaki 21121-2086. Fits models FB460V, FC401V and FC420V. Also replaces John Deere AM121820.

**Ignition Coil for  
KAWASAKI**

**Order No. 31 - 17544** ⚠️

Ignition Coil replaces Kawasaki 21171-0743. Fits models FX751V, FX801V and FX850V.

**Ignition Coil for  
KOHLER**

**Order No. 31 - 17545** ⚠️

Ignition Coil replaces Kohler 12-584-04-S and 12-584-01-S. Fits models CH11, CH12.5, CH14, CH15, CV11, CV12.5, CV14 and others.

**Ignition Coil for  
KOHLER**

**Order No. 31 - 17546** ⚠️

Ignition Coil replaces Kohler 20-584-03, 20-584-01-S and 20-584-04-S. Fits models SV470, SV471, SV480, SV530, SV540, SV541 and SV590.

**Stator for  
BRIGGS & STRATTON**

**Order No. 31 - 17548** ⚠️

Stator 10-16 amp regulated, replaces B&S 592830, 393295, 691064. Fits select models 21R707, 285H77, 295347, 295777, 296447, 297347, 303442 any many others. Consult your parts manual for correct application.

**FLOTOOL 3 Piece Funnel Set**

**Order No. 32 - 17481**

FloTool 3 Piece Funnel Set includes 1 each, 1/2 pt, 1 pt, and 2 qt funnels.

**NEW**

**Foot Actuated Air Pump from HELIX**



**Order No. 32 - 17690** ⚠️

Helix Foot Actuated Air Pump with gauge. Features easy release thumb lock chuck, adjustable marker on gauge, steel construction, braided hose and needle adaptor for sports equipment.

**Heavy Duty Spring Pull from HELIX**



**Order No. 32 - 17691** ⚠️

Helix HD Spring Pull Tool is ideal for removing tough springs. Also use on cotter pins, seat or tank holding springs, side-stand springs and many others. Knurled handle for sure grip.

**Valve Stem Tool from HELIX**



**Order No. 32 - 17692**

Helix Valve Stem Installation Tool with swivel end. Eleven inches in length for excellent leverage. Knurled handle for sure grip. Makes valve stem installation a breeze.

**Metric Allen Wrench Set from HELIX**



**Order No. 32 - 17693**

Metric Allen Wrench Set with holder. Set includes 8 wrenches ranging from 1.5mm to 10mm.

**Safety Wire from HELIX**



**Order No. 32 - 17694** ⚠️

Stainless Steel Safety Wire .032" x 90'.

**Super Duty Cable Ties for HELIX**



Order No.	Description
⚠️ 32 - 17698	9" reusable cable ties. 1/4" wide. Packaged in lots of 6.
⚠️ 32 - 17699	20" reusable cable ties. 1/4" wide. Packaged in lots of 6.

**Wire Loom for HELIX**



Order No.	Description
⚠️ 32 - 17687	3/8" Wire Loom. Use to contain and secure loose wiring for safety and a professional look. 6 feet long
⚠️ 32 - 17688	1/2" Wire Loom. Use to contain and secure loose wiring for safety and a professional look. 6 feet long
⚠️ 32 - 17689	3/4" Wire Loom. Use to contain and secure loose wiring for safety and a professional look. 6 feet long

**"00" Grease**



**Order No. 33 - 17470**

NLGI 00 Grade Grease, is made from lithium hydroxy stearate and additives that give it adequate performance of machinery, among other equipment. **Sold in single 32oz quart bottles.**

**SAE 10W-40 OIL from CASTROL**



**Order No. 33 - 219046** ⚠️

Castrol SAE 10W-40 Oil 32oz. Meets or exceeds API SL. Zinc boosted to reduce engine wear. Formulated specifically for use in Outdoor Power Equipment. (12 bottles per case) MIN 012

**SAE 20W-50 OIL from CASTROL**



**Order No. 33 - 219047** ⚠️

Castrol SAE 20W-50 Oil 32oz. Meets or exceeds API SL. Zinc boosted to reduce engine wear. Formulated for higher temperatures, specifically for use in high horsepower Outdoor Power Equipment. (12 bottles per case) MIN 012

**SAE 20W-50 Hydrostatic Transmission Fluid From CASTROL**



**Order No. 33 - 219048** ⚠️

Castrol 20W-50 Hydro Trans Fluid 32oz. All season formula protects in all temperatures, Shear stable formula resists oxidation and corrosion. Maximum wear protection for extended life. (12 bottles per case) MIN 012

**VP Racing Motorsport 5.5 Gallon Container**



**Order No. 33 - 3846-CA**

VP Racing Motorsport Camo 5.5 Gallon Container. Includes Rotary 33-17329 Deluxe Hose. Features an ergonomic handle for better venting and a super wide handlegrip on bottom for easy pouring. Excellent for storage and transport of recyclable automotive fluids, non-potable water, feed attractants and other outdoor products. Note, this MUST NOT be used to transport fuel or kerosene. (Camo)

**Utility Jug Cap with O-ring for VP**



**Order No. 33 - 17556**

VP Utility Jug Replacement Cap with O-Ring. Fits Rotary No. 33-3943, 33-3953, and 33-3536-CA Utility Jugs.

**Utility Jug Large O-Ring for VP**



**Order No. 33 - 17558**

VP Utility Jug Replacement Large O-Ring. Fits Rotary No. 33-3943, 33-3953, and 33-3536-CA Utility Jugs.

**Utility Jug Vent Cap for VP**

**Order No. 33 - 17557**

VP Utility Jug Replacement Vent Cap. Fits Rotary No. 33-3943, 33-3953, and 33-3536-CA Utility Jugs.



**NEW**

## Mist-Pro Blower / Fogger

### Order No. 33 - 17659

Mist-Pro Blower / Fogger combines two tools you already own, any leaf blower and tank sprayer, to create a high-powered mist sprayer so you can spray like a pro. Spray up to 40 feet vertically and into hard-to-reach areas. Spray large areas quickly with minimal solution, saving time and money.



# ROTARY

# SAW CHAIN CUT LOOPS



Pitch	Gauge	Drive Links	ROTARY SAW CHAIN	
			Order No.	
<b>.325" X .043 (Semi-Chisel) - Bumper Links</b>				
.325"	.043	51	<b>34 - 7311051</b>	⚠
.325"	.043	59	<b>34 - 7311059</b>	⚠
.325"	.043	64	<b>34 - 7311064</b>	⚠
<b>3/8" X .050 (Full Chisel) - w/o Bumper Links</b>				
3/8"	.050	81	<b>34 - 7424081</b>	⚠

## HARVESTER SAW CHAIN (Semi-Chisel) Cut Loops



Pitch	Gauge	Drive Links	ROTARY HARVESTER SAW CHAIN	Replaces Oregon Part No.	Manufacturer and Model Numbers
			Order No.		
<b>3/4" X .122 Semi Chisel - w/o Bumper Link</b>					
3/4"	.122	55	<b>34 - 7666055</b> ⚠	11H055E	Caterpillar PF-48
3/4"	.122	56	<b>34 - 7666056</b> ⚠	11H056E	BARKO: CF22, CTR: 260 STUMPER, 314-TSC, 400, 450, 500, 500 DELIMBER, HULDINS: SUPERCUT 150, SUPERCUT 300, SUPERFELL 851, SUPERSAW 6000S, SKIDMORE: CF-19, CF-20, CF-22, LAKO: 750 PREMIO, LAKO FOREST: 750 PREMIO, LOGMAX: 9000, PIERCE PACIFIC: PTH-24, SOUTHSTAR: QS600, TIMBER HEADS: TH24F, TIGERCAT: 575, WARATAH: HTH623C
3/4"	.122	57	<b>34 - 7666057</b> ⚠	11H057E	CATERPILLAR: PRENTICE PD-57, FABTEK: FT-180, HYTEC: RS 6000, RS6000, SATCO: 223, 420, SOUTHSTAR: TS585, WARATAH: HTH-24, HTH624
3/4"	.122	59	<b>34 - 7666059</b> ⚠	11H059E	CTR: 550, WARATAH: HTH-22, HTH-234, HTH-26, HTH626
3/4"	.122	60	<b>34 - 7666060</b> ⚠	11H060E	CSI: PTD-143, PTD-243
3/4"	.122	63	<b>34 - 7666063</b> ⚠	11H063E	JOHN DEERE: HTH 625C, MULTITEK: 2025XFC, 2040 XP-90, 2040 XP2, 2040XP-90, 3040 XP-90, 3040XP-90

3/4" uses 5/16" file for sharpening

# HARVESTER CHAIN SAW Rim Sprockets

**NEW**

**36-17536**

**36-17537**

**36-17538**

Pitch	Desc.	GA.	Bore	No. Teeth	ROTARY HARVESTER SPROCKET	
					Order No.	
<b>.404 Drive Sprocket</b>						
.404	Drive Sprocket	.080"	25mm	14	<b>36 - 17536</b>	⚠
.404	Drive Sprocket	.080"	25mm	16	<b>36 - 17537</b>	⚠
.404	Drive Sprocket	.080"	25mm	18	<b>36 - 17538</b>	⚠

## Intake Manifold for STIHL



### Order No. 38 - 17492 ⚠

Bottom Intake Manifold replaces Stihl 4238-141-2203. Fits Stihl models TS410, TS420 and TS440 concrete saws.

## Intake Manifold for STIHL



### Order No. 38 - 17493 ⚠

Upper Intake Manifold replaces Stihl 4238-141-2202. Fits models TS410, TS420 and TS440 concrete saws.

## Molded Fuel Hose for STIHL



### Order No. 38 - 17494 ⚠

Molded Fuel Pick up Hose replaces Stihl 4238-358-7700. Fits models TS410, TS420 and TS440 concrete saws.

## Fuel Hose Connector for STIHL



### Order No. 38 - 17495 ⚠

Fuel Hose Connector replaces Stihl 4238-353-2701. Fits models TS410, TS420 and TS440 concrete saws.

**NEW**

**Fuel Hose Connector Grommet for STIHL**



**Order No. 38 - 17496**

Fuel Hose Connector Grommet replaces Stihl 4238-353-9200. Fits models TS410, TS420 and TS440 concrete saws.

**Gasket Set for STIHL**



**Order No. 38 - 17497**

Gasket Set with seals replaces Stihl 4238-007-1003. Fits models TS410, TS420 and TS440 concrete saws.

**Compression Release for STIHL**



**Order No. 38 - 17498**

Compression Release replaces Stihl 4223-020-9400 and 4238-020-9400. Fits models TS410, TS420, TS700 and TS800 concrete saws.

**Poly-V Belt Drive for STIHL**



**Order No. 38 - 17499**

Poly-V Belt Drive replaces Stihl 4238-760-8500. Fits models TS410 and TS420 concrete saws.

## Drenaline Climbing Rope from TEUFELBERGER

The Drenaline Climbing Rope is either on single or double rope configurations, this rope gives ultimate freedom to the climber to choose the right technique for the task. Its extremely light construction and 32 strand cover allows super smooth precision during ascents and descents. 200' long, 11.8mm diameter, 20kN MBS, with splife.



Rotary #	OEM	MBS	Rope Dia.	Length	Construction	Eye Option	Color
43 - 17555	KIT-EDRN200	4496 lbs / 20 kN	.47" / 11.8mm	200'	32-Strand Polyester Cover, Nylon Core	1 Eye	Multi
43 - 17702	KIT-EDRN150	4496 lbs / 20 kN	.47" / 11.8mm	150'	32-Strand Polyester Cover, Nylon Core	1 Eye	Multi

## True-Blue Braided Climbing Rope from SAMSON

True-Blue braided climbing rope is a unique combination of extrusion set blue polyester fibers, wrapped over a white polyester core, in a Samson 12-strand dura-tite braid.



Rotary #	OEM	ABS	Rope Dia.	Length	Construction	Color
43 - 17750	TRBL-200-NS	7300 lbs / 32.5 kN	0.50" / 12.7mm	200'	12-Strand dura-tite Polyester Core	Blue

## Danube Climbing Rope from SAMSON

Arborfreak climbing rope from Samson offers low stretch, high strength construction. Danube 16 strand abrasion resistant polyester cover over high strength nylon core.

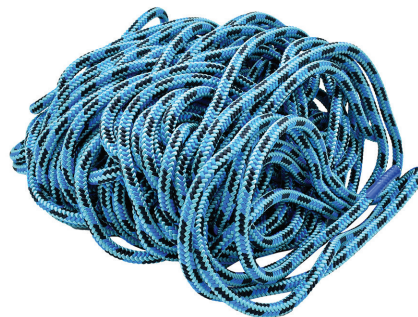

Rotary #	OEM	ABS	Rope Dia.	Length	Construction	Color
43 - 17757	ARBFK-DU-200-NS	8100 lbs / 36 kN	0.50" / 12.7mm	200'	16-Strand Polyester Cover, Nylon Core	Blue/Black

**NEW**

**Kraken Rigging Rope from STERLING**

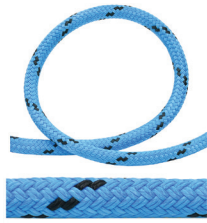

43 - 17745



43 - 17746



43 - 17747



43 - 17748

Kraken is a monster rigging line, ready to take on your biggest, toughest rigging jobs. At the heart of Kraken is a polyester core, giving it its high strength and robust feel. The jacket is a tight braided polyester that gives Kraken amazing durability, without making it feel brittle.



Rotary #	OEM	ABS	Rope Dia.	Length	Color
43 - 17745	KRKN12-200-NS	9500 lbs	1/2"	200'	Blue
43 - 17746	KRKN34-200-NS	18,400 lbs	3/4"	200'	Green
43 - 17747	KRKN58-200-NS	16,000 lbs	5/8"	200'	Yellow
43 - 17748	KRKN78-200-NS	28,900 lbs	7/8"	200'	Orange

**Stable Double Braid Rigging Rope from SAMSON**



43 - 17758



43 - 17759



43 - 17760

Stable double braid bull rope from Samson offers low stretch, high strength-to-weight ratio, and torque-free construction



Rotary #	OEM	MBS	Rope Dia.	Thickness	Length	Construction	Color
43 - 17758	STB916-200-NS	11,300 lbs	9/16"	0.625" / 15.875mm	200'	24-Strand Polyester Core	Red
43 - 17759	STB58-200-NS	13,900 lbs	5/8"	0.625" / 15.875mm	200'	24-Strand Polyester Core	Yellow
43 - 17760	STB34-200-NS	17,300 lbs	3/4"	0.75" / 19.05mm	200'	24-Strand Polyester Core	Green

## Whoopie Sling Rope from ROPE LOGIC



The Rope Logic Whoopie is a time-tested design that allows workers to mount hardware snugly against a tree in seconds. Made with Samson Tenex-Tec rope. 3/4" rope with adjustable length from 4 to 12 feet.

Rotary #	OEM	WLL	Rope Dia.	Length	Color
43 - 17744	30295	3380 lbs	3/4"	4 to 12 ft	Green



## X Ring Rigging Sling from ROPE LOGIC



Rigging X sling, 3/4" by 10' with ring. Rings are made of hard-coat anodized aluminum for high strength. Working load limit is 2200 pounds.

Rotary #	OEM	WLL	Rope Dia.	Length	Color
43 - 17755	36650	2200 lbs	3/4"	10 ft	Green



## X Rigging Sling from ROPE LOGIC



Rigging X sling, 3/4" by 12' with eye ring. Rings are made of hard-coat anodized aluminum for high strength. Spliced with 3/4" Tenex from Samson. Working load limit is 2200 pounds.

Rotary #	OEM	WLL	Rope Dia.	Length	Color
43 - 17756	35800	2200 lbs	3/4"	12 ft	Green



## Flipline Glide Rope Grab from NOTCH



43-17710

Wirecore flipline features the Notch Glide Rope Grab.



Rotary #	OEM	Length
43 - 17710	99322	1/2" x 10'

## Lanyard Glide Rope Grab from NOTCH



43-17711

This adjustable lanyard features the Notch Glide Rope Grab with Yale 11.7 mm. Tropical Ivy 24-Strand rope.



Rotary #	OEM	Length
43 - 17711	99326	10'

**NEW**

## PulleySAVER from TEUFELBERGER



Rotary #	OEM	Standards	Rope Dia.	MBS
43 - 17468	T7350835	EN785B, ANSI Z133.1-2006	12mm	5,485 lbs / 45.1kN

The PulleySAVER epitomizes the evolution of the friction saver. The pulleySAVER can be used as anchor point on a tree and can be configured four different ways: 1. Swinging element in a double leg configuration, 2. Choke Hitch, 3. Wound around in a double leg configuration, 4. Narrowed in a double leg configuration.

## Hitch Climber Pulley Kit Pro Combo

**Order No. 43 - 17553**



The Hitch Climber Pulley Kit Pro Combo. Kit contains One Hitch Pulley (red) Rotary No. 43-17345, Two USR ProClimb Aluminum Oval Carabiners Rotary No. 43-16792 and 3/8" Teufelbuerber Red/Yellow 32" prusik Rotary No. 43-17357. Everything you need to start climbing.



## RIGGING BLOCK WITH ULTRA SLING FOR ROPE LOGIC

Rotary #	OEM
43 - 17738	51257



The orange Rope Logic 5/8" Ultra Sling with Notch 1/2" Rigging Block is a small sized lightweight arborist block that accepts working lines up to 1/2" (13mm) diameter. It has 6 - 6" pockets, 6 feet of usable length and 7 feet overall.



43-17738

## Stainless Steel Portawrap Whoopie Sling From NOTCH

Rotary #	OEM
43 - 17739	KIT31



This Includes a large-sized stainless steel Portawrap and hand-spliced, all-polyester adjustable Whoopie sling. The Whoopie sling can be adjusted short (4-ft) to long (12-ft) with its special adjustment feature.



43-17739

## Quick Cinch Chainsaw Lanyard from NOTCH



The Notch Quick Cinch Chainsaw Lanyard allows maximum reach and minimum fuss for attaching to all saw types and sizes.

Rotary #	OEM
43 - 17742	NQCCL-17MM



43-17742

## Chainsaw Lanyard from PROCLIMB



The ProClimb Chainsaw Lanyard features 5 feet of extension, giving you full arm reach and maximum mobility while contracting to just 21 inches. Supports up to 15 lbs. Fits a variety of top handle saws. Built to ANSI 121-2018 standards. Length 21" to 60".



43-17754

Rotary #	OEM	Standards
43 - 17754	DP-5013	ANSI 121-2018

## Rope Runner Vertec from NOTCH



The ultimate climbing device smooth operation and tool-free adjustment. The next generation in the Rope Runner series.



43-17709

Rotary #	OEM
43 - 17709	99703

## Rigging Block from NOTCH



43 - 17740

The orange Notch 1/2" Rigging Block is a small sized lightweight arborist block accepts working lines up to 1/2" (13mm) diameter.



43 - 17741

This is the must have rigging and impact block for tree care. The aluminum Notch Rigging Block accepts up to a 3/4" rigging line and features rounded edges making it very rope friendly. The spring action lock makes for a secure connection between the side plates.

Rotary #	OEM	Max Sling Dia.	WLL	Color	lbs.	Rope / in.	Rope / mm
43 - 17740	55352	5/8"	20 kN	Orange	1	1/2"	13mm
43 - 17741	56130	1-1/8"	30kN	Red	3.6	3/4"	19.05mm



## Speed Line Kit from NOTCH



Rotary #	OEM	Length	Color
43 - 17743	NSL40KIT6	40"	Green



The Notch Speedline Kit has aluminum double-action snap hooks girth hitched to a 40" tubular Nylon sling for easy replacement and long service life. Includes a set of 6 and the speed rack for easy carry.

**NEW**

## Skyshot ProThrowbag from STEIN

**STEIN**

Rotary #	OEM	Ring Size	Weight	Color
<b>Vinyl Throwbag</b>				
43 - 17473	280	1"	10 oz.	Blue / Pink
43 - 17474	340	1"	12 oz.	Blue / Orange
43 - 17475	400	1"	14 oz.	Blue / Green
43 - 17476	460	1"	16 oz.	Blue / Yellow



43 - 17473



43 - 17475



43 - 17474



43 - 17476

The Stein SKYSHOT PRO is manufactured in the USA using precision laser cut Cordura Fabric; this process heat seals all the cut edges preventing fraying internally during use. It has an aerodynamic design to help increase your throw distance and punch through the tree canopy.

## Throw Weight from NOTCH

**NOTCH**

Rotary #	OEM	Weight	Color
<b>Throw Weights</b>			
43 - 17727	NTW2-8	8 oz.	Red / Teal
43 - 17723	NTW2-10	10 oz.	Purple / Teal
43 - 17724	NTW2-12	12 oz.	Pink / Teal
43 - 17725	NTW2-14	14 oz.	Lime Green / Teal
43 - 17726	NTW2-16	16 oz.	Orange / Teal



43 - 17727



43 - 17723



43 - 17724



43 - 17725



43 - 17726

This Notch lead-free throw weight features a bright colored design and is color-coded according to size. The high-vis pattern will stand out against any background.

## Acculine Throwline



43 - 17721



43 - 17722

**NOTCH**

Rotary #	OEM	Size	Length	Color
43 - 17721	NTL 175-180	1.75mm	180'	Yellow
43 - 17722	NTL22-180	2.2mm	180'	Orange

Notch Acculine is a high strength, durable throwline made with Dyneema® fiber. This high-tech fiber isn't just strong - it's also low stretch and lightweight. The urethane coating adds a high degree of abrasion resistance, and the high-visibility color means you'll never lose track of your throw line. Length 180'.

## NYLON LOOP RUNNER FROM NOTCH



**NOTCH**

Rotary #	OEM	Color	cm/length	mm/width
43 - 17753	NNLR-36	Orange	36" / 91.4	1" / 25.4

Orange 36" nylon loop runner by notch. Made of 1" wide nylon tubular material with heavy duty stitching. Bright and fade resistant coloration.

## Universal Helmet Clamp Kit from SENA

**Order No. 43 - 17712** ⚠️

Helmet clamp kit for the Sena 30K Bluetooth headset, 20S EVO Bluetooth Headset, and the 20S Bluetooth Headset. Slim speakers are more accommodating in helmets that lack deep speaker pockets or have an overall tight fit.



43 - 17712

## Work 4 Pro Bulk Pack from SENA

**Order No. 43 - 17713** ⚠️

This amazing wireless intercom system utilizes state-of-the-art Bluetooth 4.1 technology to provide a crystal clear link between up to 4 workers, revolutionizing communication, safety, and efficiency.



43 - 17713

## 33i+ Comm System from SENA

**Order No. 43 - 17714** ⚠️

The Sena 33i Bluetooth Comm System is the perfect communication system for the professional. One click of a button instantaneously connects to a virtually limitless amount of 33i users within a one-mile range via mesh-network technology.



43 - 17714

## PROTOS Arborist Helmet from PFANNER



43 - 17717



43 - 17719



43 - 17718



43 - 17720

Rotary #	OEM	Standards	Color
<b>PROTOS Arborist Helment</b>			
⚠️ 43 - 17717	PROTOS-NYCB	ANSI 289.1 EN 397, 12492	Neon Yellow
⚠️ 43 - 17719	PROTOS-ONY	ANSI 289.1 EN 397, 12492	Orange / Neon Yellow
<b>PROTOS Arborist Helment w/Sena 33i Installed</b>			
⚠️ 43 - 17718	PROTOS-NYCB-99615-397	ANSI 289.1 EN 397, 12492	Neon Yellow
⚠️ 43 - 17720	PROTOS-ONY-99615-39786	ANSI 289.1 EN 397, 12492	Orange / Neon Yellow

The Protos arborist helmet from Pfanner is the most advanced helmet system available on the market offering the best energy absorption, lightest weight, and unprecedented breath-ability. The side impact protection sets it apart from its competitors and makes it arguably the safest climbing helmet ever brought to market.

**NEW**

## Ergo Tree Gaffs from NOTCH

**NOTCH**

These lightweight Notch Ergo tree gaffs are optimized for all-day comfort. The steel shank is angled for a more natural fit with your foot and leg, and the oversized cuff and improved padding reduce pressure points. **(Pair)**



Rotary #	OEM	Standards	Weight Rated
<b>Steel Tree Climber Gaffs</b>			
43 - 17749	99695T	ASTM F887	350 lbs.

## TreeMOTION Harness Pro from TEUFELBERGER

**Teufelberger**

TreeMOTION Pro harnesses are customized to accommodate a wide variety of climbing styles and is ready for the next generation of tree climbers. Features include quick release buckles, four attachment points and improved comfort padding.



Rotary #	OEM	Waist Belt	Leg Loops
43 - 17467	T7350316	79cm - 104cm / 31" - 41"	43cm - 71cm / 17" - 28"

## Catalyst Harness from NOTCH

**NOTCH**

The Catalyst Harness is ultra-comfortable and packed with features. The Catalyst is the most comfortable harness on the market. The custom EVA molded back, and leg panels feature integrated ventilation channels for comfort and breathability.



Rotary #	OEM	Size	Waist Belt	Leg Loops
43 - 17715	CATH-1	1	80cm - 110cm / 31" - 43"	60cm - 75cm / 23" - 29"
43 - 17716	CATH-2	2	96cm - 132cm / 38" - 52"	66cm - 82cm / 26" - 32"

## Throw Line Kit from NOTCH

**43 - 17751**

**43 - 17752**

Rotary #	OEM	Description
<b>43 - 17751</b>	32395	Kit Contains <b>(43-17722)</b> 200' of throwline, <b>(43-17752)</b> folding cube, <b>(43-17724)</b> 12oz. Throw weight and <b>(43-17725)</b> 14oz. Throw weight.
<b>43 - 17752</b>	32443	Foldable Throw Line Cube. Holds up to 2 throwlines while keeping ends isolated and organized, 4 weights, and various accessories. Folds to compact portable size.

## Climbing Kit

### Order No. **43 - 17516**

Climbing Kit with Rotary Duffle Bag. Everything you need to start climbing, all in one bag. This kit contains: duffle bag, climbing rope, foot ascender, flip line, 3-pack of carabiners, blood stopper kit, rope bag, throw line, foldable throw line cube, prusik, 12 oz. and 16 oz. throw bags and accessory carabiner.



## ROTARY Duffle Bag

Rotary #	Size	Color
<b>50 - 17515</b>	24" x 12"	Black

Rotary Duffle Bag is a 24" x 12" canvas barrel bag with zipper and handles. This multi-purpose black bag has a large, red Rotary Logo and is used in our **43-17516** Arbor Climbing Kit.



## Hauler 70L Bag from NOTCH

Rotary #	OEM	Color
<b>43 - 17707</b>	99715	Black

Notch Hauler 70L Bag is a free standing backpack with thoughtfully designed compartments to help get all your gear from the truck to the job site. Designed with the input from working arborist, this bag is ultra rugged and weatherproofed, and loaded with features.



**NEW**

## Bypass Pruning Shears from VESCO



VESCO

Rotary #	Pole Type	OEM
 43 - 17482	Bypass Pruning Shears	A1

The A1 Vesco Bypass pruning shears are once a familiar and standard design, yet with details that set them apart from even the best in the industry. Includes shock absorbing pads and high-carbon blades that are both fully hot-forged and tempered.

## Curved Anvil Pruning Shears from VESCO



VESCO

Rotary #	Pole Type	OEM
 43 - 17483	Curved Anvil Pruning Shears	A6

The A6 Vesco Curved Anvil pruning shears are characterized by grazing cuts leaving no protrusion on the pruned surface. The curved anvil helps hold the branch in place, and the blade moves back as it cuts. Also has high-carbon blades that are both fully hot-forged and tempered.

## Multi Purpose Sheath from VESCO



VESCO

Rotary #	Pole Type	OEM
 43 - 17484	Multi Purpose Sheath	F5

The F5 Vesco Multi purpose sheath is a real leather sheath for pruning shears, with a belt loop. It is very handy because it can be worn vertically or horizontally, meeting the operators requirements. Use with our No. **43-17482 & 43-17483**.

## Sharpening Stone from VESCO



VESCO

Rotary #	Pole Type	OEM
 43 - 17485	Shaped Sharpening Stone	F2

The F2 Vesco shaped sharpening stone is a medium-grained sharpened stone. This stone has a special shape in order to make the sharpening of all curved blades easier. It is particularly suitable for sharpening traditional pruning shears.

## Folding Handsaw from VESCO

Rotary #	Description	OEM	Size	Thickness
43 - 17488	Vesco folding handsaw	C10	8"	.0460" / 1.16mm



Vesco folding handsaw includes a folding lock that makes this saw safe and handy. The blade has a three-sided cutting edge and tempered teeth. Also has smooth side surface that improves the performance during cutting helping to avoid infections and ensures healing of the plant.

## Curved Handsaws from VESCO



43-17477



43-17489

Rotary #	Description	OEM	Size	Thickness
43 - 17477	11" Vesco curved handsaw	C50/27	11"	.0450" / 1.14mm
43 - 17489	13" Vesco curved handsaw	C50/32	13"	.0490" / 1.24mm

Vesco curved handsaw. The pull-stroke pruning saw ensures a clean and precise cut. The blade has a three-sided cutting edge and tempered teeth. The blade also includes a smooth side surface that improves the performance during cutting helping to avoid infections and ensures healing of the plant. Comes with a plastic sheath that has a flat rotating belt-loop.

**NEW**

## Handsaw from SUGOI



Rotary #	Description	OEM	Size	Thickness
43 - 17730	Silky SUGOI 360mm Blade with Scabbard	390-36	14"	.0715" / 1.80mm
43 - 17762	Replacement blade for our Sugoi Professional 360mm Saw 43-17730.	391-36	14"	.0715" / 1.80mm



43-17730



43-17762

The Silky Sugoi 360 saw and scabbard is a popular, best-selling, professional hand saw with a taper-ground curved blade with an exceptional design for greater cutting speed. With a mono-constructed, 14 inch razor sharp blade with super aggressive tooth pattern, Silky has designed a high performance blade for smooth cutting with less effort.

## Ultimate Professional Handsaws from ZUBAT



Rotary #	Description	OEM	Size	Thickness
43 - 17736	ZUBAT ULTIMATE PROFESSIONAL 330mm	746-33	13"	.0665" / 1.67mm
43 - 17737	Replacement blade for our Zubat Ultimate Professional 330mm saw 43-17736.	747-33	13"	.0665" / 1.67mm



43-17736



43-17737

A new and improved ZUBAT - the favorite handsaw of the professional tree care industry. This version has finer teeth near the handle for an easier start to your cut, and new GOKAI-ME teeth to better remove sawdust from the cut.

## Ultimate Professional Handsaws from ZUBAT



Rotary #	Description	OEM	Size	Thickness
43 - 17761	ZUBAT Professional 330mm	270-33	13"	0.055" / 1.4mm
43 - 17729	Replacement blade for our Zubat Professional 330mm saw 43-17761	271-33	13"	0.055" / 1.40mm



43-17761



43-17729

The Silky Zubat professional handsaw is without question the most popular handsaw in the tree care industry. Featuring a comfortable and ergonomic handle and a full tang 330mm curved blade. The scabbard is outfitted with an efficient roller system to make taking the saw in and out easy, and a locking system that will keep the saw in its place, even when inverted.

## Curve Professional 300mm Blade from GUNFIGHTER



43-17734



43-17735



Rotary #	Description	OEM	Size	Thickness
43 - 17734	Curve Professional 300mm Blade and Scabbard.	730-30	11.80"	.050" / 1.27mm
43 - 17735	Replacement blade for our Gunfighter Curve Professional 300mm saw 43-17734.	731-30	11.80"	.050" / 1.27mm

The Silky GunFighter is one of the best new saw and scabbard on the market. The blade is not a full tang, but is toolless - just lift up on the "trigger" at the top of the handle to release the blade and slide it out.

## Curved Handsaw from GOMBOY



43-17732



43-17733



Rotary #	Description	OEM	Size	Thickness
43 - 17732	GOMBOY CURVE PROFESSIONAL 240mm	717-24	10.63"	.048" / 1.21mm
43 - 17733	Replacement blade for our Gomboy Curve Professional 240mm saw 43-17732.	718-24	10.63"	.048" / 1.21mm

This Silky Gomboy folding saw w/ case blows other folding saws out of the water due to its curved blade and amazing speed. Featuring multiple blade-locking angles for flush cutting, this lightweight folding saw features very smooth cutting action even as the aggressive teeth cut green or dry wood.

**NEW**

## BL Hollow Core Poles from JAMESON



43-17611

This super lightweight pole provides less flex for greater control when connecting two or even three poles. Aircraft grade male and female aluminum ferrules.

Not a "Hot Stick" - Not for use on energized lines.  
Made in the USA.



Rotary #	Pole Type	OEM	Length	Wall Thickness	Pole Dia.	Weight	Color
43 - 17609	EXTENSION	BL-6	6'	0.75"	1.25"	1.6 lbs	Blue
43 - 17610	BASE	BL-6F	6'	0.75"	1.25"	1.6 lbs	Blue
43 - 17611	SAW HEAD POLE USES OUR 43-17609, 43-17610	BL-6SFP	6'	0.75"	1.25"	1.6 lbs	Blue

This product is not REACH compliant and cannot be sold outside the USA.



43-17609



43-17610

## Barracuda Telescoping Pole Saw from JAMESON



43-17764

Rotary #	Pole Type	OEM	Length	Color
43 - 17764	TELESCOPING POLE	TP-6AL-FS	3.4' - 5.6' 41" - 68"	Aluminum



The Jameson Barracuda Telescoping Pole Saw is designed to provide you with unmatched cutting reach, extending effortlessly from 41 inches to 68 inches. This versatility allows you to trim branches and prune high foliage without the need for a ladder. Despite its impressive capabilities, it weighs just 1.4 pounds, making it a breeze to handle. This lightweight powerhouse is perfect for both professionals and DIY enthusiasts, as its design reduces fatigue, allowing you to work longer with ease.

## Telescoping Poles from JAMESON



43-17539

Rotary #	Pole Type	OEM	Length	Color
43 - 17539	TELESCOPING POLE	TP-6F	4' - 6' 48" - 72"	Yellow



The Jameson TP-6F Telescoping Poles are constructed from lightweight fiberglass and offer a space-saving design. The double lock system keeps the telescoping pole from collapsing and gives you a secure connection, no matter what the length. The pole length extended from 4' - 6' with a female ferrule to easily switch from pruner to saw with the same pole. For maximum safety, do not use extension poles or Tru shot.

## Folding Pole Saw Head from JAMESON

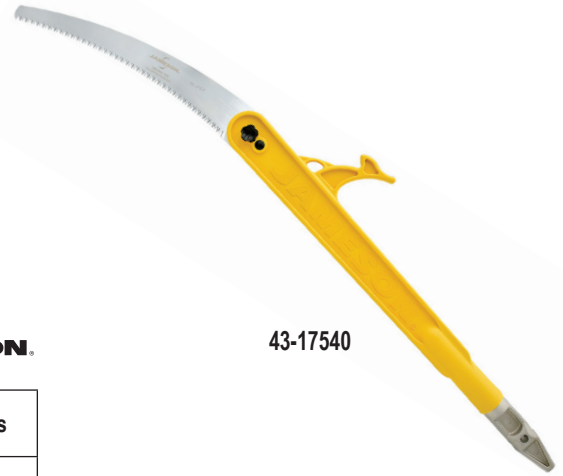
**43-17540**

Rotary #	Description	OEM	Length	Thickness
<b>43 - 17540</b>	FOLDING POLE SAW	PS-4FS	13"	.065" / 1.65mm

Folding Pole Saw combines safety and convenience with its foldable design, lightweight construction, and easy tool installation. Its high-visibility yellow finish prevents tool loss and serves as a handsaw. Paired with the Barracuda™ Tri-Cut Saw Blade, the 13" hard-chrome plated blade ensures cleaner, quicker cuts and extended durability. This Dynamic Duo enhances efficiency and safety for arborists and homeowners alike.

## Folding Pole Saw Replacement Blade from JAMESON

**43-17541**

Rotary #	Description	OEM	Length	Thickness
<b>43 - 17541</b>	REPLACEMENT BLADE	SB-13TE-F	13"	.065" / 1.65mm

The Barracuda™ Tri-Cut Saw replacement Blade is 13" hard-chrome plated blade that ensures cleaner, quicker cuts and extended durability. This Dynamic Duo enhances efficiency and safety for arborists and homeowners alike. This blade fits the Folding Pole Saw Head Part Number PS-4FS, our part number **43-17540**.

## Launch Head Only from JAMESON



Rotary #	Pole Type	OEM
<b>43 - 17608</b>	BIG SHOT LAUNCH HEAD ONLY	BS-1

The Big Shot launch head only. Delivering line up to 150'. Recommended to be used with two 4' poles or one 4' pole and one 6' base pole. Not for use with telescoping poles. Includes steel head, elastic tubing and yellow pouch (poles not included).

**NEW**

## Straight Blade Hedge Shears from VESCO

The S1/75 Vesco Straight blade hedge shears are made with tempered carbon steel blades. The tool also has a shock-absorber and cushion. The handles are made of alloy aluminum with EUROGRIP, ergonomic and non slip in bi-component material.



Rotary #	Pole Type	OEM
43 - 17486	30" Straight Blade Hedge Shears	S1 / 75



## Wavy Blade Hedge Shears from VESCO

The S2/75 Vesco wavy blade hedge shears are made with tempered carbon steel blades. The wavy conformation of the blades allows to better hold branches cutting operations. The tool also has a shock-absorber and cushion. The handles are made of alloy aluminum with EUROGRIP, ergonomic and non slip in bi-component material.



Rotary #	Pole Type	OEM
43 - 17487	30" Wavy Blade Hedge Shears	S2 / 75



## Heavy Duty Bypass Loppers from JAMESON

Professional grade, designed and built with the user in mind. Highest quality materials and workmanship provide precise cuts, ease of use, and long lasting cutting performance with 1-3/4" cutting capacity. This product is not REACH compliant and cannot be sold outside the USA.



Rotary #	Pole Type	OEM
43 - 17706	Heavy Duty 29" Bypass Loppers	HL-BP201



## Groundskeeper II Rake

The Groundskeeper II Rake is lightweight and extremely durable. It is far less cumbersome than most other rakes on the market today. With the fiberglass handle and no break co-polymer head it makes this rake almost impossible to destroy. The rake requires no down pressure and is easy on your back.  
MIN010.



Rotary #	Description	OEM
 43 - 17708	Groundskeeper II Rake	32230-IS10

## Tazzy Log Roller

The Tazzy Log Roller is a heavy duty log roller / lifter. It has a removable handle for easy storage. The 63" handle allows for great leverage for lifting logs from 10" to 40" in circumference. Solid steel construction.



Rotary #	Pole Type	OEM
 43 - 17554	Tazzy Log Roller	A1753

# Index

**A**

**AIR FILTERS (By OEM)**

Enginaire ..... 11

Kohler ..... 11

Toro ..... 11

**ARBORIST / ACCESSORIES** ..... 21-37

**B**

**Bags**

Notch ..... 29

Rotary ..... 29

**BEARINGS (By OEM)**

Blue Bird ..... 3

Exmark ..... 3

Husqvarna ..... 3

Hustler ..... 3

MTD ..... 3

Scag ..... 3

Snapper ..... 3

Toro ..... 3,4

**BELTS (By OEM)**

ARIENS ..... 8

GRAVELY ..... 8

HUSQVARNA ..... 8

SCAG ..... 8

SNAPPER ..... 8

TORO ..... 8

WALKER ..... 8

**BLADES (by OEM)**

BAD BOY ..... 9

DAYE / HYPER TOUGH ..... 9

EGO ..... 9

EXMARK ..... 9,10

FERRIS ..... 10

KUBOTA ..... 10

MTD ..... 10

SPARTAN ..... 10

TORO ..... 11

**C**

Carburetor Kit ..... 13,14

**CARBURETORS (By OEM)**

Briggs & Stratton ..... 12,13

Kawasaki ..... 13

Kohler ..... 13

STIHL ..... 13

Carlisle Tires ..... 2

Caster Yoke ..... 4

**Castrol**

10W-40 Oil ..... 17

20W-50 Hydro-Transmission Fluid ..... 17

20W-50 Oil ..... 17

**Chainsaw Rim Sprockets**

Harvester Rim Sprockets ..... 19

Climbing Kit ..... 29

Communication Helmet Kits ..... 27

Compression Release ..... 20

**D**

Diaphragms ..... 14

**E**

Edger Blades ..... 11

**ELECTRIC PTO CLUTCHES (By OEM)**

ARIENS ..... 6

CASTELGARDEN ..... 6

CUB CADET ..... 6

EXMARK ..... 6,7

GRAVELY ..... 7

HUSTLER ..... 7

JOHN DEERE ..... 7

MTD ..... 7

WRIGHT STANDARD ..... 7

**EQUIPMENT BAGS**

**Notch**

Hauler 70L Bag ..... 29

Rotary Duffle Bag ..... 29

**F**

Fuel Hose Connector ..... 19

Fuel Hose Grommet ..... 20

Fuel Module Assembly ..... 14

Funnel Set ..... 15

**G**

Galaxy Mighty Mow Tires ..... 2

**GASKET SETS (By OEM)**

Stihl ..... 20

**GEAR**

**Notch**

Acculine Throwline ..... 26

Catalyst Harness ..... 28

Ergo Tree Gaffs ..... 28

Flipline Glide Rope Grab ..... 23

Hauler 70L Bag ..... 29

Lanyard Glide Rope Grab ..... 23

Nylon Loop Runner ..... 26

Quick Cinch Chainsaw Lanyard ..... 24

Rigging Blocks ..... 25

Rigging Block with Ultra Sling ..... 24

Rope Runner Vertec ..... 25

Speed Line Kit ..... 25

Stainless Steel Portawrap ..... 24

Throw Line Kit ..... 29

Throw Weight Bags ..... 26

**Protos**

Arborist Helmets ..... 27

Helmets with Communication Systems ..... 27

**Sena**

Communication Kits

33I+ Comm System ..... 27

Universal Clamp Kit ..... 27

Work 4 Pro Bulk Pack ..... 27

**Silky**

Handsaw ..... 32,33

**Stein**

Skyshot Pro Throwbags ..... 26

# Index

<b>G (cont.)</b>		<b>N</b>	
<b>GEAR (cont.)</b>		<b>Notch</b>	
<b>Teufelberger</b>		Acculine Throwline.....	26
PulleySaver.....	24	Catalyst Harness.....	28
TreeMotion Harness Pro.....	28	Ergo Tree Gaffs.....	28
<b>US Rigging</b>		Glide Rope Grab Flipline.....	23
Chainsaw Lanyard.....	25	Glide Rope Grab Lanyard.....	23
<b>Vesco</b>		Hauler 70L Bag.....	29
Curved Handsaw.....	31	Nylong Loop Runner.....	26
Folding Handsaw.....	31	Quick Cinch Chainsaw Lanyard.....	24
Multi Purpose Sheath.....	30	Rigging Block.....	25
Pruning Shears.....	30	Rigging Block with Ultra Sling.....	24
Sharpening Stones.....	30	Rope Runner Vertec.....	25
<b>GRASS BAG (By OEM)</b>		Speed Line Kit.....	25
Exmark.....	14	Stainless Steel Portawrap Whoopie Sling..	24
Scag.....	14	Throw Line Kit.....	29
Groundskeeper II Rake.....	37	Throw Weight Bags.....	26
		X-Ring Rigging Sling.....	23
	<b>H</b>		<b>O</b>
<b>Harvester Saw Chain</b>		<b>Oil</b>	
Cut Loops.....	18	10W-40 Oil.....	17
<b>Helix</b>		20W-50 Oil.....	17
Double Wire Hose Clamps.....	12	Oil Filters.....	11
Foot Actuated Air Pump.....	16	OO Grease.....	16
Heavy Duty Spring Pull Tool.....	16		
Metric Allen Wrench Set.....	16		<b>P</b>
Safety Wire.....	16	Pneumatic Tires.....	2
Super Duty Cable Ties.....	16	Poly-V Belt Drive.....	20
Valve Stem Tool.....	16	<b>Protos</b>	
Wire Loom.....	16	Helmets.....	27
High Back Seats.....	12	Helmets with Communication.....	27
Hitch Climber Pulley Kit.....	24	<b>Pulleys</b>	
Hose Clamps.....	12	V-Idler.....	8
Hydro Oil Filter.....	11	<b>PULLEYS (By OEM)</b>	
		HUSQVARNA.....	9
		MTD/CUD CADET.....	9
	<b>I</b>		
<b>IGNITION COILS (By OEM)</b>			<b>R</b>
Briggs & Stratton.....	15	Rakes.....	37
Kawasaki.....	15	Harvester Chain Saw Rim Sprockets.....	19
Kohler.....	15	<b>ROPE (By OEM)</b>	
Intake Manifolds.....	19	<b>Rope Logic</b>	
		Whoopie Sling.....	23
	<b>J</b>	<b>Notch</b>	
<b>Jameson</b>		Rigging Block with Ultra Sling.....	24
BL Hollow Core Poles.....	34	X-Ring Rigging.....	23
Folding Pole Saw Head.....	35	<b>Samson</b>	
Folding Pole Saw Replacement Blade.....	35	Danube Climbing.....	21
Launch Head only.....	35	Stable Double Briad Rigging.....	22
Telescoping Poles.....	34	True-Blue Braided.....	21
		<b>Sterling</b>	
	<b>K</b>	Kraken Rigging.....	22
Kenda Tires.....	2	<b>Teufelberger</b>	
		Drenaline Climbing.....	21
	<b>L</b>		
Log Roller.....	37		
	<b>M</b>		
Mist-Pro Blower/Fogger Kit.....	18		
Molded Fuel Line.....	19		

# Index

**R (cont.)**

**ROPE ASSEMBLIES**

**Notch**

Glide Rope Grab Flipline .....23  
 Glide Rope Grab Lanyard .....23  
 Speed Line Kit .....25  
 Stainless Steel Portawrap .....24  
 Rigging Block with Ultra Sling .....24  
 X-Ring Rigging Sling .....23

**Teufelberger**

Pulley Saver .....24

Rotary Saw Chain Cut Loops .....18

**S**

**Samson**

Danube Climbing .....21  
 Double Braid Rigging Rope .....22  
 True-Blue Braided Climbing .....21

**SPARK PLUGS (BY OEM)**

NGK .....14

**SPINDLE ASSEMBLY (BY OEM)**

CUB CADET .....5  
 HUSTLER .....5  
 JOHN DEERE .....5,6

Springs .....4,5

Stator Regulator .....15

**Sterling**

Kraken Rigging .....22

**T**

Tazzy Log Roller .....37

**Teufelberger**

Drenaline Climbing .....21  
 Pulley Saver .....24  
 TreeMotion Harness Pro .....28

**THROW BAGS**

**Notch**

Throw Weight Bags .....26

**Stein**

Skyshot Pro Throwbag .....26

Transmission Fluid

20W-50 .....17

**TREE TRIMMING**

**Jameson**

BL Hollow Core Poles .....34  
 Folding Pole Saw Blade .....35  
 Folding Pole Saw Head .....35  
 Hand Lopper .....36  
 Launch heads .....35  
 Telescoping Poles .....34

**Silky**

Gomboy .....33  
 Gunfighter .....33  
 Sugoï .....32  
 Zubat .....32

**T (cont.)**

**TREE TRIMMING (cont.)**

**Vesco**

Curved handsaw .....31  
 Folding handsawm .....31  
 Hedge Shears .....36  
 Multi Purpose Sheath .....30  
 Pruning Shears .....30  
 Sharpening Stones .....30

**TUBES**

Cheng Shin .....2

**U**

**US Rigging**

Chainsaw Lanyard .....25

**V**

**Vesco**

Curved Handsaw .....31  
 Folding Handsaw .....31  
 Hedge Shears .....36  
 Multi Purpose Sheath .....30  
 Pruning Shears .....30  
 Sharpening Stones .....30

**VOLTAGE REGULATOR (BY OEM)**

Kawasaki .....15

**VP FUELS**

5.5 Gallon Motorsport Container .....17  
 Jug Cap .....17  
 Jug Vent Cap .....17  
 O-Ring .....17



AMERICA'S #1 SUPPLIER

Now Offering  
Full Line of  
Arborist Equipment,  
Gear & Supplies.



**MORE PARTS. MORE VALUE.  
EXCEPTIONAL SERVICE!**

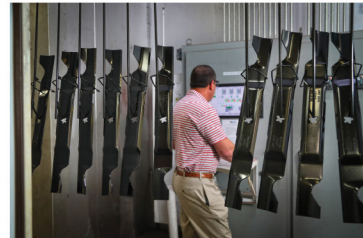

Filters, blades and trimmer line are  
proudly made in the USA by Rotary.



**NEXT DAY DELIVERY TO 80% OF THE USA!**