



Luxurious Course
Furnishings and Accessories

CATALOG





In 2026, JFM Golf is proud to celebrate our 25th anniversary serving the golf industry. From our humble beginnings in a family garage, we have grown into a trusted partner for golf courses and country clubs across the country. We extend our sincere thanks to our loyal customers and distributors whose support has fueled our journey and affirmed our passion for excellence.

Throughout our evolution, one principle has never changed: an unwavering commitment to quality. By investing in state of the art manufacturing technology and advanced materials, we continue to lead the industry with premium golf course supplies and accessories. Every product we create is designed and manufactured in the USA and backed by our industry leading one year Total Satisfaction Guarantee.

Through the years, we have continued to expand our product line, introducing new offerings that meet the evolving needs of our customers. With new products added daily to our website, we make it easier than ever to find exactly what you need. To respect your time, you can browse and order online anytime, at your convenience. No matter the role you play, whether you are a golf course superintendent, head golf professional, general manager, or director of golf we carry the products for every job on the course, and we have you covered.

Our just in time manufacturing process reflects both efficiency and responsibility, delivering cost-effective solutions while reducing waste. This commitment to sustainability allows us to provide eco-friendly products that withstand the test of time products that your members and maintenance teams can rely on season after season.

At JFM Golf, our name represents both a proud legacy and a future-focused vision. As your one stop shop for golf course essentials and premium accessories, we are honored to serve the needs of clubs and communities, helping you elevate the experience of the game for every golfer.

At JFM Golf, one call gets it all.

Proud Member of the



Proud Supporter



Proud Supporter



Plastic Products Made with 100% Recycled Plastic



MADE IN THE U.S.A.



Our Newest Product Collection



Introducing the JF Manufacturing Tribute Collection: Honoring Roby's Legacy

At JF Manufacturing, we are more than just a company we are a family. And sometimes, family members come in all shapes and sizes, including four-legged ones. Today, we are both proud and emotional to introduce our Tribute Collection, a special series dedicated to our beloved dog, Roby.

Roby: A True Family Member

Roby was more than just a pet to us. He was an integral part of the JF Manufacturing team, a constant presence that brought joy, comfort, and a sense of community. His gentle nature and unwavering loyalty made him not only a cherished member of our family but also a friend to everyone who crossed paths with him. Whether he was accompanying us to the office or offering a comforting presence during long work hours, Roby's spirit was a source of light and love.

Giving Back: A Meaningful Cause

In memory of Roby and the impact he had on our lives, we are dedicating a portion of the proceeds from every sale of the Tribute Collection to the Warrior Dog Foundation. This incredible organization supports retired military and working dogs—heroes who have served alongside our soldiers and first responders, providing protection, companionship, and invaluable service. We believe that dogs play a vital role not only in our personal lives but also in the lives of those who serve. They are protectors, companions, and unsung heroes. Roby's story and legacy inspire us to give back to those who continue to protect us in their own special way.

What's Included in the Collection The Tribute Collection is a carefully curated selection of products that reflect the heart and soul of our team and the love we had for Roby. Each item in the collection is crafted with care and attention to detail, representing the dedication and spirit that Roby brought to everything he did. With every purchase, you're not just getting a piece of our collection—you're helping to support dogs in need. Your contribution will help the Warrior Dog Foundation continue their vital work, ensuring that retired service dogs receive the care, training, and love they deserve after their years of loyal service.

Thank You for Joining Us in This Tribute

We are deeply grateful to have had Roby by our side, and while his presence is no longer with us physically, his legacy will continue to live on through this collection. Your support means the world to us, and we are honored to have you join us in giving back to the incredible dogs who make a difference every day. Thank you for being part of this journey. Together, we can honor Roby's memory and help support those who have served alongside our heroes.





















































At J.F. Manufacturing, Inc. our mission is to provide you with the highest quality products at the best possible prices. We use only the finest materials when it comes to making our products. We strive to go above and beyond when it comes to quality. Because we manufacture all our own recycled plastic products, we are able to sell direct to the customer saving you money. We also have a complete sign and flag shop on site. With over 25 years in the golf industry, you can be sure you are receiving quality products. If you are looking for something you don't see in our catalog, give us a call as we can probably make it for you.

Golf Accessory Categories

Signs	PG. 10-57
Range/Practice Area	PG. 46-75
Clubhouse/Tournament	PG. 76-89
Casual Furniture	PG. 90-97
Waste & Recycle Enclosures	PG. 98-107
Tee Area	PG. 108-135
Fairway	PG. 136-141
Flags	PG. 142-151
Greens & Grounds	PG. 152-157
Maintenance	PG. 158-189

	10 - 27	Engraved Laminated Directional Signs		92 - 93	Chairs & Picnic Tables
	28 - 29	Custom Signs		94 - 97	Dining & Lounge Seating
	30 - 31	Custom Aluminum Fairway Signs		98 - 103	Waste Enclosures
	32 - 33	Custom Engraved Signs		104 - 105	Recycle Enclosures
	34 - 35	Custom Course Entrance & Stop Signs		106 - 107	Towel Station Enclosures
	36 - 45	Bronze & Aluminum Signs		108 - 113	Divot Mix Containers
	46 - 47	Yardage Easels		114 - 115	Bottle Racks & Bottles
	48 - 49	Custom Directional Clock Easels		116 - 117	Ball Washers
	50 - 51	Clock Stands & Signage		118 - 121	Tee Markers
	52 - 53	Range & Tee Signs		122 - 135	Water Coolers
	54 - 55	Tee Signs		126 - 129	Beverage Stations
	56 - 57	Custom Range Signs		136 - 140	Stakes
	58 - 61	Golf Range Targets		141	Yardage Markers
	62 - 63	Range Dividers & Ball Crates		142 - 151	Flags
	64 - 67	Bag Stands		152 - 153	Flagsticks
	68 - 69	Club Washers		154 - 157	Greens
	70 - 71	Pickers/Parts & Accessories		158 - 159	Maintenance Supplies
	72 - 73	Ball Baskets & Stackers		160 - 161	Drag Mats & Bunker Rakes
	74 - 75	Range Mats & Targets		162 - 165	Tools
	76 - 79	Bag Racks		166 - 173	Irrigation
	80 - 83	Podiums		174 - 175	Hoses
	84 - 85	Scorecard Caddies		176 - 177	Rustoleum Paint
	86 - 87	Shoe Cleaner Stations		178 - 179	Accuproducts
	88	Logo Branded Golf Items		180 - 185	Golfco Rollers
	89	Score Boards		186 - 189	Turf Pride
	90 - 91	Benches			



TANGENT[®]

SUSTAINABLE LUMBER



JF Manufacturing has proudly used Tangent Recycled Plastic Lumber for over 25 years because it is of the highest quality and has the widest color selections available. Our furnishings are high end because we use high end materials.

1. Environmental Sustainability:

- Reduces Landfill Waste: This is arguably the biggest benefit. By transforming post-consumer and post-industrial plastic waste (like milk jugs, detergent bottles, and other HDPE plastics) into durable products, we divert millions of pounds of plastic from landfills and oceans.

2. Exceptional Durability and Longevity:

- Weather Resistance: Recycled plastic HDPE is incredibly resilient to all types of weather. It will not rot, rust, splinter, or corrode, making it ideal for outdoor use in any climate.
- UV Resistance: Quality recycled plastic furniture is treated with UV inhibitors, preventing it from fading, cracking, or becoming brittle due to prolonged sun exposure. This means colors stay vibrant for years.
- Moisture and Insect Proof: Unlike wood, recycled plastic does not absorb moisture, so it is immune to mold, mildew, rot, and insect infestations.

3. Low Maintenance:

- Easy to Clean: The nonporous surface of recycled plastic makes it incredibly easy to clean. A simple wipe down with soap and water is usually all that is needed to keep it looking new.
- No Painting, Staining, or Sealing: Unlike wood, it never needs painting, staining, or sealing, eliminating ongoing maintenance costs and effort.
- Resistant to Stains and Spills: Its nonporous nature also means it resists stains and spills, making it the perfect option for busy environments or outdoor entertainment.
- In summary, choosing recycled plastic furnishings is a powerful way to make an environmentally responsible choice without compromising on durability, aesthetics, or functionality.

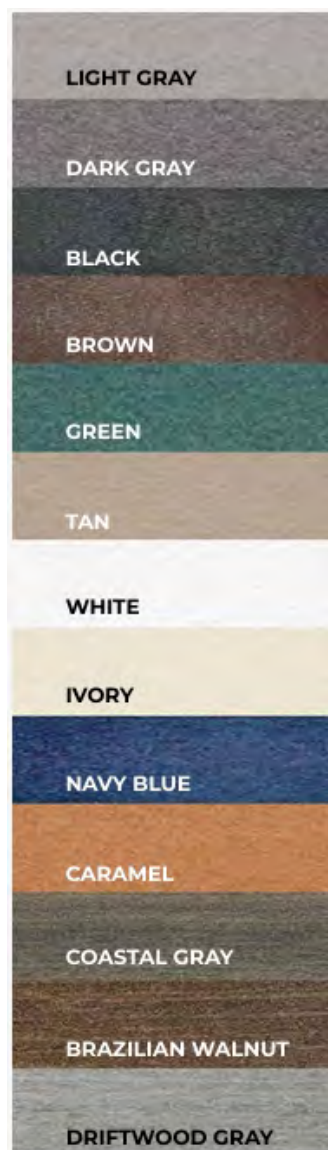

KING King Plastic Corporation

JF Manufacturing proudly uses King Plastic Corporation's HDPE (High-Density Polyethylene) laminate plastic as it has been proven to be the highest quality material since 1968 and the brand is synonymous with quality to those who know plastics.

Exceptional Durability and Longevity:

- Weather Resistance: HDPE is inherently resistant to a wide range of weather conditions making it suitable for all climates. It does not rot, rust, or corrode, and it performs well in both hot and cold temperatures.
- UV Stabilization: Many HDPE laminates are specifically treated with UV stabilizers. This prevents the material from degrading, fading, or becoming brittle due to prolonged exposure to sunlight, ensuring the sign's colors and integrity last for years.
- UV Stabilization: Many HDPE laminates are specifically treated with UV stabilizers. This prevents the material from degrading, fading, or becoming brittle due to prolonged exposure to sunlight, ensuring the sign's colors and integrity last for years.
- Moisture Resistance: HDPE is waterproof and has extremely low moisture absorption. This prevents issues like mold, mildew, and warping, which can plague other materials like wood or lower grade plastics.

Low Maintenance:

- Easy to Clean: HDPE's nonporous surface makes it easy to clean. Dirt and grime can be easily wiped off which reduces the need for frequent maintenance or replacement.
- No Painting or Sealing: Unlike wood signs that require painting or sealing to protect against the elements, HDPE signs come in a range of colors that are "fused" into the material, meaning they will not need ongoing painting or staining.

Versatility and Aesthetics:

- Color-Cored Options: Many HDPE sign materials are multilayered with contrasting colors. When routed or engraved, the inner color is exposed, creating a clear and durable design without needing paint. This is excellent for safety signs where clarity is paramount.

Environmental Considerations:

- In summary, HDPE laminate is a fantastic choice for signs because of its rugged durability, resistance to environmental factors, low maintenance requirements, and overall longevity, ensuring that your messages remain clear and visible for an extended period.





SIGNS

PRICE MATCH GUARANTEE *with Any Major Competitor*

Engraved Laminated Directional Signs

S100 Series Fairway Signs

Our laminated plastic signs measure 10"x10" overall with a 10"x5" message area and incorporate multiple layers of contrasting colors for bold looks and enhanced visibility. These signs come in two thicknesses: 1/4" and 1/2". They're virtually maintenance free and will never rot or delaminate, even after sustained exposure to cold or hot environments. They'll handle just about any abuse and are available in a color palette that is virtually limitless. Stock colors are shown to the right, but we can customize any sign to suit your needs and style. Add a touch of elegance with our metallic fill option. [See pages 26-27]

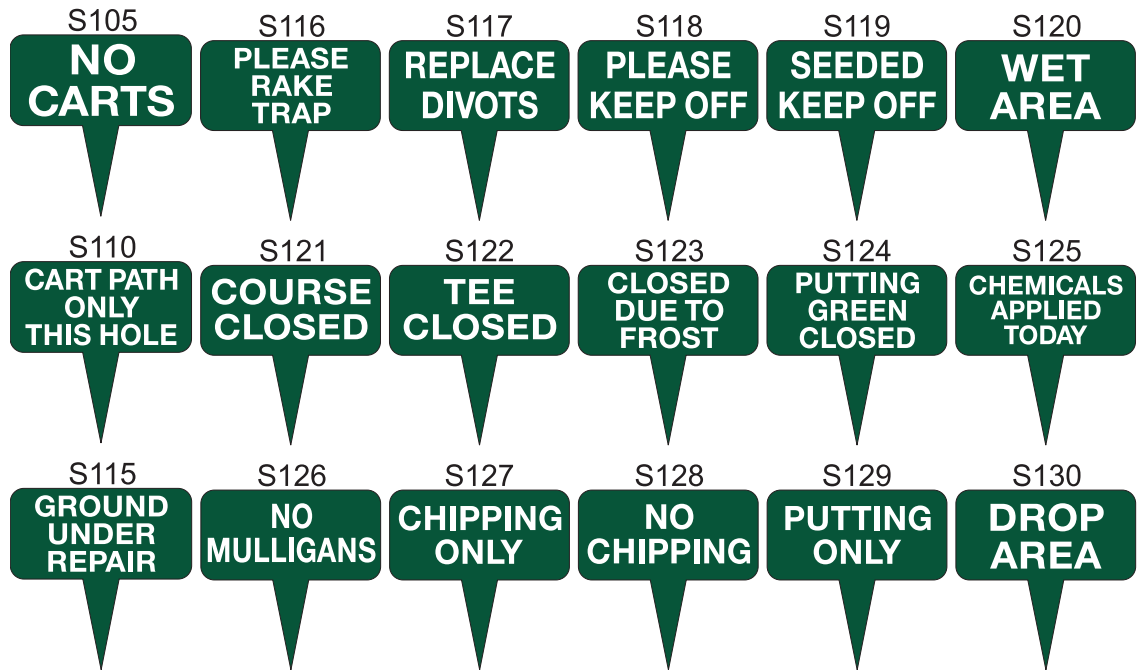
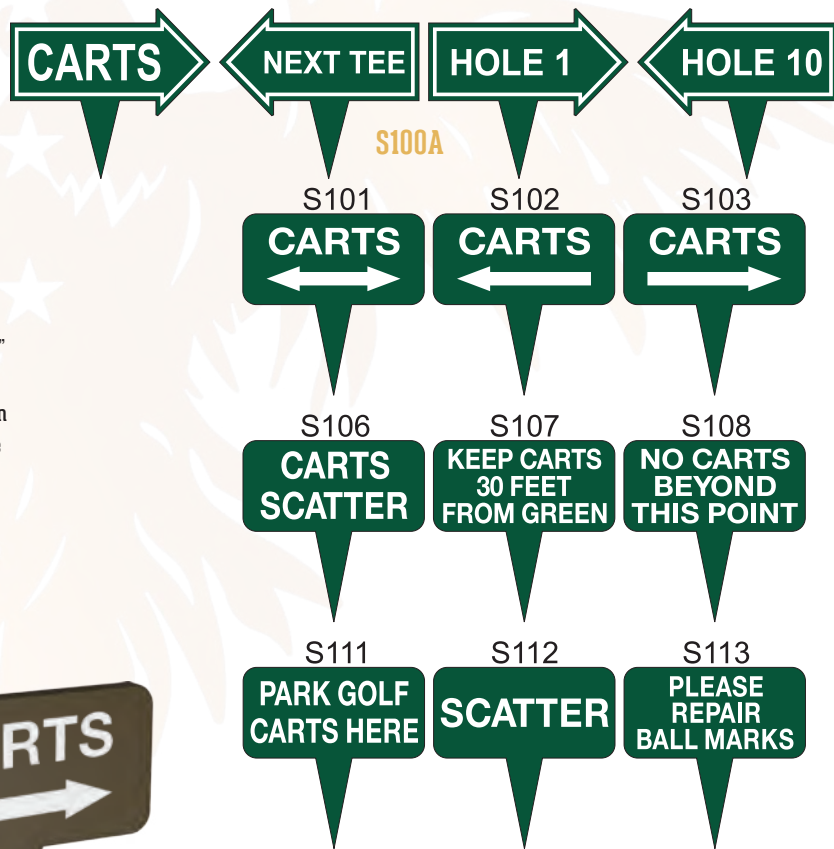

S100C - CUSTOMIZE & ADD YOUR OWN MESSAGE!

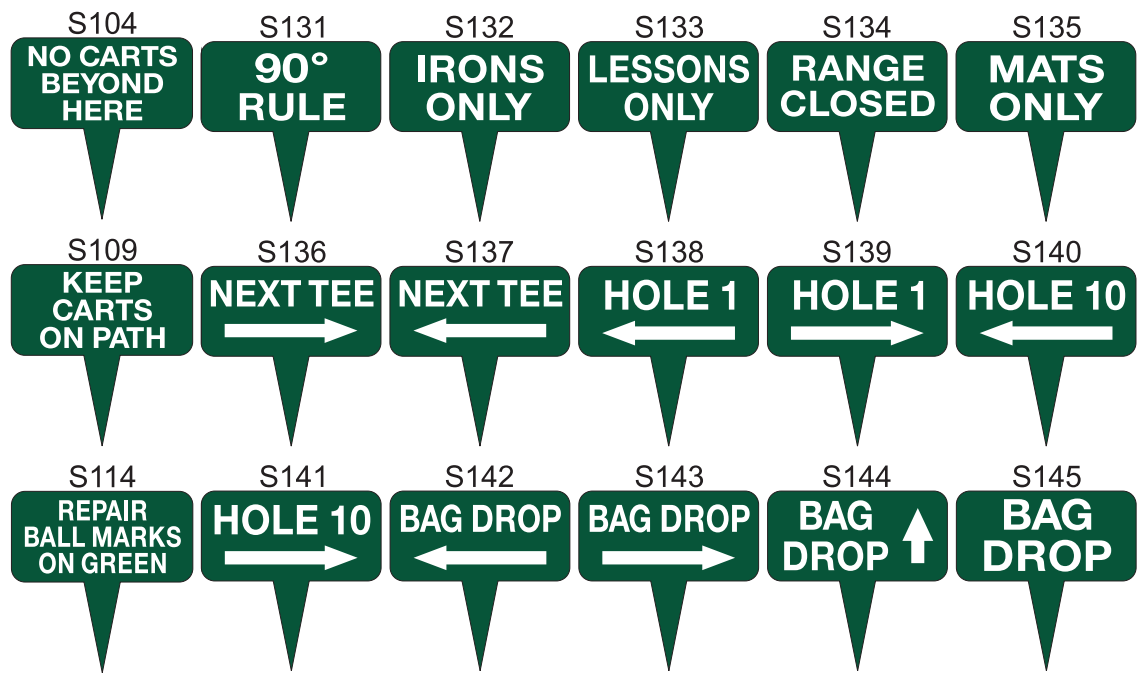

1/2" Thickness Signs		
S100	Single Sided Fairway Sign, 10" x 10" x 1/2"	\$36.75
S100D	Double Sided Fairway Sign, 10" x 10" x 1/2"	\$41.50
S100C	Single Sided Fairway Sign with Custom Message, 10" x 10" x 1/2"	\$36.75
S100CD	Double Sided Fairway Sign with Custom Message, 10" x 10" x 1/2"	\$41.50
S100A	Double Sided Arrow Shaped Sign, 10" x 10" x 1/2"	\$41.50
1/4" Thickness Signs		
S125	Economy Single-Sided Fairway Sign, 10" x 10" x 1/4"	\$18.50
S125D	Economy Double Sided Fairway Sign, 10" x 10" x 1/4"	\$28
S125C	Single Sided Fairway Sign with Custom Message, 10" x 10" x 1/4"	\$18.50
S125CD	Double Sided Fairway Sign with Custom Message, 10" x 10" x 1/4"	\$28
3/4" Thickness Signs		
S100WGF	Single Sided Fairway Sign, Woodgrain Laminate 10" x 10" x 3/4"	\$52.25
S100DWGF	Double Sided Fairway Sign, Woodgrain Laminate 10" x 10" x 3/4"	\$69
S100CWGF	Single Sided with Custom Message Woodgrain Laminate 10" x 10" x 3/4"	\$52.25
S100CDWGF	Double Sided with Custom Message Woodgrain Laminate 10" x 10" x 3/4"	\$69





SIGNS

PRICE MATCH GUARANTEE with Any Major Competitor

Engraved Laminated Directional Signs

S200 Series Directional Signs

Like our S100 Directional Signs, the S200 features bold, easy to read lettering on multiple layers of contrasting colors but incorporates steel spikes that leave a smaller turf imprint and measure 12"x6"x1/2". They're virtually indestructible, but in the event of a mishap, replacement steel spikes are available. Add a touch of elegance with our metallic fill option. [See pages 26-27]

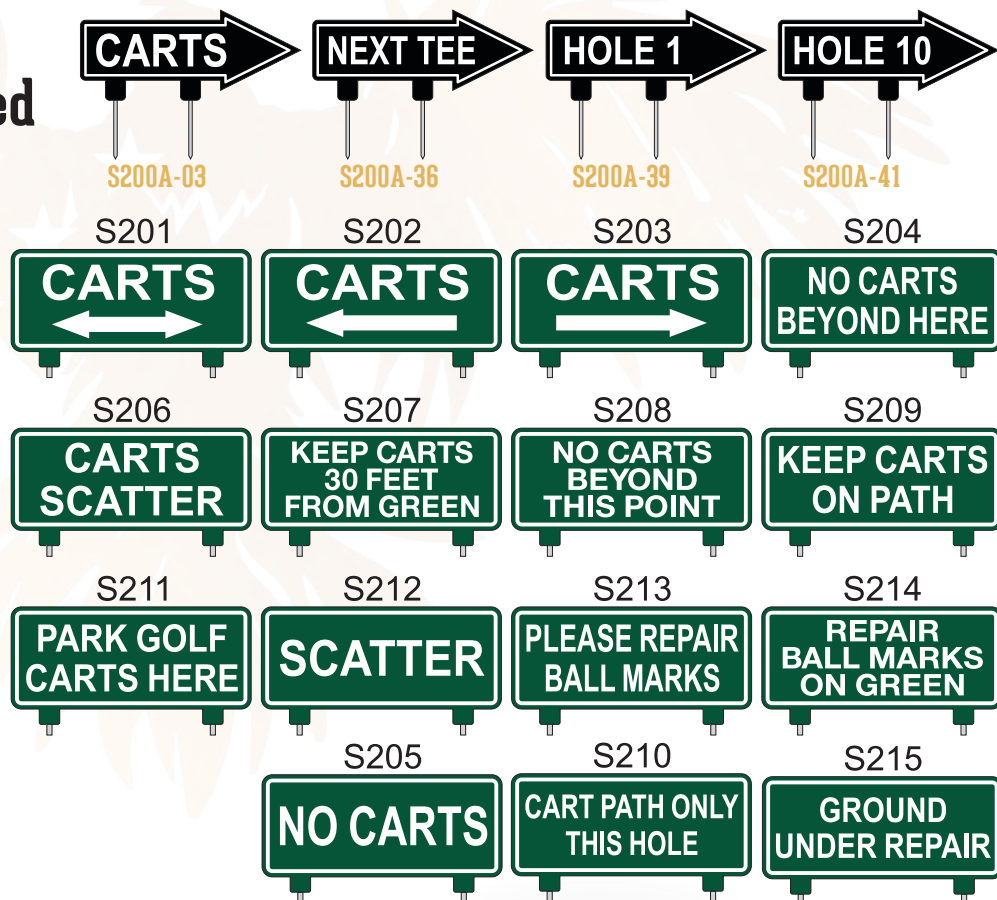

S200	Single Sided Sign w/ 2 steel spikes 12" x 6" x 1/2"	\$40
S200D	Double Sided Sign w/ 2 steel spikes 12" x 6" x 1/2"	\$55
S200C	Single Sided Sign with Custom Message w/ 2 steel spikes, 12" x 6" x 1/2"	\$40
S200A	Double-Sided Arrow Shaped Sign w/ 2 steel spikes, 12" x 6" x 1/2"	\$55
S200PM	Single Sided Post Mount Sign 12" x 6" x 1/2"	\$40
S200CD	Double Sided Sign with Custom Message w/ 2 steel spikes, 12" x 6" x 1/2"	\$55
S200WGF	Single Sided Fairway Sign, Woodgrain Laminate 12" x 6" x 3/4"	\$57
S200DWGF	Double Sided Fairway Sign, Woodgrain Laminate 12" x 6" x 3/4"	\$77
S200CWGF	Single Sided, with Custom Message Woodgrain Laminate 12" x 6" x 3/4"	\$57
S200CDWGF	Double Sided with Custom Message, Woodgrain Laminate 12" x 6" x 3/4"	\$77



SIGNS



S200C - CUSTOMIZE & ADD YOUR OWN MESSAGE!





PRICE MATCH GUARANTEE with Any Major Competitor

Engraved Laminated Directional Signs

S400 Series Directional Signs

If you subscribe to the notion that bigger is better, our S400 Directional Signs are a great choice. They offer the same features and benefits as our S200 Directional Signs, but measure 15" x 9" x 1/2" for enhanced visibility. Easy to install, easy to clean and easy on the eyes. Add a touch of elegance with our metallic fill option. [See pages 26-27]

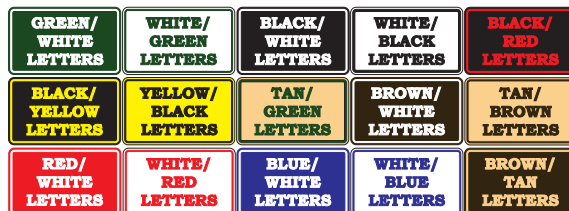
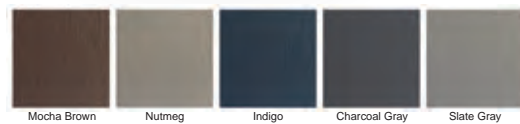

S400	Single Sided w/ 2 steel spikes, 15" x 9" x 1/2"	\$49
S400D	Double Sided w/ 2 steel spikes, 15" x 9" x 1/2"	\$60
S400C	Single Sided with Custom Message w/ 2 steel spikes, 15" x 9" x 1/2"	\$49
S400PM	Post Mount Single Sided Sign 15" x 9" x 1/2"	\$49
S400CD	Double Sided with Custom Message w/ 2 steel spikes, 15" x 9" x 1/2"	\$60
S400WGF	Single Sided Fairway Sign, Woodgrain Laminate 15" x 9" x 3/4"	\$68
S400DWGF	Double Sided Fairway Sign, Woodgrain Laminate 15" x 9" x 3/4"	\$84.25
S400CWGF	Single Sided, with Custom Message Woodgrain Laminate 15" x 9" x 3/4"	\$68
S400CDWGF	Double Sided with Custom Message, Woodgrain Laminate 15" x 9" x 3/4"	\$84.25

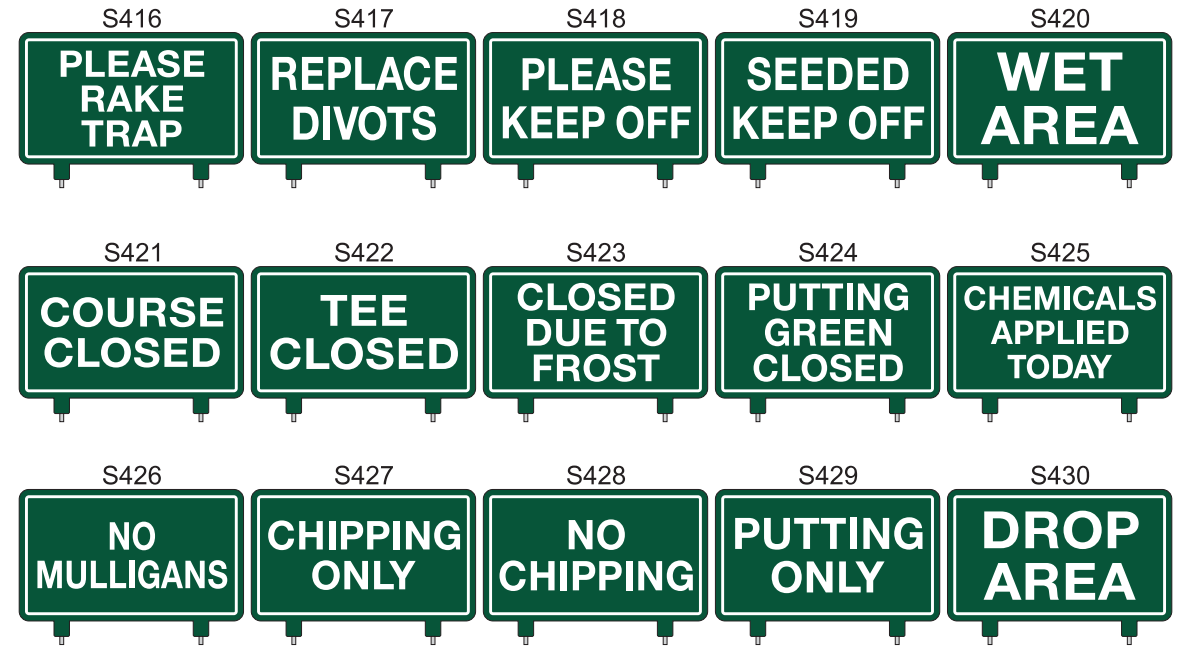

S400C - CUSTOMIZE & ADD YOUR OWN MESSAGE!

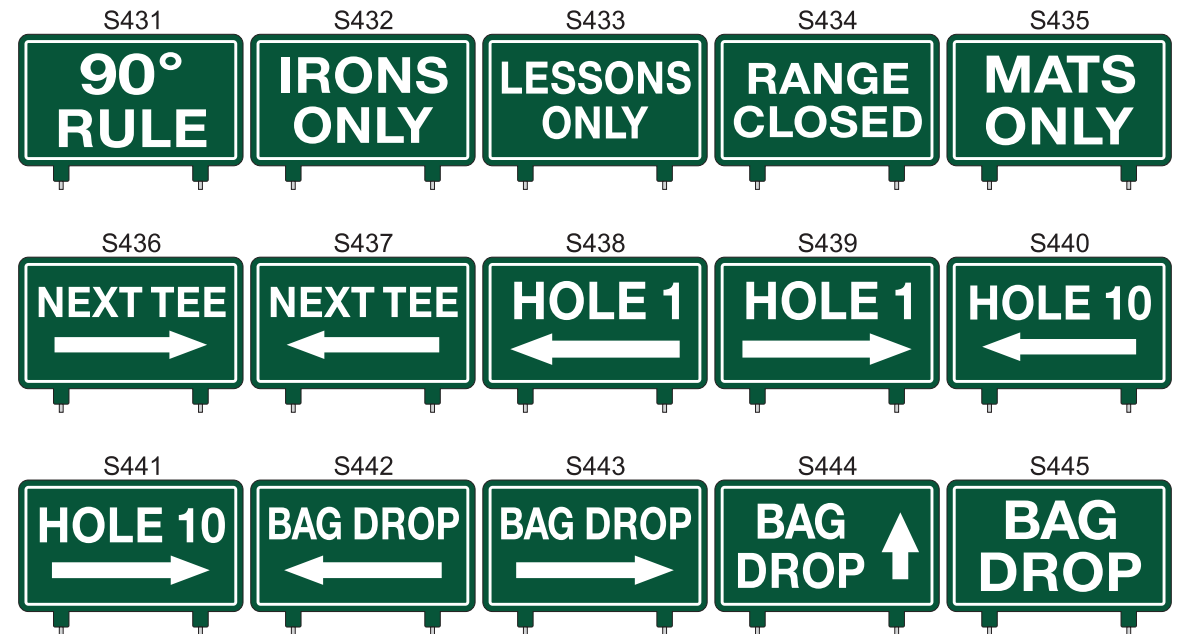



SIGNS

PRICE MATCH GUARANTEE *with Any Major Competitor*

Engraved Laminated Directional Signs

S600 Series Fairway Signs

Offering all the same great features and benefits as our popular S400 series, these signs measure an overall 15" x 14" x 1/2" with a 15"x9" message area for enhanced visibility. They're virtually maintenance free and will never rot or delaminate, even after sustained exposure to cold or hot environments. They are not only easy to install and clean but also easy on the eyes, providing clear and attractive direction for your guests. Add a touch of elegance with our metallic fill option. [See pages 26-27]

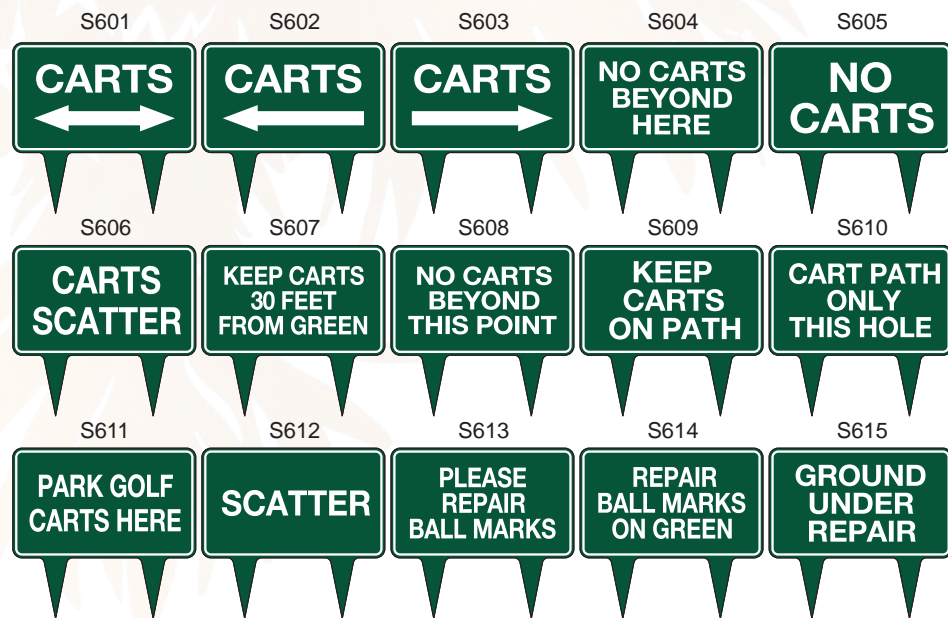

S600	Single Sided w/ 2 plastic spikes, 15" x 14" x 1/2"	\$78
S600D	Double Sided w/ 2 plastic spikes, 15" x 14" x 1/2"	\$98
S600C	Single Sided with Custom Message w/ 2 plastic spikes, 15" x 14" x 1/2"	\$78
S600CD	Double Sided with Custom Message w/ 2 plastic spikes, 15" x 14" x 1/2"	\$98
S600WGF	Single Sided Fairway Sign, Woodgrain Laminate 15"x14"x 3/4"	\$97
S600DWGF	Single Sided Fairway Sign, Woodgrain Laminate 15"x14"x 3/4"	\$122.25
S600CWGF	Single Sided, with Custom Message Woodgrain Laminate 15"x14"x 3/4"	\$97
S600CDWGF	Double Sided Fairway Sign, Woodgrain Laminate 15"x14"x 3/4"	\$122.25



SIGNS



S600C - CUSTOMIZE & ADD YOUR OWN MESSAGE!

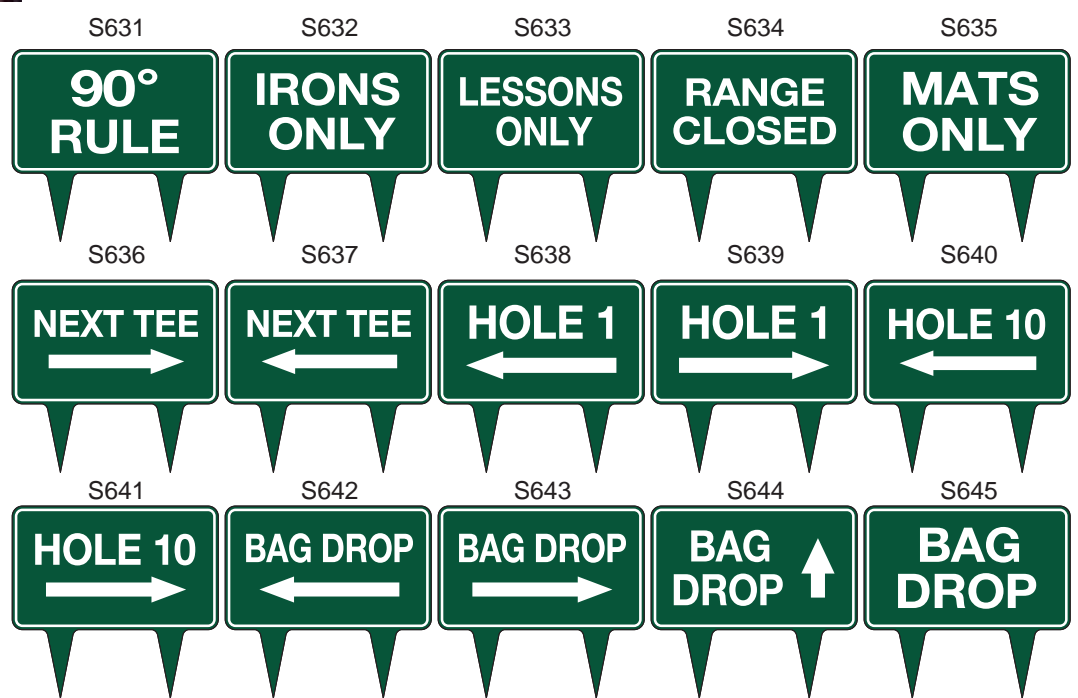



PRICE MATCH GUARANTEE with Any Major Competitor

Engraved Laminated Directional Signs

S700/S725

Ellipse Series Directional Signs

Our S700 and S725 Ellipse Series signs are not only stylish, but with an integrated hand grip, are functional as well. A one hand grab is all that is necessary for relocation or reinstallation, and like our other products, are easy to maintain and look great for years to come. These signs measure 12"x9"x1/2" and are available on single post configuration in 12" and 18" lengths. Add a touch of elegance with our metallic fill option. [See pages 26-27]

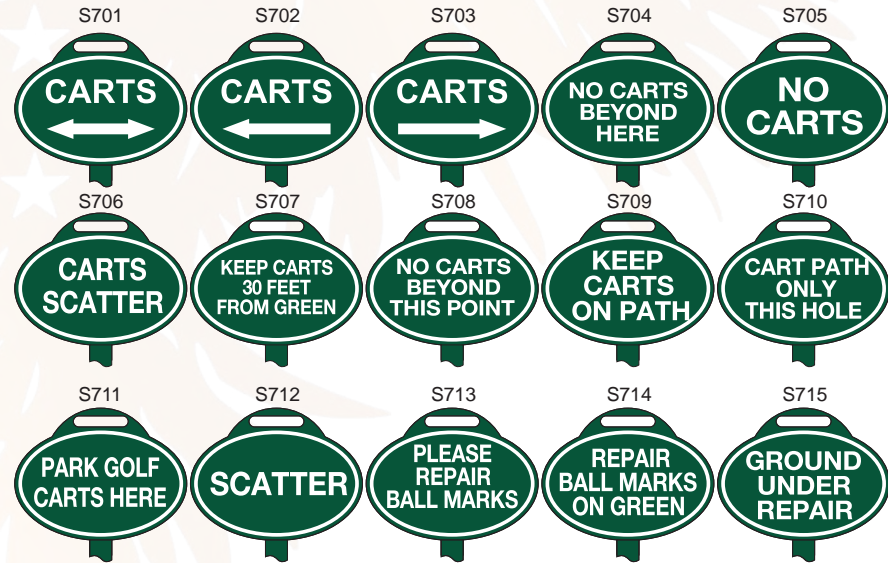

S700	Single sided 12" x 9" x 1/2" on 2"x2"x12" Stake	\$58.50
S700D	Double sided 12" x 9" x 1/2" on 2"x2"x12" Stake	\$73.50
S700C	Single sided 12" x 9" x 1/2" with Custom Message on 2"x2"x12" Stake	\$58.50
S700CD	Double sided 12" x 9" x 1/2" with Custom Message on 2"x2"x12" Stake	\$73.50
S700WGF	Single Sided, Woodgrain Laminate 12"x9"x 3/4" Post Mount on 2"x2"x 12"	\$77.50
S700DWGF	Double Sided Woodgrain Laminate 12"x9"x 3/4" Post Mount on 2"x2"x 12"	\$97.75
S700CWGF	Single Sided Custom Message Woodgrain Laminate 12"x9"x 3/4" Post Mount on 2"x2"x 12"	\$77.50
S700CDWGF	Double Sided Custom Message Woodgrain Laminate 12"x9"x 3/4" Post Mount on 2"x2"x 12"	\$97.75
S725	Single sided 12" x 9" x 1/2" on 2"x2"x18" Stake	\$60
S725D	Double sided 12" x 9" x 1/2" on 2"x2"x18" Stake	\$78
S725C	Single sided 12" x 9" x 1/2" with Custom Message on 2"x2"x18" Stake	\$60
S725CD	Double sided 12" x 9" x 1/2" with Custom Message on 2"x2"x18" Stake	\$78
S725WGF	Single Sided, Woodgrain Laminate 12"x9"x 3/4" Post Mount on 2"x2"x 18"	\$79
S725DWGF	Double Sided Woodgrain Laminate 12"x9"x 3/4" Post Mount on 2"x2"x 18"	\$102.25
S725CWGF	Single Sided Custom Message Woodgrain Laminate 12"x9"x 3/4" Post Mount on 2"x2"x 18"	\$79
S725CDWGF	Double Sided Custom Message Woodgrain Laminate 12"x9"x 3/4" Post Mount on 2"x2"x 18"	\$102.25



S700C - CUSTOMIZE & ADD YOUR OWN MESSAGE!





SIGNS

PRICE MATCH GUARANTEE *with Any Major Competitor*

Engraved Laminated Directional Signs

S750 Ellipse Series Directional Signs

Our S750 Ellipse Series signs are not only stylish, but with an integrated hand grip, are functional as well. A one-hand grab is all that is necessary for relocation or re installation, and like our other products, are easy to maintain and look great for years to come. These signs measure 12"x9"x1/2" and include 2 Steel spikes to push easily into the turf. Add a touch of elegance with our metallic fill option. [See pages 26-27]



S750	Single Sided 12" x 9" x 1/2" and 2 Steel Spikes	\$43
S750D	Double Sided 12" x 9" x 1/2" and 2 Steel Spikes	\$58.50
S750C	Single Sided w/ Custom Message 12"x 9"x 1/2" & 2 Steel spikes	\$43
S750CD	Double Sided w/ Custom Message 12"x 9"x 1/2" & 2 Steel spikes	\$58.50
S750WGF	Single Sided, Woodgrain Laminate 12"x 9"x 3/4" & 2 Steel spikes	\$62
S750DWGF	Double Sided Woodgrain Laminate 12"x 9"x 3/4" & 2 Steel spikes	\$82.75
S750CWGF	Single Sided Custom Message Woodgrain Laminate 12"x 9"x 3/4" & 2 Steel spikes	\$62
S750CDWGF	Double Sided Custom Message Woodgrain Laminate 12"x 9"x 3/4" & 2 Steel Spikes	\$82.75



S750C - CUSTOMIZE & ADD YOUR OWN MESSAGE!





PRICE MATCH GUARANTEE with Any Major Competitor

Engraved Laminated Directional Signs

S800/S825

Quad Series Directional Signs

Our S800 and S825 Quad Series signs are not only stylish, but with an integrated hand grip, are functional as well. A one hand grab is all that is necessary for relocation or re installation, and like our other products, are easy to maintain and look great for years to come. These signs measure 12"x10"x1/2" and are available on single post configuration in 12" and 18" lengths. Add a touch of elegance with our metallic fill option. [See pages 26-27]



S800	Single sided 12"x10"x1/2" on 2"x2"x12" Stake	\$67.50
S800D	Double sided 12"x10"x1/2" on 2"x2"x12" Stake	\$79.50
S800C	Single sided 12"x10"x1/2" with Custom Message on 2"x2"x12" Stake	\$67.50
S800CD	Double sided 12"x10"x1/2" with Custom Message on 2"x2"x12" Stake	\$79.50
S800WGF	Single Sided, Woodgrain Laminate 12" x 9" x 3/4" & 2 Steel spikes	\$86.50
S800DWGF	Double Sided Woodgrain Laminate 12" x 9" x 3/4" & 2 Steel spikes	\$103.75
S800CWGF	Single Sided Custom Message Woodgrain Laminate 12" x 9" x 3/4" & 2 Steel spikes	\$86.50
S800CDWGF	Double Sided Custom Message Woodgrain Laminate 12" x 9" x 3/4" & 2 Steel Spikes	\$103.75
S825	Single sided 12"x10"x1/2" on 2"x2"x18" Stake	\$69
S825D	Double sided 12"x10"x1/2" on 2"x2"x18" Stake	\$81.25
S825C	Single sided 12"x10"x1/2" with Custom Message on 2"x2"x18" Stake	\$69
S825CD	Double sided 12"x10"x1/2" with Custom Message on 2"x2"x18" Stake	
S825WGF	Single Sided Woodgrain Laminate, Post Mount 12" x 10" x 1/2" on 2"x2"x18"	\$88
S825DWGF	Double-Sided Woodgrain Laminate, Post Mount 12" x 10" x 1/2" on 2"x2"x18"	\$105.50
S825CWGF	Single Sided Woodgrain Laminate with Custom Message 12" x 10" x 1/2" on 2"x2"x18"	\$88
S825CDWGF	Double Sided Woodgrain Laminate with Custom Message 12" x 10" x 1/2" on 2"x2"x18"	\$105.50

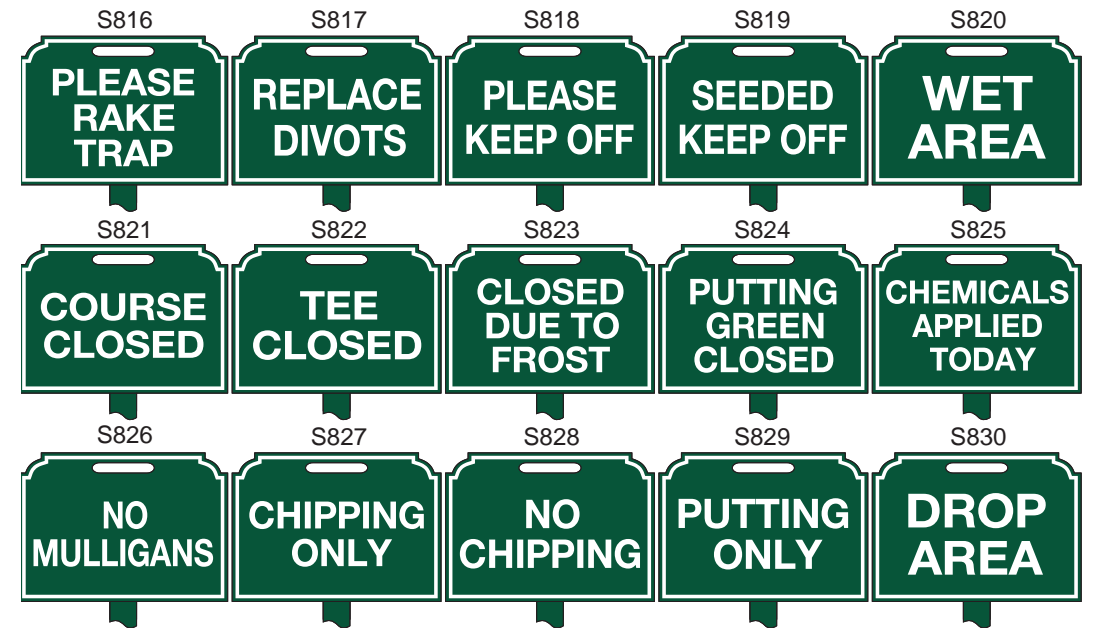
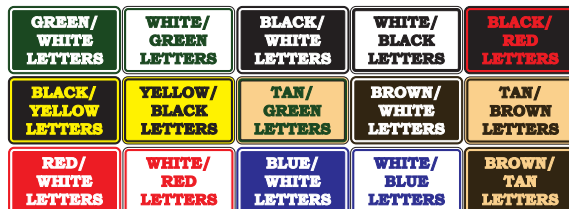
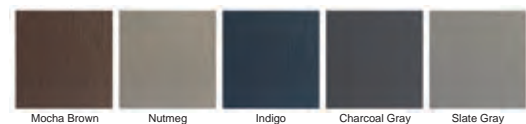

S800C - CUSTOMIZE & ADD YOUR OWN MESSAGE!

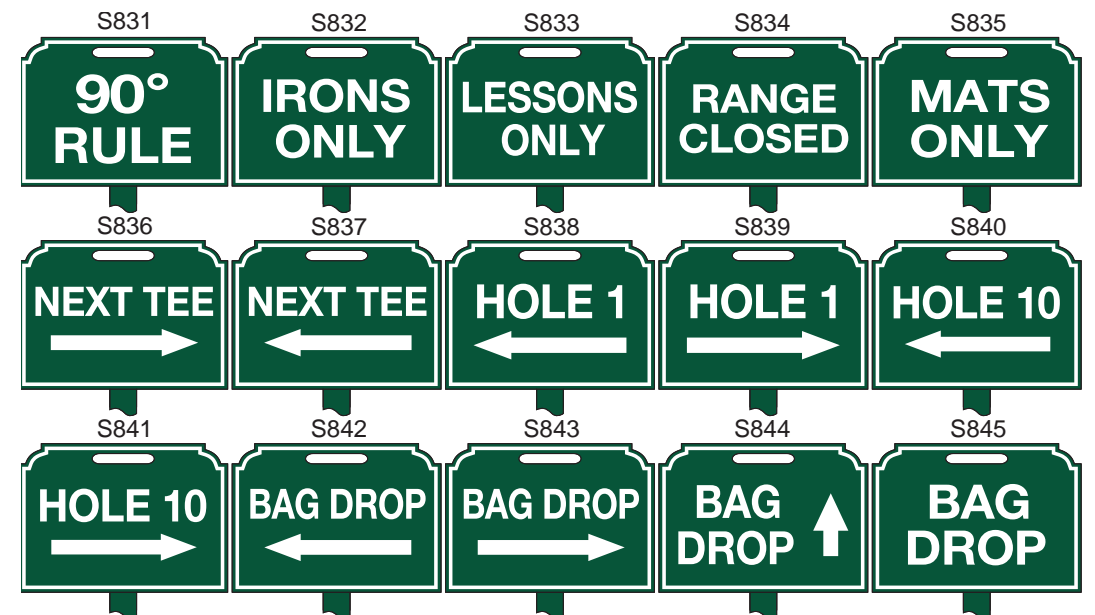



PRICE MATCH GUARANTEE with Any Major Competitor

Engraved Laminated Directional Signs

S850 Quad Series Directional Signs

Our S850 Quad Series features the same multilayer laminated construction and features as the S750 Ellipse Series, but with an angular design that speaks to your style. An integrated hand grip draws the eye to bold lettering, and makes it easy to pull these signs for relocation or re-installation. Add a touch of elegance with our metallic fill option. [See pages 26-27]



S850	Single Sided 12" x 10" x 1/2" with 2 Steel Spikes	\$51
S850D	Double Sided 12" x 10" x 1/2" with 2 Steel Spikes	\$63
S850C	Single Sided 12" x 10" x 1/2" w/ Custom Message & 2 Steel spikes	\$51
S850CD	Double Sided 12" x 10" x 1/2" w/ Custom Message & 2 Steel spikes	\$63
S850WGF	Single Sided Woodgrain Laminate 12" x 10" x 3/4" w/ Custom Message & 2 Steel spikes	\$70
S850DWGF	Double Sided Woodgrain Laminate 12" x 10" x 3/4" w/ Custom Message & 2 Steel spikes	\$87.25
S850CWGF	Single Sided Woodgrain Laminate 12" x 10" x 3/4" w/ Custom Message & 2 Steel spikes	\$70
S850CDWGF	Double Sided Woodgrain Laminate 12" x 10" x 3/4" w/ Custom Message & 2 Steel spikes	\$87.25



S850C - CUSTOMIZE & ADD YOUR OWN MESSAGE!



SIGNS



PRICE MATCH GUARANTEE *with Any Major Competitor*

Engraved Laminated Directional Signs

SGP Metallic Fill Signs

Engraved Laminated Directional Signs with Metallic Fill add a touch of elegance to our engraved, laminated signs with our Metallic Fill option. Available in Silver, Copper or Gold finishes that tell your guests they've arrived.

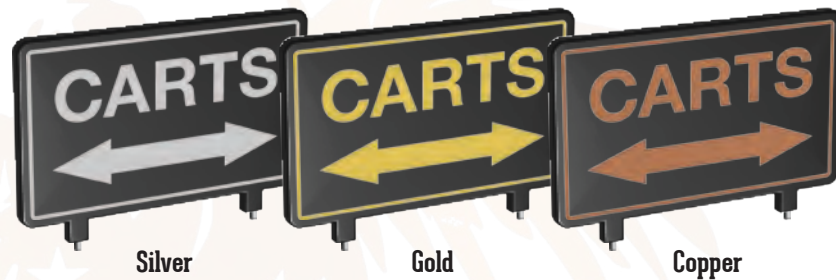

Silver

Gold

Copper



S100MF GOLD

S200MF GOLD

Metallic Fill Colors:

- Brilliant Gold
- Aztec Gold Mica
- Rose Gold
- Antique Copper
- Copper
- Brilliant Fire Copper
- Deep Copper
- Fire Red Copper
- Super Copper Mica
- Sparkle Bronze
- Fine Silver
- Iridescent Gold Green
- Iridescent Gold Red
- Iridescent Gold Blue
- Pearl Blue
- Pearl Violet

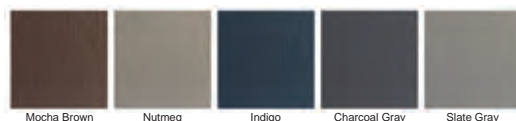

S100MF	Single Sided Sign with Metallic Fill, 10"x10"x1/2"	\$52.25
S100MFD	Double Sided Sign with Metallic Fill, 10"x10"x1/2"	\$69
S200MF	Single Sided Sign with Metallic Fill, 12"x6"x1/2"	\$57
S200MFD	Double Sided Sign with Metallic Fill, 12"x6"x1/2"	\$77
S400MF	Single Sided Sign with Metallic Fill, 15"x9"x1/2"	\$68
S400MFD	Double Sided Sign with Metallic Fill, 15"x9"x1/2"	\$84.25
S600MF	Single Sided Sign with Metallic Fill, 15"x14"x1/2"	\$97
S600MFD	Double Sided Sign with Metallic Fill, 15"x14"x1/2"	\$122.25
S700MF	Single Sided Sign with Metallic Fill, 12"x9"x1/2"	\$77.50
S700MFD	Double Sided Sign with Metallic Fill, 12"x9"x1/2"	\$97.75
S725MF	Single Sided Sign with Metallic Fill, 12"x9"x1/2"	\$79
S725MFD	Double Sided Sign with Metallic Fill, 12"x9"x1/2"	\$102.25
S750MF	Single Sided Sign with Metallic Fill, 12"x9"x1/2"	\$62
S750MFD	Double Sided Sign with Metallic Fill, 12"x9"x1/2"	\$82.75
S800MF	Single Sided Sign with Metallic Fill, 12"x10"x1/2"	\$86.50
S800MFD	Double Sided Sign with Metallic Fill, 12"x10"x1/2"	\$103.75
S825MF	Single Sided Sign with Metallic Fill, 12"x10"x1/2"	\$88
S825MFD	Double Sided Sign with Metallic Fill, 12"x10"x1/2"	\$105.50
S850MF	Single Sided Sign with Metallic Fill, 12"x10"x1/2"	\$70
S850MFD	Double Sided Sign with Metallic Fill, 12"x10"x1/2"	\$87.25
SC12X12MF	Single Sided Sign with Metallic Fill, 12"x12"x1/2"	\$98



SIGNS



S700MF GOLD



S800MF GOLD



S725MF GOLD



S825MF GOLD



S850MF GOLD



S400MF COPPER



S400MF SILVER



SC12x12MF GOLD



CUSTOMIZE & ADD YOUR OWN MESSAGE!



PRICE MATCH GUARANTEE *with Any Major Competitor*

Custom Engraved Laminated Directional Signs

Our most popular sizes are 12"x12", 12"x18" and 18"x24". Choose from these standard sizes or any size in between up to 48"x96"

Step 1: Choose a Size



Standard Sizes In Standard Colors

12" x 12" x 1/2	\$80
12" x 18" x 1/2	\$119
12" x 24" x 1/2	\$159
18" x 18" x 1/2	\$179
18" x 24" x 1/2	\$238
24" x 24" x 1/2	\$317
24" x 36" x 1/2	\$476
36" x 36" x 1/2	\$712
36" x 48" x 1/2	\$951
48" x 48" x 1/2	\$1,268
48" x 60" x 1/2	\$1,584
48" x 72" x 1/2	\$1,895
48" x 84" x 1/2	\$2,218
48" x 96" x 1/2	\$2,535

Step 2: Choose Your Shape

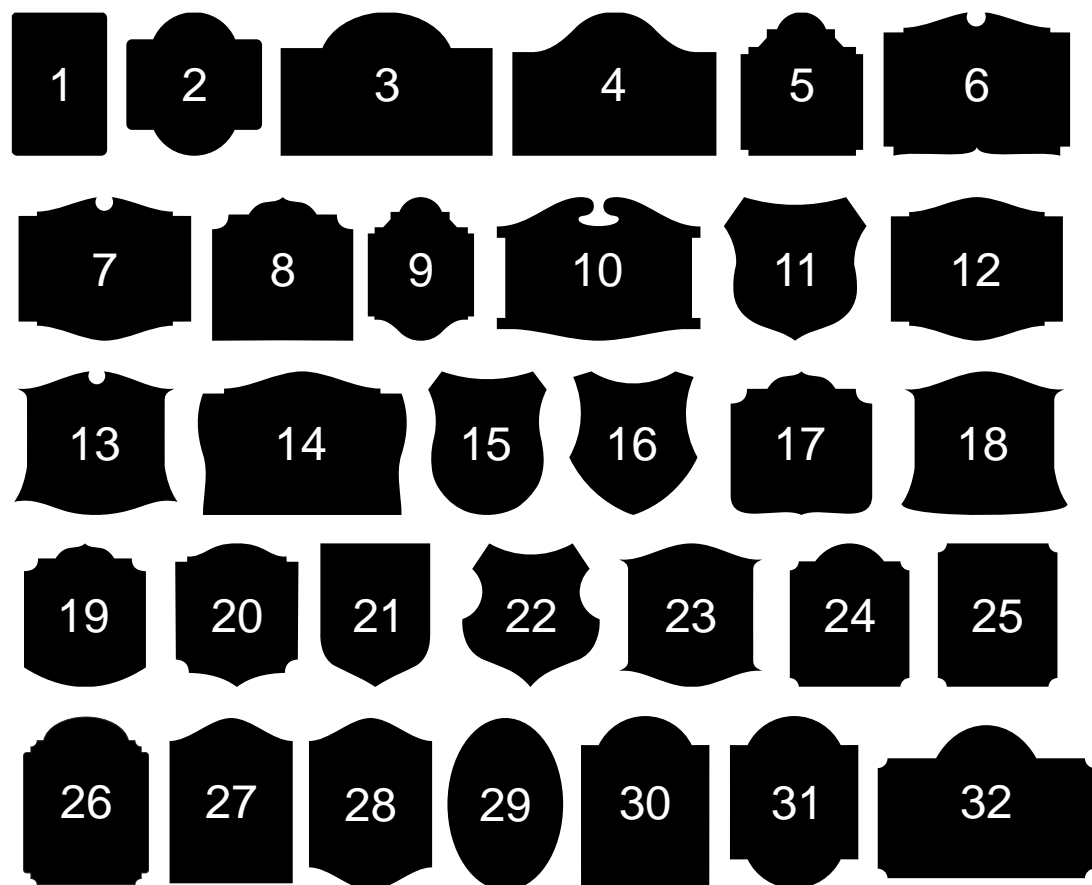

Step 3: Choose Your Colors

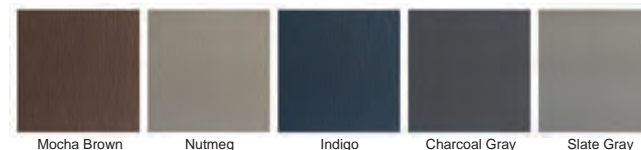
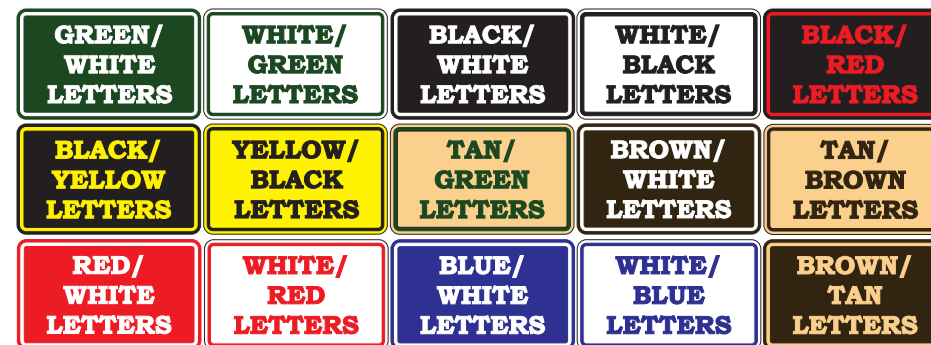

Metallic Gold, Silver and Copper Letters Available on Any Sign Color & Material

Step 4: Choose Your Message

Creating a custom sign with JF Manufacturing is as easy as answering a few questions. It only involves a few steps, from initial concept to the final product. We will help you answer the questions and lay out your design for your approval.

Here's a general guide to help define your needs.

1. Purpose: What is the sign for? (e.g., welcoming, directions, advertising, informational, safety)
2. Location: Where will it be placed and mounted? (e.g., on a wall, on a post, or in the ground)
3. Size: How large do you need it to be and what best fits the location?
4. Shape: What shape would best suit your design?
5. Color: What color scheme best matches your location? How noticeable should the sign be?
6. Content: What text and logo do you want to include?

Complimentary artwork with same day production. Tight deadline? We can help.



SIGNS

PRICE MATCH GUARANTEE *with Any Major Competitor*

Custom Aluminum Fairway Signs

S1900 S1900D

10" x 10"
Single or Double Sided

Our custom aluminum fairway signs are designed for both durability and clear visibility on the golf course. You can choose between two classic, high contrast color combinations: a green background with crisp white lettering or a white background with prominent green lettering. Both options ensure your signs stand out effectively against the natural landscape.

S1900	Single sided 10" x 10" Aluminum Sign	\$25
S1900D	Double sided 10" x 10" Aluminum Sign	\$30.50
S1900C	Single sided 10" x 10" Aluminum Sign with Custom Message	\$25
S1900CD	Double sided 10" x 10" Aluminum Sign with Custom Message	\$30.50



S1901 CARTS →	S1902 CARTS ←	S1903 CARTS →	S1904 NO CARTS BEYOND HERE	S1905 NO CARTS
S1906 CARTS SCATTER	S1907 KEEP CARTS 30 FEET FROM GREEN	S1908 NO CARTS BEYOND THIS POINT	S1909 KEEP CARTS ON PATH	S1910 CART PATH ONLY THIS HOLE
S1911 PARK GOLF CARTS HERE	S1912 SCATTER	S1913 PLEASE REPAIR BALL MARKS	S1914 REPAIR BALL MARKS ON GREEN	S1915 GROUND UNDER REPAIR
S1916 PLEASE RAKE TRAP	S1917 REPLACE DIVOTS	S1918 PLEASE KEEP OFF	S1919 SEEDS KEEP OFF	S1920 WET AREA
S1921 COURSE CLOSED	S1922 TEE CLOSED	S1923 CLOSED DUE TO FROST	S1924 PUTTING GREEN CLOSED	S1925 CHEMICALS APPLIED TODAY
S1926 NO MULLIGANS	S1927 CHIPPING ONLY	S1928 NO CHIPPING	S1929 PUTTING ONLY	S1930 DROP AREA
S1931 90° RULE	S1932 IRONS ONLY	S1933 LESSONS ONLY	S1934 RANGE CLOSED	S1935 MATS ONLY
S1936 NEXT TEE →	S1937 NEXT TEE ←	S1938 HOLE 1 ←	S1939 HOLE 1 →	S1940 HOLE 10 ←
S1941 HOLE 10 →	S1942 BAG DROP ←	S1943 BAG DROP →	S1944 BAG DROP ↑	S1945 BAG DROP



SIGNS

Custom Aluminum Signs

Custom aluminum signs offer unparalleled versatility and durability, making them an excellent choice for a wide array of applications. Aluminum can be effortlessly cut into virtually any custom shape or size, from intricate logos to large directional panels, ensuring your sign perfectly fits the unique space and aesthetic you envision. Furthermore, modern printing and finishing techniques allow for a complete spectrum of color options, enabling vibrant, full color graphics, and precise brand matching. Please, mention mounting hole location when ordering. Call to quote your next aluminum sign order.

Standard Sizes

12" x 12"	\$94
12" x 18"	\$109
12" x 24"	\$138
18" x 18"	\$130
18" x 24"	\$151
24" x 24"	\$179
24" x 36"	\$252
36" x 36"	\$308
36" x 48"	\$388
48" x 48"	\$436
48" x 60"	\$528
48" x 72"	\$620
48" x 84"	\$712
48" x 96"	\$808

A.	SC99-8x6	8" x 6"	\$89
B.	SC99-12x12	12" x 12"	\$94
C.	SC99-12x18	12" x 18"	\$109
D.	SC99-12x12	12" x 12"	\$94
E.	SC99-18x12	18" x 12"	\$109
F.	SC99-24x12	24" x 12"	\$138
G.	SC99-18x24	18" x 24"	\$151
H.	SC99-18x18	18" x 18"	\$130
I.	SC99-12x12	12" x 12"	\$94
J.	SC99-24x24	24" x 24"	\$179.50
K.	SC99-36x24	36" x 24"	\$252
L.	SC99-24x36	24" x 36"	\$252

A. NO ENTRY	G. TENNIS COURT RULES AND REGULATIONS	J. PLEASE KEEP CARTS IN THE FAIRWAY <i>Thank You</i>
B. INSTRUCTION NOT PERMITTED	GOLF COURSE MAINTENANCE FACILITY NO TRESPASSING AUTHORIZED PERSONNEL ONLY	K. CAUTION PLEASE WATCH FOR GOLF BALLS FROM THE 18TH TEE BOX
C. SMOKE FREE SMOKING IN DESIGNATED AREAS ONLY L.A.C.C. 17.04.645	H. STOP PROCEED WITH CAUTION	L. This shallow lake and the surrounding area are not maintained as a formal landscape. The area has been naturalized with tall grasses, wildflowers, and trees to provide food and shelter for wildlife. Please refrain from entering to minimize impact to this landscape.
D. CART PATH ONLY	I. DO NOT REMOVE GOLF BALLS FROM THE RANGE	



CUSTOMIZE & ADD YOUR OWN LOGO & MESSAGE!



SIGNS

PRICE MATCH GUARANTEE *with Any Major Competitor*

Custom Engraved Signs

\$1000

Custom Directional Signs

This is a small sampling of the many signs we make at our in house signs center. We can custom make just about any sign. If you do not see something you are looking for, give us a call.

A.	SPB100	36"x29"x1/2"	\$575
B.	SPB105	18"x24"x1/2"	\$238
C.	SPB110	12"x13"x1/2"	\$86
D.	SPB115	12"x12"x1/2"	\$80
E.	SPB120	12"x12"x1/2"	\$80
	SPB120	18"x18"x1/2"	\$179
F.	SPB125	12"x8"x1/2"	\$53
G.	SPB130	12"x8"x1/2"	\$53
H.	SPB135	12"x14"x1/2"	\$93
I.	SPB140	12"x18"x1/2"	\$119
J.	SPB145	16"x12"x1/2"	\$106
K.	SPB150	12"x48"x1/2"	\$425
L.	SPB155	18"x24"x1/2"	\$238
M.	SPB160	18"x24"x1/2"	\$238
N.	SPB165	18"x24"x1/2"	\$238

\$2000

Custom HOA Signs

Great for the golf course, parks and home owner's associations. We can make anything for your course, HOA or community needs.

\$3000

Pickleball Signs

Pickleball is one of the fastest-growing sports in the world, and we can make any sign you will need to outfit your court. From clear court specific rules and directional signage to durable scoreboards and custom signs that welcome players, we can tailor a solution to fit your facility's exact needs. Our signs are built to withstand the elements and provide a professional, clean look for your pickleball community.

\$4000

Custom Court Signs

Whether you have a tennis court, a bocce court, or any other recreational space, we can create the perfect sign for your guests. Our signs are fully customizable, allowing you to include anything from court rules and hours of operation to directional information and sponsor logos.



Posts

- GS1536 - 4x4x36" - \$78
- GS1548 - 4x4x48" - \$101
- GS1560 - 4x4x60" - \$127
- GS1572 - 4x4x72" - \$170

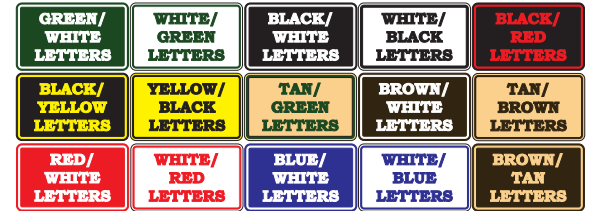
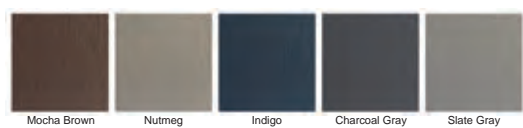
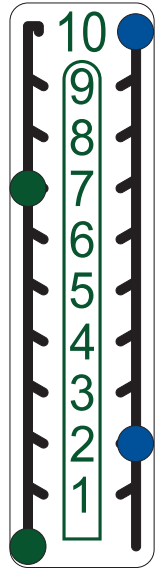
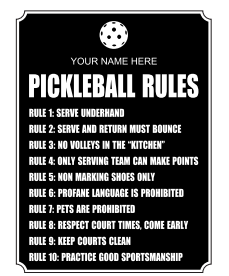
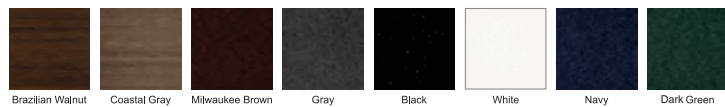

SIGNS



S1025 24"x18"x1/2"
Includes 5 Pin Placement Tiles - \$350



S1050 18"x24"x1/2"
Includes 1 Rule Tile - \$288



S1075 24"x18"x1/2"
Includes 6 Rule Tiles - \$375



S1100 18"x24"x1/2"
Includes 1 Rule Tile - \$288



S2025 18"x24"x1/2" - \$238



S2050 36"x24"x1/2" - \$476

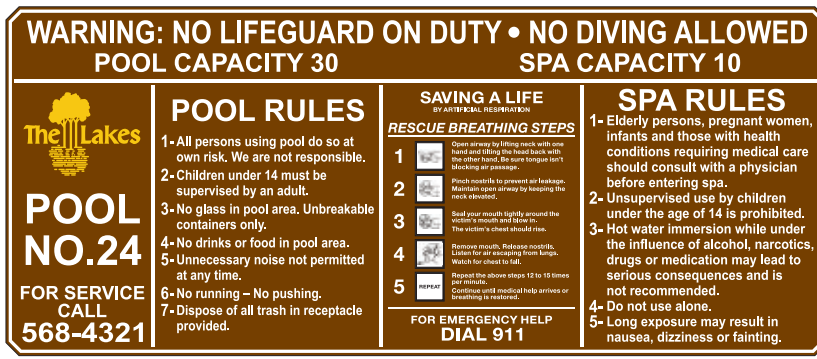

S2075 95"x40"x1/2" - \$2090

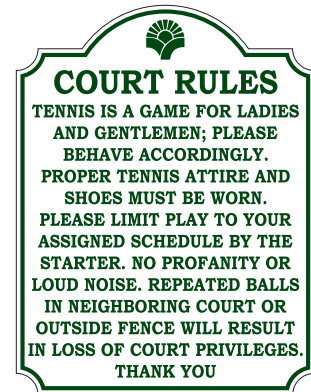

S4025 22"x28"x1/2" - \$339

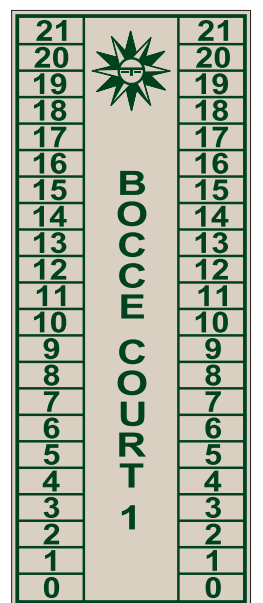

S4050 12"x30"x1/2" - \$198



CUSTOMIZE & ADD YOUR OWN LOGO & MESSAGE!



SIGNS

PRICE MATCH GUARANTEE *with Any Major Competitor*

Custom Course Entrance Signs & Stop Signs

\$5000

Welcome & Entrance Signs

Unlimited sizes, shapes and colors.

Call for a quote and let us design your perfect sign.

\$6000

Custom Course Layout Signs

Customized to your needs. Unlimited sizes and colors available and add posts or backers to complete the look. Common sizes are 48" x 48", 48" x 60", and 48" x 72" but any size can be created for your personal look.

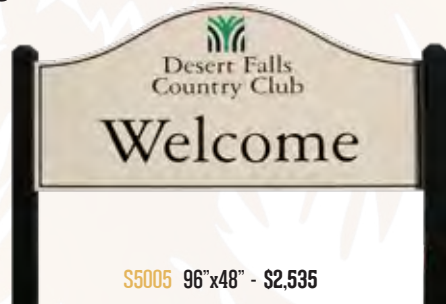

\$5005 96"x48" - \$2,535



\$5010 96"x48" - \$2,535

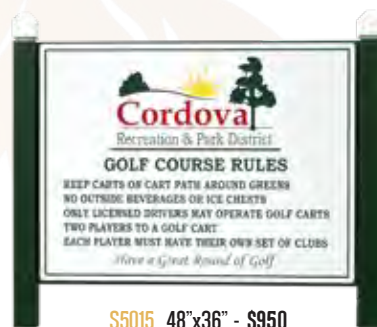

\$5015 48"x36" - \$950



\$5020 48"x36" - \$950



\$5025 48"x36" - \$950



\$5030 36"x24" - \$476



\$6010 48"x48" - \$2,550



\$6015 36"x36" - \$1,995

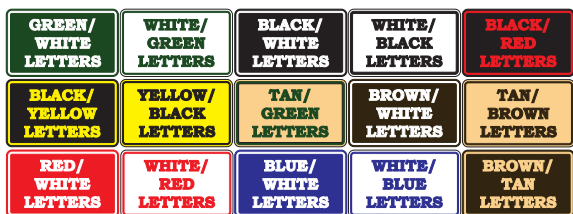
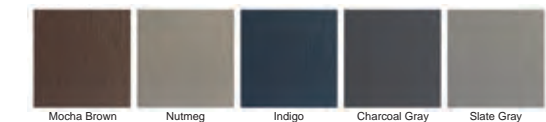

Posts

- GS1536 - 4x4x36" - \$78
- GS1548 - 4x4x48" - \$101
- GS1560 - 4x4x60" - \$127
- GS1572 - 4x4x72" - \$170



SIGNS

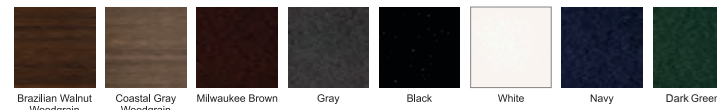

STOP SIGNS

Custom Stop Signs

A stop sign is a fundamental component of traffic management, acting as a critical safeguard to maintain order, prevent accidents, and protect the lives and safety of your golfers. Order a standard stop sign or let JFM Golf customize a sign incorporating a stop sign which suits the needs of your course.



\$925



\$2024



\$2124



\$2018

\$925-12	Laminated Plastic Stop Sign, 12"	\$64
\$925-15	Laminated Plastic Stop Sign, 15"	\$99
\$925-18	Laminated Plastic Stop Sign, 18"	\$154
\$925-24	Laminated Plastic Stop Sign, 24"	\$270
\$2024	Combination Directional/Stop Sign, 18"x24"	\$410
\$2124	Stop Sign and 30"x30" backer mounted on two 4x4" x 84" recycled plastic lumber posts	\$1,095
\$2018	Combination Directional/Stop Sign, 12"x18"	\$317



CUSTOMIZE & ADD YOUR OWN LOGO & MESSAGE!



SIGNS

PRICE MATCH GUARANTEE with Any Major Competitor

Bronze & Aluminum Signs

Cast Bronze Signage for Your Entire Course

Our team has been creating the finest bronze and aluminum golf course signs for clubs around the world for years. We can take your ideas and bring them to life in cast bronze metal, adding a sense of sophistication and class to any golf course or development that no other material can achieve.

Our skilled craftsmen specialize in creating ultra durable, personalized cast bronze metal golf signs. We can incorporate your course's logo, hole information, or any other custom information you need. These signs are built to last, providing a timeless and elegant look for your entire course.



Beveled Marker

Size	Bronze	Price	Aluminum	Price
6"	JF-BEV-06-BZ	\$91	JF-BEV-06-AL	\$76
8"	JF-BEV-08-BZ	\$139	JF-BEV-08-AL	\$113
10"	JF-BEV-10-BZ	\$217	JF-BEV-10-AL	\$178
10"x8"	JF-BEV-108-BZ	\$217	JF-BEV-108-AL	\$178

Round Tee Distance Marker

Size	Bronze	Price	Aluminum	Price
6"	JF-TDM-06-BZ	\$88	JF-TDM-06-AL	\$71
8"	JF-TDM-08-BZ	\$121	JF-TDM-08-AL	\$91
10"	JF-TDM-10-BZ	\$154	JF-TDM-10-AL	\$115

Rectangle Tee Distance Marker

Size	Bronze	Price	Aluminum	Price
8"x6"	JF-TDM-1006-BZ	\$99	JF-TDM-1006-AL	\$64
10"x8"	JF-TDM-1008-BZ	\$158	JF-TDM-1008-AL	\$119
12"x10"	JF-TDM-1210-BZ	\$237	JF-TDM-1210-A	\$178

Square Distance Marker

Size	Bronze	Price	Aluminum	Price
5"x5"	JF-MAS-55-BZ	\$59	JF-MAS-55-AL	\$45
6"x6"	JF-MAS-66-BZ	\$68	JF-MAS-66-AL	\$53
7"x7"	JF-MAS-77-BZ	\$79	JF-MAS-77-AL	\$61
8"x8"	JF-MAS-88-BZ	\$107	JF-MAS-88-AL	\$79
10"x10"	JF-MAS-10-BZ	\$171	JF-MAS-10-AL	\$102
12"x12"	JF-MAS-12-BZ	\$226	JF-MAS-12-AL	\$157

Rectangle Distance Marker

Size	Bronze	Price	Aluminum	Price
5"x3"	JF-MAR-53-BZ	\$51	JF-MAR-53-AL	\$42
6"x4"	JF-MAR-64-BZ	\$57	JF-MAR-64-AL	\$45
7"x5"	JF-MAR-75-BZ	\$70	JF-MAR-75-AL	\$53
8"x6"	JF-MAR-86-BZ	\$82	JF-MAR-86-AL	\$63
9"x7"	JF-MAR-97-BZ	\$117	JF-MAR-97-AL	\$79
10"x7"	JF-MAR-17-BZ	\$123	JF-MAR-17-AL	\$90
10"x8"	JF-MAR-18-BZ	\$140	JF-MAR-18-AL	\$94



In Ground Yardage Markers

In Ground Yardage markers are an essential element of play for any golf course. Properly marked courses can speed the pace of play and make for a more enjoyable golf experience. Multiple border options are available.



SIGNS

Pyramid Markers

Cart Path markers come in standard yardages: 100, 150, 200, 250. Custom yardages are available for an additional charge. Pyramid markers come standard with two threaded studs for mounting. Marker measurements: 9" L x 5.25" W x 1.25" H



Pyramid Markers

Sign Type	Product #	Price
Bronze Pyramid Marker	JF-PYZ-0-BZ	\$79
Custom Bronze Pyramid Marker	JF-PYZ-CUS-BZ	\$105
Aluminum Pyramid Marker	JF-PYZ-0-AL	\$55
Custom Aluminum Pyramid Marker	JF-PYZ-CUS-AL	\$79



Round Distance Marker

Size	Bronze	Price	Aluminum	Price
5"	JF-MAC-05-BZ	\$59	JF-MAC-05-AL	\$45
6"	JF-MAC-06-BZ	\$68	JF-MAC-06-AL	\$53
7"	JF-MAC-07-BZ	\$79	JF-MAC-07-AL	\$61
8"	JF-MAC-08-BZ	\$107	JF-MAC-08-AL	\$79
10"	JF-MAC-10-BZ	\$137	JF-MAC-10-AL	\$102
12"	JF-MAC-12-BZ	\$194	JF-MAC-12-AL	\$157



Round Logo Marker

Size	Bronze	Price	Aluminum	Price
5"	JF-LMC-05-BZ	\$59	JF-LMC-05-AL	\$46
6"	JF-LMC-06-BZ	\$68	JF-LMC-06-AL	\$54
7"	JF-LMC-07-BZ	\$79	JF-LMC-07-AL	\$61
8"	JF-LMC-08-BZ	\$108	JF-LMC-08-AL	\$79
10"	JF-LMC-10-BZ	\$138	JF-LMC-10-AL	\$103
12"	JF-LMC-12-BZ	\$194	JF-LMC-12-AL	\$157



Oval Distance Marker

Size	Bronze	Price	Aluminum	Price
5"x3"	JF-MAO-53-BZ	\$49	JF-MAO-53-AL	\$41
6"x4"	JF-MAO-64-BZ	\$56	JF-MAO-64-AL	\$46
7"x4"	JF-MAO-74-BZ	\$59	JF-MAO-74-AL	\$48
7"x5"	JF-MAO-75-BZ	\$68	JF-MAO-75-AL	\$49
8"x6"	JF-MAO-86-BZ	\$78	JF-MAO-86-AL	\$61
10"x7"	JF-MAO-17-BZ	\$108	JF-MAO-17-AL	\$88
10"x8"	JF-MAO-18-BZ	\$123	JF-MAO-18-AL	\$89



Oval Logo Marker

Size	Bronze	Price	Aluminum	Price
5"x3"	JF-LMO-53-BZ	\$49	JF-LMO-53-AL	\$41
6"x4"	JF-LMO-64-BZ	\$56	JF-LMO-64-AL	\$46
7"x4"	JF-LMO-74-BZ	\$59	JF-LMO-74-AL	\$48
7"x5"	JF-LMO-75-BZ	\$68	JF-LMO-75-AL	\$49
8"x6"	JF-LMO-86-BZ	\$78	JF-LMO-86-AL	\$61
10"x7"	JF-LMO-17-BZ	\$108	JF-LMO-17-AL	\$88
10"x8"	JF-LMO-18-BZ	\$123	JF-LMO-18-AL	\$90



PRICE MATCH GUARANTEE with Any Major Competitor

Bronze & Aluminum Signs



In-Ground Range Plaques

Size	Bronze	Price	Aluminum	Price
12"x14"	JF-RM-1214-BZ	\$610	JF-RM-1214-AL	\$473
12"x18"	JF-RM-1218-BZ	\$866	JF-RM-1218-AL	\$605
14"x20"	JF-RM-1420-BZ	\$1,015	JF-RM-1420-AL	\$787
14"x22"	JF-RM-1422-BZ	\$1,104	JF-RM-1422-AL	\$837
16"x22"	JF-RM-1622-BZ	\$1,279	JF-RM-1622-AL	\$987
18"x24"	JF-RM-1824-BZ	\$1,563	JF-RM-1824-AL	\$1,227

Flag Identification Range Markers



Small Marker - 3,4,5 Flags

Size	Bronze	Price	Aluminum	Price
5"x7"	JF-FF-3FLAG-BZ	\$120	JF-FF-3FLAG-AL	\$90
5"x9"	JF-FF-4FLAG-BZ	\$148	JF-FF-4FLAG-AL	\$110
5"x10"	JF-FF-5FLAG-BZ	\$168	JF-FF-5FLAG-AL	\$130



Vertical Marker - 6 to 7 Flags

Size	Bronze	Price	Aluminum	Price
5"x12"	JF-FF-6FLAG-BZ	\$189	JF-FF-6FLAG-AL	\$148
5"x13"	JF-FF-7FLAG-BZ	\$209	JF-FF-7FLAG-AL	\$168



Medium Marker - Up to 5 Flags

Size	Bronze	Price	Aluminum	Price
10"x8"	JF-FF-1008-BZ	\$199	JF-FF-1008-AL	\$148
12"x10"	JF-FF-1210-BZ	\$296	JF-FF-1210-AL	\$227



Round Marker - Up to 7 Flags

Size	Bronze	Price	Aluminum	Price
10"	JF-FF-10-BZ	\$137	JF-FF-10-AL	\$106
11"	JF-FF-11-BZ	\$155	JF-FF-11-AL	\$120
12"	JF-FF-12-BZ	\$180	JF-FF-12-AL	\$140



12" Stop Sign

Description	Product #	Price
BRONZE BRUSHED SATIN	JF-SS-1212-BS	\$261
ALUMINUM WITH BRUSHED SATIN	JF-SS-1212-AS	\$165
ALUMINUM WITH ROLLED GOLD	JF-SS-1212-AG	\$165



18" Stop Sign

Description	Product #	Price
BRONZE BRUSHED SATIN	JF-SS-1818-BS	\$444
ALUMINUM WITH BRUSHED SATIN	JF-SS-1818-BS	\$347
ALUMINUM WITH ROLLED GOLD	JF-SS-1818-BS	\$347



18" Yield Sign

Description	Product #	Price
BRONZE BRUSHED SATIN	JF-YS-18-BS	\$444
ALUMINUM WITH BRUSHED SATIN	JF-YS-18-AS	\$340



Golf Carts Stop - 10"x16"

Description	Product #	Price
BRONZE BRUSHED SATIN	JF-TR-CART-BS	\$415
ALUMINUM WITH BRUSHED SATIN	JF-TR-CART-AS	\$268
ALUMINUM WITH ROLLED GOLD	JF-TR-CART-AG	\$268



12" Cart Crossing

Description	Product #	Price
BRONZE BRUSHED SATIN	JF-TR-XING-BS	\$268
ALUMINUM WITH BRUSHED SATIN	JF-TR-XING-AS	\$182



12" Private Property - Golf Carts

Description	Product #	Price
BRONZE BRUSHED SATIN	JF-PS-12-BZ	\$261
ALUMINUM WITH BRUSHED SATIN	JF-PS-12-AS	\$165
ALUMINUM WITH ROLLED GOLD	JF-PS-12-AG	\$165



CUSTOMIZE & ADD YOUR OWN LOGO & MESSAGE!



SIGNS

PRICE MATCH GUARANTEE with Any Major Competitor

Bronze & Aluminum Signs



Dynamic Custom Signage

Custom made to fit your courses message requirements. Our unique message slider system allows for quick and easy message changes to effectively communicate with your patrons.

- Pin Location
- Course Rule Signs
- Club Champions
- Driving Range
- Parking Designations

Dynamic Custom Signage

Size	Bronze	Price	Aluminum	Price
10"x12"	JF-CR-1012-BZ	\$461	JF-CR-1012-AL	\$360
12"x14"	JF-CR-1214-BZ	\$635	JF-CR-1214-AL	\$461
12"x18"	JF-CR-1218-BZ	\$866	JF-CR-1218-AL	\$572
14"x20"	JF-CR-1420-BZ	\$1,035	JF-CR-1420-AL	\$819
14"x22"	JF-CR-1422-BZ	\$1,042	JF-CR-1422-AL	\$862
16"x22"	JF-CR-1622-BZ	\$1,301	JF-CR-1622-AL	\$1,012
18"x24"	JF-CR-1824-BZ	\$1,576	JF-CR-1824-AL	\$1,237

Custom Cast Wayfinding

Our wayfinding packages use complimenting designs, materials, colors and styles which communicate an aesthetic sensibility, sense of purpose, and a welcoming feeling. We can also incorporate logos or custom graphics that will help add brand identity to your commercial or residential development. Call for Quote



SIGNS

RESTROOM

Restroom - 16"x4"

Description	Product #	Price
BRONZE	JF-RR-1604-BZ	\$189
ALUMINUM	JF-RR-1604-AS	\$121
ALUMINUM WITH ROLLED GOLD	JF-RR-1604-AG	\$121

LADIES LOCKER ROOM

MEN'S LOCKER ROOM

Locker Room - 21"x6"

Description	Product #	Price
BRONZE	JF-LOCK-2106-BZ	\$347
ALUMINUM	JF-LOCK-2106-AS	\$247
ALUMINUM WITH ROLLED GOLD	JF-LOCK-2106-AG	\$247



Slippery When Wet - 12"x10"

Description	Product #	Price
BRONZE	JF-SLIP-1210-BZ	\$347
ALUMINUM	JF-SLIP-1210-AS	\$227
ALUMINUM WITH ROLLED GOLD	JF-SLIP-1210-AG	\$227

PRO SHOP

Pro Shop - 15"x4"

Description	Product #	Price
BRONZE	JF-PRO-1504-BZ	\$179
ALUMINUM	JF-PRO-1504-AS	\$121
ALUMINUM WITH ROLLED GOLD	JF-PRO-1504-AG	\$121



Cart Path Only - 13"x7"

Description	Product #	Price
BRONZE	JF-CPOTH-1307-BZ	\$268
ALUMINUM	JF-CPOTH-1307-AS	\$168
ALUMINUM WITH ROLLED GOLD	JF-CPOTH-1307-AG	\$168



Today's Cart Rules - 12"x14"

Description	Product #	Price
BRONZE	JF-TCR-1214-BZ	\$494
ALUMINUM	JF-TCR-1214-AS	\$326
ALUMINUM WITH ROLLED GOLD	JF-TCR-1214-AG	\$326



CUSTOMIZE & ADD YOUR OWN LOGO & MESSAGE!



SIGNS

PRICE MATCH GUARANTEE *with Any Major Competitor*

Bronze & Aluminum Signs



Single Sided Mobile Info Arrows - 10"x4"

Message	Bronze	Price	Aluminum	Price
Cars Left	JF-MIA-CL-BZ	\$61	JF-MIA-CL-AL	\$49
Carts Right	JF-MIA-CR-BZ	\$61	JF-MIA-CR-AL	\$49
Next Tee Left	JF-MIA-NTL-BZ	\$61	JF-MIA-NTL-AL	\$49
Next Tee Right	JF-MIA-NTR-BZ	\$61	JF-MIA-NTR-AL	\$49



Single Sided Mobile Info Bell End - 10"x5"

Message	Bronze	Price	Aluminum	Price
*Choose Message from List Below	JF-MIB-BELL-BZ	\$71	JF-MIB-BELL-AL	\$53



Single Sided Mobile Info Rectangle - 10"x5"

Message	Bronze	Price	Aluminum	Price
*Choose Message from List Below	JF-MIR-RECT-BZ	\$61	JF-MIR-RECT-AL	\$49

Standard Messages

NO CARTS 1001	KEEP CARTS ON PATHS 1002	PLEASE KEEP OFF 1003	IRONS ONLY 1004	USE 90 RULE 1005
←NEXT TEE 1006	NEXT TEE → 1007	CARTS → 1008	←CARTS 1009	NO CHIPPING 1010
REPAIR BALL MARKS 1011	SLOW 1012	NO CARTS BEYOND HERE 1013	CART PATH ONLY 1014	DROP AREA 1015



SIGNS



Directional Signs

Size	Bronze	Price	Aluminum	Price
6"x12"	JF-DS-0612-BZ	\$368	JF-DS-0612-AL	\$227
8"x10"	JF-DS-0810-BZ	\$372	JF-DS-0810-AL	\$239
8"x12"	JF-DS-0812-BZ	\$387	JF-DS-0812-AL	\$252
9"x12"	JF-DS-0912-BZ	\$419	JF-DS-0912-AL	\$296
10"x12"	JF-DS-1012-BZ	\$434	JF-DS-1012-AL	\$336
10"x14"	JF-DS-1014-BZ	\$513	JF-DS-1014-AL	\$420
12"x14"	JF-DS-1214-BZ	\$610	JF-DS-1214-AL	\$473
12"x16"	JF-DS-1216-BZ	\$694	JF-DS-1216-AL	\$533
12"x18"	JF-DS-1218-BZ	\$857	JF-DS-1218-AL	\$555
12"x20"	JF-DS-1220-BZ	\$1,008	JF-DS-1220-AL	\$672
14"x20"	JF-DS-1420-BZ	\$1,015	JF-DS-1420-AL	\$787
14"x22"	JF-DS-1422-BZ	\$1,104	JF-DS-1422-AL	\$839
16"x22"	JF-DS-1622-BZ	\$1,279	JF-DS-1622-AL	\$988
18"x24"	JF-DS-1824-BZ	\$1,563	JF-DS-1824-AL	\$1,227



Available Shapes





SIGNS

PRICE MATCH GUARANTEE with Any Major Competitor

Bronze & Aluminum Tee Signs



Bronze Tee Signs

Size	Signature	Price	Classic	Price	Imperial	Price
10"x16"	JF-TS-1016-BZ	\$548	JF-TC-1016-BZ	\$577	JF-TI-1016-BZ	\$688
12"x14"	JF-TS-1214-BZ	\$563	JF-TC-1214-BZ	\$605	JF-TI-1214-BZ	\$714
12"x18"	JF-TS-1218-BZ	\$736	JF-TC-1218-BZ	\$783	JF-TI-1218-BZ	\$893
14"x20"	JF-TS-1420-BZ	\$966	JF-TC-1420-BZ	\$1,015	JF-TI-1420-BZ	\$1,124
14"x22"	JF-TS-1422-BZ	\$834	JF-TC-1422-BZ	\$1,104	JF-TI-1422-BZ	\$1,215
16"x22"	JF-TS-1622-BZ	\$1,227	JF-TC-1622-BZ	\$1,272	JF-TI-1622-BZ	\$1,380
18"x24"	JF-TS-1824-BZ	\$1,946	JF-TC-1824-BZ	\$2,040	JF-TI-1824-BZ	\$2,147

Aluminum Tee Signs

Size	Signature	Price	Classic	Price	Imperial	Price
10"x16"	JF-TS-1016-AL	\$410	JF-TC-1016-AL	\$446	JF-TI-1016-AL	\$558
12"x14"	JF-TS-1214-AL	\$431	JF-TC-1214-AL	\$471	JF-TI-1214-AL	\$577
12"x18"	JF-TS-1218-AL	\$568	JF-TC-1218-AL	\$605	JF-TI-1218-AL	\$714
14"x20"	JF-TS-1420-AL	\$751	JF-TC-1420-AL	\$787	JF-TI-1420-AL	\$898
14"x22"	JF-TS-1422-AL	\$798	JF-TC-1422-AL	\$834	JF-TI-1422-AL	\$945
16"x22"	JF-TS-1622-AL	\$956	JF-TC-1622-AL	\$990	JF-TI-1622-AL	\$1,096
18"x24"	JF-TS-1824-AL	\$1,173	JF-TC-1824-AL	\$1,213	JF-TI-1824-AL	\$1,319



Sponsor Signs

A great way to generate extra revenue or identify important donors. Sponsor signs can be mounted along side your tee signs in a variety of ways.

Includes set of 2 bracket clips

JF-MTG-SPONSOR - Call for Quote



SIGNS



Direct Mount

Sign is fastened through post and threads into bosses on back of sign with provided stainless steel hardware



Side Mount

Aluminum "L-brackets" are secured to back of sign. Brackets are then secured to pre-drilled post using provided stainless steel hardware.

Hanger Arm Mount

Aluminum arm is fastened to the back of sign and attached to post. Sign can mount off either side of post.

Double Post

Used to mount larger signs, similar to "Direct Mount" style. Posts come pre-drilled to match sign and include all required hardware.

Aluminum Powder Coated Posts

Length	3" Sq. Price	4" Sq. Price	3" Round Price	4" Round Price
6'-0"	\$148	\$254	\$148	\$254
7'-0"	\$231	\$279	\$231	\$279
8'-0"	\$247	\$293	\$247	\$293
Add Hanger Mount Brackets	\$148	\$148	\$148	\$148
Add Side Mount Brackets	\$56	\$56	\$56	\$56
Add Ball Finial To Post	\$53	\$63	\$71	\$83



CUSTOMIZE & ADD YOUR OWN LOGO & MESSAGE!



RANGE / PRACTICE AREA

PRICE MATCH GUARANTEE with Any Major Competitor

Yardage Easels

S350
S360

Yardage Easels

Our popular yardage easels are made from engraved, laminated plastic and are extraordinarily durable in any climate. Easy to clean and maintain, these easels can be single or double sided and are available 16"x24", 22"x32" and 32"x40" sizes. Choose from a wide variety of stock colors and personalize it with your own logo. [Please note: Additional fees apply to all easels depending on the setup. Call us today and let us design a custom easel for you!] Call for number and slide pricing.



S351-4

S350-6D

S350-6L



S352-6D



S352-5L



S350-4CL



S360



S360



S360



S365

- S351-4 Single Sided Today's Yardage Easel includes 4 yardages and numbers. 16"x24" \$394
 - S351-4D Double Sided Today's Yardage Easel includes 4 yardages and numbers. 16"x24" \$574
 - S350-6 Single Sided Today's Yardage Easel includes 6 yardages and numbers. 22"x32" \$567
 - S350-6D Double Sided Today's Yardage Easel includes 6 yardages and numbers 22"x32" \$921
 - S350-6L Single Sided Today's Yardage Easel includes 6 yardages, your logo and numbers 22"x32" \$672
 - S352-6 Single Sided Today's Yardage Easel includes 6 yardages and numbers and includes 15" clock. 32"x40" \$788
 - S352-6D Double Sided Today's Yardage Easel includes 6 yardage and numbers and includes 15" clocks. 32"x40" \$1,339
 - S350-4CL Single Sided Today's Yardage Easel includes 4 yardages and numbers, your logo and 15" clock. 22"x32" \$706
 - S360 Our Custom Easel with Arch Trim. Customize it in any size, colors, and your logo. Our possibilities are endless Call for quote
 - S365 Single Sided Tribute Collection Easel 27"x40" \$969
 - S365D Double Sided Tribute Collection Easel 27"x40" \$1,895
- This Customizable Easel Will Make A Bold Statement On Your Range. It Can Be Ordered In A Variety Of Colors With Up To 8 Yardages And Comes Complete With Aluminum Slides And Interchangeable Numbers. 27" Wide x 40" Tall.

RANGE PRACTICE AREA

CUSTOMIZE & ADD YOUR OWN LOGO & MESSAGE!



RANGE / PRACTICE AREA

PRICE MATCH GUARANTEE *with Any Major Competitor*

Custom Directional Clock Easels

S370

Custom Directional Clock Easels are tailor made to perfectly suit your specific needs and aesthetic. You have complete flexibility with sizing, allowing the easel to be made to any dimensions required for your space. The most popular sizes are 25"x42" and can range up to 36" wide and up to 60" tall. Let us design a custom clock easel for you today that combines functionality with personalized style!



S370



S370



GC302, GC303



GC307



GC307-L

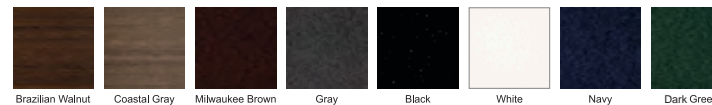
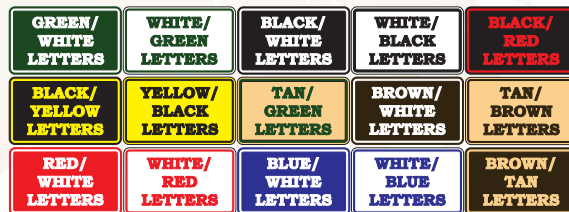
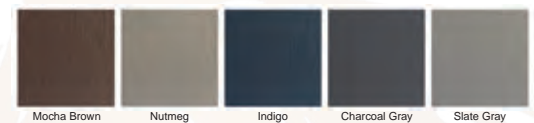

GC100-15



GC225C



GC225



GC227



GC400

GC100-15	Single Sided 15" Clock Easel 18"x24"x1/2"	\$371
GC100-15D	Double Sided 15" Clock Easel 18"x24"x1/2"	\$409
GC100-18	Single Sided 18" Clock Easel 21"x24"x1/2"	\$520
GC100-18D	Double Sided 18" Clock Easel 21"x24"x1/2"	\$817
GC225C	Single Sided Clock Easel with 18" Clock, arch and 2"x2" frame and logo. Call us and we can customize one for you today! 27"x35"x5"	\$701
GC225CD	Double Sided Clock Easel with 18" Clock, arch and 2"x2" frame and logo. Call us and we can customize one for you today!	\$1,192
GC225	Single Sided 18" Clock Easel with arch and 2"x2" frame. 26" x 26"	\$571
GC225D	Double Sided 18" Clock Easel with arch and 2"x2" frame.	\$1,110
GC227	Tribute Collection Single Sided 18" Clock Easel	\$710
GC400	Single Sided 15" Clock Slatted Easel	\$305
GC400D	Double Sided 15" Clock Slatted Easel	\$378

RANGE PRACTICE AREA



CUSTOMIZE & ADD YOUR OWN LOGO & MESSAGE!



RANGE / PRACTICE AREA

PRICE MATCH GUARANTEE with Any Major Competitor

Clock Stands & Signage

It's time to play. Our classic design clocks are large and easy to read for any player. They are available in 15" and 18" sizes and can be mounted to a recycled backer and post in your choice of five colors.

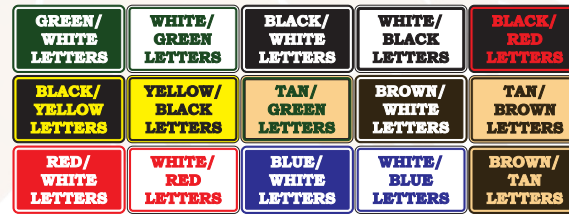

GC101 Clock on Post & Base



GC101-18



GC101-15

- GC101-15 Single Sided Clock on Post, 15" Bronze Clock with plastic lumber backer and post \$473
- GC101-18 Single Sided Clock on Post, 18" Silver Clock \$520
- GC101-15D Double Sided Clock on Post, 15" Bronze Clock with plastic lumber backer and post \$770
- GC101-18D Double Sided Clock on Post, 18" Silver Clock \$817

S350 Replacement Easel Numbers

- S350-1N 2"x2" Number \$7.50
- S350-1N 2"x3" Number \$8.50
- S350-1N 3"x3" Number \$9.50



S1400 Aluminum Number Sliders

- SLIDE26 Aluminum Slide 2"x6" \$18
- SLIDE36 Aluminum Slide 3"x6" \$25
- SLIDE318 Aluminum Slide 3"x18" \$39



S1400 Rule Tiles

- S1400-212 2"x12" Rule Tiles \$18
- S1400-312 3"x12" Rule Tiles \$36
- S1400-318 3"x18" Rule Tiles \$44

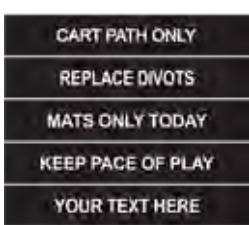

Lost your easel numbers or directional tiles, or need to purchase more? We've got you covered and they're available in many sizes. The most popular are the 2" and 3" numbers and the 3"x18" directional tiles, but we can customize anything.

CUSTOMIZE & ADD YOUR OWN LOGO & MESSAGE!



RANGE PRACTICE AREA



Clock 15 - Replacement 15" Atomic Clock - \$114



Clock 18 - Replacement 18" Atomic Clock - \$218



\$1300



\$1500



\$1200C



\$1200



\$1400GP

\$1300 Green Speed sign. Numbers are sold separately. See page 44 for ordering and pricing. 12"x12"x1/2" \$86

See page 50 for ordering and pricing

\$1500 Today's Pin Placement Sign. Numbers are sold separately. See page 44 for ordering and pricing. 12"x12"x1/2" \$86

See page 50 for ordering and pricing

\$1200C Our \$1200 sign customized to fit your needs. Includes logo and clock. \$460

\$1200 Pace of Play sign, 18"x30"x1/2" and includes 15" clock \$399

\$1400GP Today's Course Rules sign with metallic filled letters, 22"x32"x1/2". Includes up to six rule tiles and a 15" clock. Customize with any size or color and add your logo for an additional fee. \$749

\$1400 Today's Course Rules sign 22"x32"x1/2". Includes up to six rule tiles and a 15" clock. Customize with any size or color and add your logo for an additional fee. \$678

GC305L Double sided 22"x32" clock easel includes 15" clock and logo. \$571

GC225D Double Sided 18" Clock Easel with arch and 2"x2" frame. \$385



\$1400



GC305



PRICE MATCH GUARANTEE with Any Major Competitor

Range & Tee Signs

Our laminate plastic signs are made of multiple layers of contrasting colors. Virtually maintenance free and will not rot or delaminate. They will handle just about any abuse and are available in unlimited colors. Stock colors shown to the right.

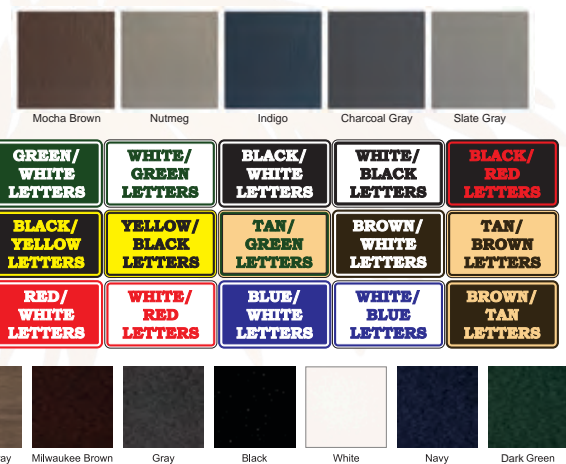

S385



S382



S380



S381



S3181



S3182

- S385 Tribute Collection Proper Divot Single Sided Easel \$720
- S382 Proper Divot Pattern Easel, Single Sided, 22"x 32" with arch trim and 2"x 2" frame \$583
- S382D Proper Divot Pattern Easel, Double Sided, 22"x 32" with arch trim and 2"x 2" frame \$831
- S380 Proper Divot Pattern Easel, Single Sided, 16"x 24" \$371
- S380D Proper Divot Pattern Easel, Double Sided, 16"x 24" \$529
- S381 Proper Divot Pattern Easel, Single Sided, 22"x 32" \$498
- S381D Proper Divot Pattern Easel, Double Sided, 22"x32" \$669
- S3181 Proper Divot Pattern Sign 18"x 12" with fin for surface mount \$130
- S3182 Proper Divot Pattern sign 18"x12" mounted on a 2"x2"x18" stake. \$130
- S3180 Proper Divot Pattern sign 18"x12" with 2 spikes. \$117



Custom Sponsor & Tee Signs for Golf Courses

Our custom sponsor and tee signs are a perfect way to enhance the professional appearance of your golf course while providing valuable information and recognition. These signs are highly versatile and can be fully customized to meet your specific needs.

- SP2501F Includes Tee Sign & Arm Style Post with Fluted and Chamfered Top. \$731
- SP2502 Includes Tee Sign & Arm Style Post with Chamfered Top. \$731
- SP2503 Includes Tee Sign & Side Mount Style Post with Chamfered Top. \$646
- SP2504 Includes Tee Sign & Extended Side Mount Style with Chamfered Top. \$706
- SP2505 Includes Tee Sign & Direct Face Mount Style with Chamfered Top. \$581
- Add a Sponsor Sign for an Additional \$129
- Add Your Hole Layout for an Additional \$234
- Vector Artwork is Required for Hole Layouts or Art Charge [per hole to redraw] \$195

Tee Signs

Tee signs are essential for providing players with critical information for each hole. Our custom signs can be designed to include:

- Hole Number & Name: Clearly display the hole number and any unique hole names
- Yardage & Par: Provide accurate yardage for different tee boxes and the par for the hole.
- Hole Layout: Feature a clear and concise diagram of the hole's layout, including hazards and key landmarks.

Sponsor Signs

Sponsor signs are an excellent way to recognize corporate partners and generate additional revenue. Our signs are custom made to prominently feature your sponsors' logos and messaging, whether for a tournament or an entire season. With a wide range of colors, fonts, and custom shapes, we can design signs that not only serve their purpose but also seamlessly match your course's aesthetic.



SP2501F



SP2502



SP2503



SP2504



SP2505

CUSTOMIZE & ADD YOUR OWN LOGO & MESSAGE!



PRICE MATCH GUARANTEE with Any Major Competitor



Tee Signs

SC400 Tee Signs

Our laminate plastic signs are made of multiple layers of contrasting colors. Virtually maintenance free and will not rot or delaminate. They will handle just about any abuse and are available in unlimited colors. Stock colors shown to the right. Tee Signs include logo, hole number, par and yardages. Hole layout additional. See page 47 for tee sign and post packages. See page 53 for tee sign and post packages.

SC400	Beveled Tee Sign, 18x24x1/2"	\$411
SC400HL	With Hole Layout 18x24x1/2"	\$634
SC410	Deluxe Tee Sign, 18x24x1/2"	\$411
SC410HL	With Hole Layout, 18x24x1/2"	\$634
SC420	Bell Curve Tee Sign, 18x24x1/2"	\$411
SC420HL	With Hole Layout, 18x24x1/2"	\$634
SC420JR	Junior Bell Curve Tee Sign, 9"x12"x1/2"	\$85
SC430	Arch Tee Sign, 18x24x1/2"	\$411
SC430HL	With Hole Layout, 18x24x1/2"	\$634

Mocha Brown	Nutmeg	Indigo	Charcoal Gray	Slate Gray
GREEN/WHITE LETTERS	WHITE/GREEN LETTERS	BLACK/WHITE LETTERS	WHITE/BLACK LETTERS	BLACK/RED LETTERS
BLACK/YELLOW LETTERS	YELLOW/BLACK LETTERS	TAN/GREEN LETTERS	BROWN/WHITE LETTERS	TAN/BROWN LETTERS
RED/WHITE LETTERS	WHITE/RED LETTERS	BLUE/WHITE LETTERS	WHITE/BLUE LETTERS	BROWN/TAN LETTERS



Posts

GS1536 - 4x4x36"	\$78
GS1548 - 4x4x48"	\$101
GS1560 - 4x4x60"	\$127
GS1572 - 4x4x72"	\$170



SC400



SC400



SC420

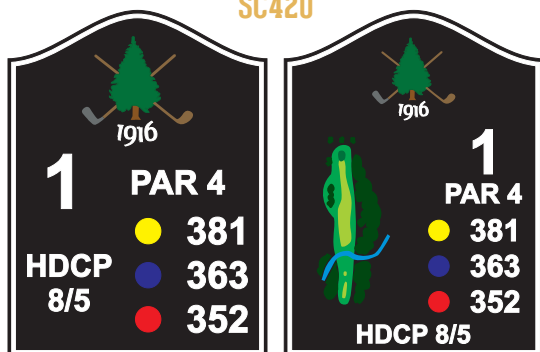

SC420



SC410



SC430



SC440



SC420JR



CUSTOMIZE & ADD YOUR OWN LOGO & MESSAGE!



RANGE / PRACTICE AREA

PRICE MATCH GUARANTEE *with Any Major Competitor*

Custom Range Signs

GSD100

Our custom driving range signs are essential for providing clear, professional communication and enhancing the golfer's practice experience. These signs can be tailored to meet the specific needs of your facility and are built to withstand the rigors of an outdoor environment. Choose from a wide range of backer colors, fonts, and graphics to create a custom sign that perfectly matches your course's unique aesthetic.

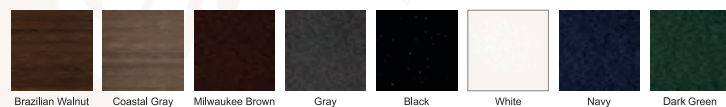
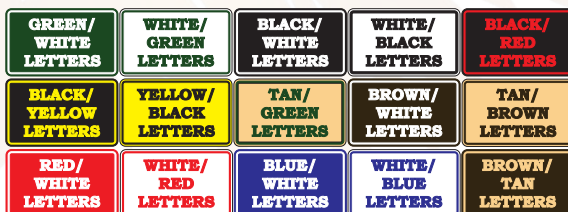
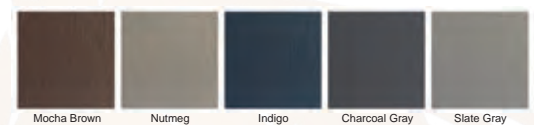

- GSD120** Today's Course Rules Range Sign with 18" Clock, 26"x34" on [2] 4"x4"x84" Posts **\$950**
- GSD105** Today's Course Rules Range Sign with 18" Clock and Logo, 28"x48" on [2] 4"x4"x84" Posts **\$1,530**
- GSD105** Large Range Sign with 15" Clock and Logo, 42"x72" on [2] 4"x4"x84" Posts **\$2,495**
- GSD115** Large Range Sign with 18" Clock and Logo, 36"x66" on [2] 4"x4"x84" Posts **\$2,300**
- GSD125** Large Range Sign with 18" Clock and Logo, 40"x60" on [2] 4"x4"x84" Posts **\$2,395**



GSD105



GSD120

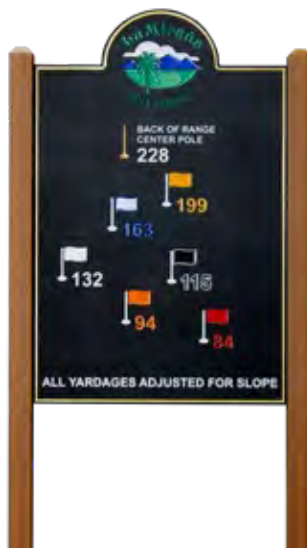

GSD125



GSD115



GSD110

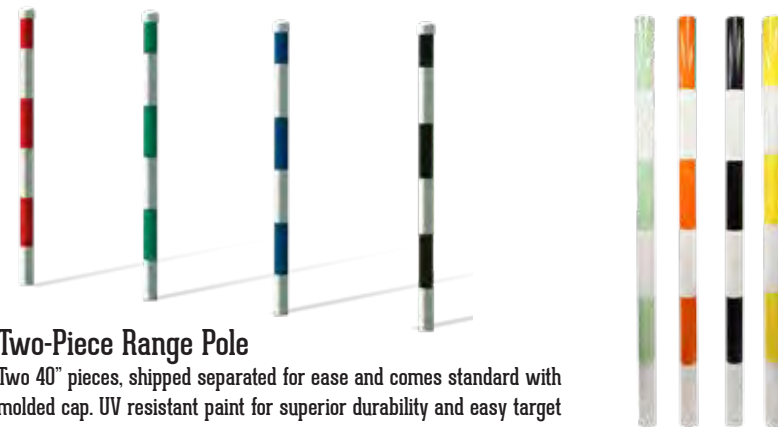

Two-Piece Range Pole

Two 40" pieces, shipped separated for ease and comes standard with molded cap. UV resistant paint for superior durability and easy target acquisition. Molded flag top sold separately.

- STD09610** Solid White **\$160**
- STD09620** Orange/White **\$182**
- STD09630** Yellow/White **\$182**
- STD09640** Red/White/Blue **\$182**
- STD09650** Black/White **\$182**
- STD09660** Blue/White **\$182**
- STD09670** Green/White **\$182**
- STD09680** Red/White **\$182**

Aluminum Driving Range Barber Pole

Powder coated Aluminum barber poles are made from 1/8" thick diameter aluminum and powder coated to provide a more durable finish compared to traditional paint. They come in two sizes to provide the best option for your range. Custom Colors Available

- GSD3000** 1/8" Thick x 4" Diameter x 96" Long **\$595**
- GSD3100** 1/8" Thick x 6" Diameter x 96" Long **\$749**
- GSD3025** 4" Dia x 18" Long PVC Sleeve **\$35**
- GSD3125** 6" Dia. x 18" Long PVC Sleeve **\$45**



Nylon Range Banner

Yellow/Black or Green/White, Vertical or Horizontal. Numbers 50 through 300 available.

Distance	Yellow/Black		Green/White	
	Horizontal	Vertical	Horizontal	Vertical
50 Yards	STD31050H	STD31050V	STD35050H	STD35050V
75 Yards	STD31075H	STD31075V	STD35075H	STD35075V
100 Yards	STD31100H	STD31100V	STD35100H	STD35100V
125 Yards	STD31125H	STD31125V	STD35125H	STD35125V
150 Yards	STD31150H	STD31150V	STD35150H	STD35150V
175 Yards	STD31175H	STD31175V	STD35175H	STD35175V
200 Yards	STD31200H	STD31200V	STD35200H	STD35200V
225 Yards	STD31225H	STD31225V	STD35225H	STD35225V
250 Yards	STD31250H	STD31250V	STD35250H	STD35250V
275 Yards	STD31275H	STD31275V	STD35275H	STD35275V
300 Yards	STD31300H	STD31300V	STD35300H	STD35300V
	\$60	\$60	\$60	\$60

Molded Flag Tops

Enhance the look of your driving range. Fits securely on top of our Range Marking Poles [sold separately]

- STD09615** White Flag **\$36**
- STD09625** Orange Flag **\$36**
- STD09635** Yellow Flag **\$36**
- STD09645** USA Flag **\$36**
- STD09655** Black Flag **\$36**
- STD09665** Medium Blue Flag **\$36**
- STD09675** Green Flag **\$36**
- STD09685** Red Flag **\$36**
- STD09651** Molded Flag Stick Only **\$25**
- STD09797** Molded Cap Only **\$11**

Range Banner Frame Kit

Sold Separately

STD31000 \$164 each kit

RANGE PRACTICE AREA



RANGE / PRACTICE AREA

PRICE MATCH GUARANTEE *with Any Major Competitor*

Golf Range Targets

Introducing the All New JFM Driving Range Distance Markers

Elevate your range with our durable and eye catching distance markers, crafted from hard laminated plastic lumber for long lasting performance. Available in a variety of colors and yardages to match your facility's needs. Our laminated folding target signs are an excellent addition to any driving range or golf practice facility

What truly sets these targets apart is their folding design, which allows for quick and easy setup, take down, and compact storage. This makes them ideal for temporary practice setups, tournaments, or for courses that need to move their targets frequently.

Custom Sizes to Fit Every Course

- Available in sizes from 24" x 24" to 48" x 96"
- From short wedge practice to long range bombs, we've got the right size for every shot

Personalized for Your Brand

- Add your course or sponsor logo for brand visibility
- Choose the classic bullseye or customize with specific yardages for training clarity

Built to Perform on the Range

- Angled for maximum visibility and to create a loud, satisfying "thud" when struck
- Instant feedback keeps golfers engaged and returning for more

Eye-Catching and Durable

- Available in a variety of bold, weather resistant colors that stand out
- Made to withstand heavy use and all conditions

Why They're Perfect for Your Range

- Elevate the training value of your facility
- Encourage golfers to improve distance control and shot accuracy
- Add a fun and competitive element that keeps players coming back
- Make your range look more professional and visually appealing



GM180-48 \$356

Engraved, laminate plastic 10"x48" sign mounted on an 8' Steel U-Channel Post
Custom colors and numbers available.

GM180-48NP \$120

Sign Only, post sold separately.

GM130 \$140

Engraved laminate plastic 31"x24" sign. Custom colors and numbers available. Posts sold separately.

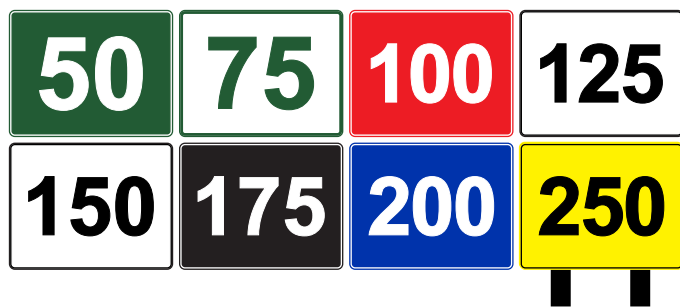

RANGE PRACTICE AREA

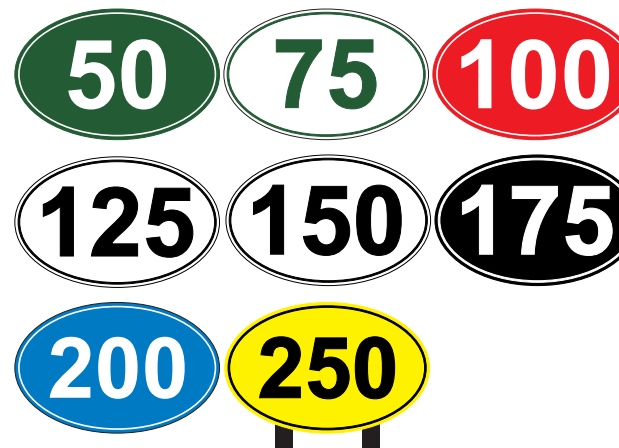

GM170 \$685

Engraved, laminate plastic 48"x30" sign mounted on two 2"x4" posts
Custom colors and numbers available

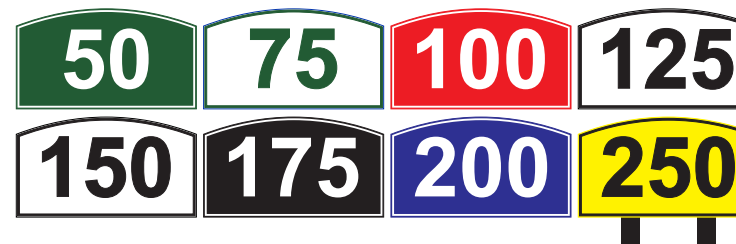

GM135 \$170

Engraved laminate plastic 31"x24" sign. Custom colors and numbers available. Posts sold separately.



GM140 \$249

Engraved, laminate plastic 24"x24" sign mounted on two 2"x4" posts
Custom colors and numbers available

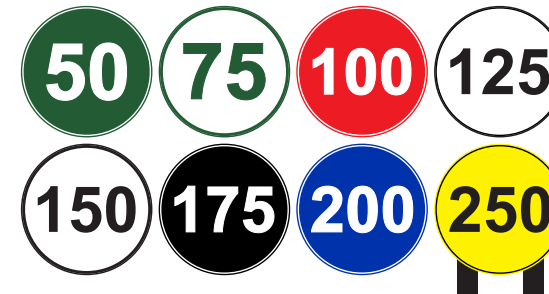

GM145 \$249

Engraved, laminate plastic 24"x24" sign mounted on two 2"x4" posts
Custom colors and numbers available



Have questions or ready to place your order?

Call us today — we're here to help!



RANGE / PRACTICE AREA

PRICE MATCH GUARANTEE with Any Major Competitor

Golf Range Targets

Introducing the All New JFM Golf Range Targets

Add excitement, precision, and professionalism to your range with JFM Golf Range Targets. Designed to create a more engaging practice experience, these targets help golfers train with purpose while giving your facility a sharp, upgraded look. Whether you're running a high performance facility or a casual practice area, JFM Range Targets bring style, function, and fun to your tee line.



GM150-24 \$279

These fixed range targets feature a 24" diameter face for clear visibility and are engraved with your custom logo. Choose from many styles & color schemes.

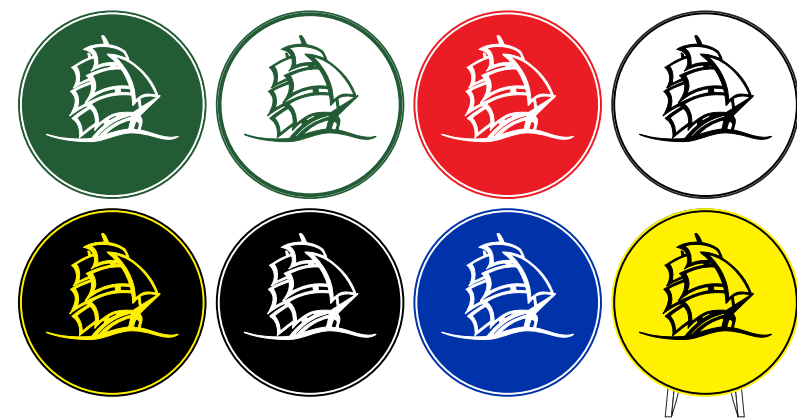

GM150-48 \$895

Our larger custom fixed range targets feature a 48" diameter face for extra visibility and are engraved with your custom logo. Choose from many styles & color schemes.



RANGE PRACTICE AREA

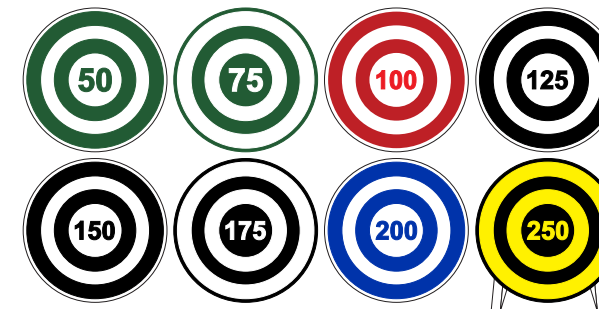

GM155 \$299

These fixed range targets feature a 24" diameter face for clear visibility and are engraved with your custom logo. Choose from many styles & color schemes.



S3524 \$299

Folding range targets feature a 24" diameter and are angled at 45 degrees for maximum visibility. Choose from many styles & color schemes

S3548 \$895

The larger version of our folding range targets features a 48" diameter and angled at 45 degrees for maximum visibility. Choose from many styles & color schemes

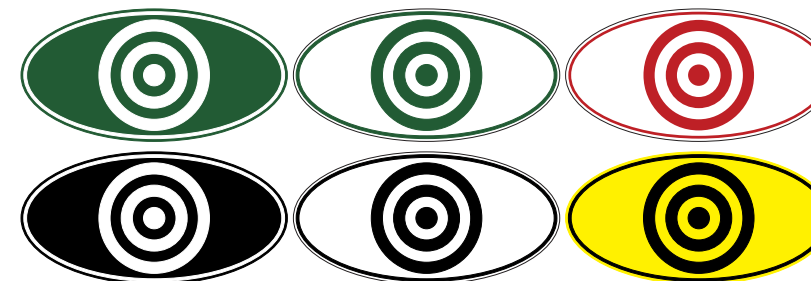

S3500 \$472

Folding range targets are 47"x32" and are angled at 45 degrees for maximum visibility. Choose from many styles & color schemes

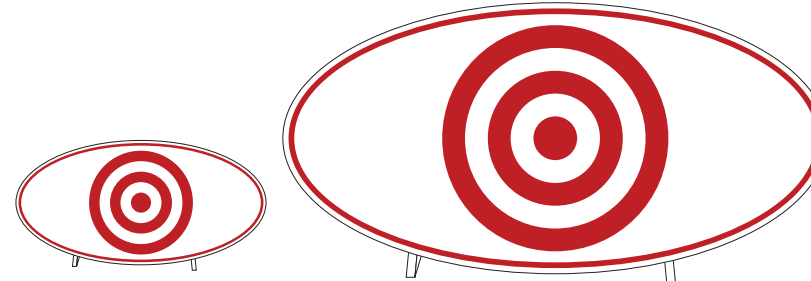

S3598 \$1,595

The largest version of our folding range targets measure 96" x 48" and angled at 45 degrees for maximum visibility. Choose from many styles & color schemes



Contact us today to place your order or ask about custom options!



RANGE / PRACTICE AREA

PRICE MATCH GUARANTEE with Any Major Competitor

RANGE DIVIDERS & BALL CRATES

- GRD100** This divider measures 2"x4"x42", lays flat and includes 3 spikes to hold it in place **\$67**
- GRD101** This divider is a 2"x4"x42" that sits on edge vertically and includes 3 spikes. **\$67**
- GRD102** This divider has a 2" x 4"x48" base with a 6" divider fin that has a cutout handle. You can also add your own logo. **\$147**
- GRD103** This divider is the same as are GRD102, but features a foot pad on each end. **\$177**
- GRD104** Logo Arch Divider has a 2"x4"x48" base with 8" arch top to add your course logo to. Single or double-sided. **\$243**
- GRD105** Logo Arch Divider. Same as GRD104, but it sits on top of a foot pad on each end. Single or double sided, and you can add your logo. **\$274**
- GRD110** Deluxe Arched Divider. This is our tallest divider that gives the golfer a little extra protection and looks great doing it. It's 48" long with foot pads on each end and is 12" high. Your logo can be added to single or double-sided models. **\$293**
- GRD111** Keystone Range Divider with new design. Single or double sided, and you can add your logo. **\$237**
- GRD115** Tribute Collection Range Divider. 48"L x 3.5"W x 7.5"H **\$313**
- JF-RS-301B** Hand fabricated from steel and has sturdy feet with bolt holes to safely anchor to surface. 31"x61"x9" at its highest peak and 18"x61"x9" at the lowest point. **\$499**



Metal Tee Divider

Sloped tee divider with powder coated finish. Can be mounted on grass on cement. 1" tubular steel with expanded metal mesh 54" L x 34" H.

- EP-TD-RW1** Green **\$369.95**
- EP-TD-003** Optional Green Bag Stand **\$74.95**
- EP-TD-RW1B** Black **\$369.95**
- EP-TD-003B** Optional Black Bag Stand **\$74.95**



JF-RS-301B



GRD110



GRD101



GRD103



GRD105



GRD115



GRD100



GRD102



GRD104



GRD111



RANGE PRACTICE AREA



Range Ball Baskets

Upgrade your driving range with our Ball Crate Dispensers, the ideal replacement for outdated ball trays. These dispensers are the perfect height to sit right at the edge of the mat or on the turf, providing easy access for golfers. Designed for convenience, they feature a powder coated aluminum gate that holds balls securely in place, dispensing just a few at a time for controlled use. The dispensers are available in three sizes, holding between 150 and 350 balls, to meet the needs of any practice facility. To impress your guests and add a professional touch, you can add your course's logo to the dispenser.

- GB100** Holds up to 150 balls, 12"L x 11"W x 8"H **\$236**
- GB200** Holds up to 250 balls, 23"L x 10"W x 9"H **\$290**
- GB300** Holds up to 350 balls, 21"L x 16"W x 9"H **\$324**
- GB225** Tribute Collection Range Ball Crate Hold Up To 250 Balls 23"W x 12"D x 12"H **\$394**
- GB100TD** Replacement Slide **\$26**



GB225



CUSTOMIZE & ADD YOUR OWN MESSAGE & LOGO!
Ask About Our Range Packages

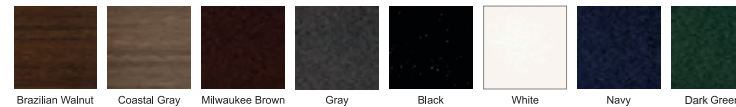



BAG STANDS



RANGE PRACTICE AREA

Folding Bag Stand
Folding Bag Stand constructed with 2"x2" frame. Folds for easy storage and stacking. 16"L x 7"W x 29"H
GBR100 \$173



Folding Bag Stand w/ Cup Holder
By far our most popular Folding Bag Stand. It includes one cup holder and can be configured with options like alignment stick holes or club rest notches. 19"L x 21"W x 28"H
GBR108 \$191
GBR-AL2 - Set of 2 Industry Leading Alignment Sticks \$49.95



Folding Bag Stand w/ Cup Holder & Logo
Same as our regular GBR108, but with your logo. We offer many different options for logo backing plates, and depending on your logo, we can engrave, inlay or add a bronze plaque. Call for details.
19"L x 21"W x 28"H
GBR108C \$294



Single Post Bag Stand
Single Post Bag Stand anchored with steel spikes. 14"L x 16"W x 28"H
GBR105 \$142



Folding Bag Stand
One of our most popular Bag Stands and folds for easy storage. 16"L x 21"W x 28"H
GBR107 \$175



Folding Bag Stand w/ Logo
Bag Stand with logo. Give us a call and let us customize one for you! 16"L x 21"W x 28"H
GBR107C \$264



Folding Bag Stand w/ 2 Cup Holders
Folding Bag Stand includes 2 cup holders. This can be configured with options like alignment stick holes or club rest notches.
24"L x 21"W x 28"H
16"L x 21"W x 28"H
GBR109 \$214



Folding Bag Stand w/ 2 Cup Holders & Logo
Folding Bag Stand includes 2 cup holders and a custom logo. This can be configured with options like alignment stick holes or club rest notches.
24"L x 21"W x 28"H
GBR109C \$308



CUSTOMIZE & ADD YOUR OWN MESSAGE & LOGO!

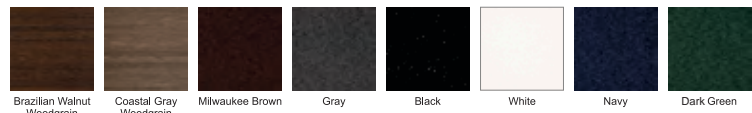



RANGE / PRACTICE AREA

PRICE MATCH GUARANTEE *with Any Major Competitor*

BAG STANDS



Recycled Plastic American Flag Golf Bag Stand

Show your patriotic spirit with our American Flag engraved bag stand with one cup holder. Folds for easy storage. 19"L x 21"W x 28"H

- GBR125 Without Cup Holder \$225
- GBR125-1 With One Cup Holder \$237
- GBR125-2 With Two Cup Holders \$255



Bag Stand

Stackable bag stands with a durable powder coated green finish. Sold in multiples of two. 26"L x 14"W x 25"H

STD36825 \$218



Single Bag Stand

Deluxe Bag Stand Heavy duty 2" x 4" construction holds one bag and includes two cup holders.

16"L x 20"W x 30"H

GBR139 \$359



Folding Bag Stand

16"L x 21"W x 28"H

- GBR112 Our exclusive Bag Stand folds for easy storage and has a stylish top \$209
- GBR112-1 Our exclusive Bag Stand folds for easy storage with one cup holder \$225
- GBR112-2 Our exclusive Bag Stand folds for easy storage with two cup holders. \$245



RANGE PRACTICE AREA



Folding Bag Stand

This design includes one cup holder and features club rest notches. Included is the stylish routed backing plate which can be plain or with your logo.

19"L x 21"W x 28"H

GBR110 \$280



Tribute Collection Folding Bag Stand w/ Cup Holder

This Lightweight Stand Is Easy To Move Around And Can Be Folded For Convenient Storage. It Is Perfect For Keeping Golfers' Bags Organized And Accessible During Practice. Customizable In A Variety Of Color Combinations.

19"L x 21"W x 28"H

- GBR115-0 Single Bag Stand no cup holder \$299
- GBR115-1 Single Bag Stand with Cup Holder with cup holder \$308
- GBR115-2 Single Bag Stand with 2 Cup Holders \$328



CUSTOMIZE & ADD YOUR OWN MESSAGE & LOGO!

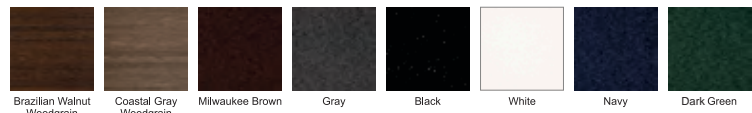



RANGE / PRACTICE AREA

PRICE MATCH GUARANTEE *with Any Major Competitor*

CLUB WASHERS



Pro Series Round Club Washer
Pro Series Round Club Washer. Rotomolded round container with a plastic lumber lid that is tough and durable. High quality internal brush unit scrubs clubs clean. 18" tall x 17" wide. Can be ordered in custom colors at no extra cost.

- GCW500 Complete Club Washer \$518
- GCW501 Container only \$279
- GCW502 Replacement lid \$79



GCWB \$28
Replacement Scrub Brush



Club Washer
Round Slatted Club Washer. Plastic lumber slats and lid for long lasting good looks. Incorporates an internal brush assembly that gets clubs clean.
18"L x 18"W x 19"H
GCW110 \$902



Club Washer w/ Hand brush
This washer houses a 5 gallon liner and has a club rest area to support the club while using the scrub brush on lanyard.
18"L x 18"W x 31"H
GCW100-1 \$641



Raised Club Washer w/ Brush
Slatted raised container houses a 5 gallon liner with lid and scrub brush on a lanyard.
15"L x 15"W x 32"H
GCW101 \$582

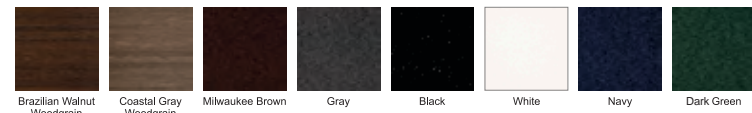

RANGE PRACTICE AREA



Ace Series Square Club Washer
Square rotomolded container with internal brush assembly and lid. 16"W x 16"L x 20"H
GCW400 Complete Club Washer \$518
GCW401 Container only \$279
GCW402 Replacement lid \$79
GCW403 Liner Only \$108



Square Club Washer Enclosure
Square Club Washer. Made from our rugged plastic lumber, it features a sturdy internal brush assembly. Ask us about adding your logo! 19"L x 19"W x 23"H
GCW120 \$1,019



Plastic Club Washer
Century Series Club Washer. Solid plastic lumber panels with 2"x2" frame and decorative arch. Houses internal brush assembly. Can be ordered in many colors and logo options. 19"L x 19"W x 23"H
GCW150 \$1,144

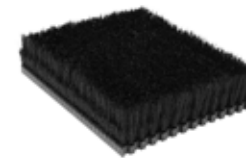

Replacement Brush
Replacement club washer internal brush. 9" x 12"
GCW355 Single Replacement Brush \$119
GCW350 Set of 2 Replacement Brushes \$238



Square Club Washer
Removable lid covers a 5 gallon liner with a club support and handy scrub brush on lanyard. 18"L x 18"W x 34"H
GCW105 \$547



Raised Club Washer with Towel Racks
This elevated club washer features two internal brushes for efficient cleaning, along with convenient side racks for hanging towels.
GCW160 \$1,195



CUSTOMIZE & ADD YOUR OWN MESSAGE & LOGO!





RANGE / PRACTICE AREA

PRICE MATCH GUARANTEE *with Any Major Competitor*

PICKERS / PARTS & ACCESSORIES



3 Gang High Rise Range Ball Picker
9 feet wide with a 1,350 ball capacity. Lightweight and solid wheel. Discs are the strongest and longest lasting on the market. Expandable to 5 or 7 gang.

EP-028AH \$3,795



5 Gang High Rise Range Ball Picker
15 ft. wide picker has a 2250 ball capacity. Discs are the strongest and longest lasting on the market. Lightweight and expandable to 7 gangs.

EP-029AH \$4,995



1 Gang Ball Picker
One gang picker with wheel and 2 split baskets.

EP-043A \$975



Replacement Picker Baskets
High back split basket with built in handles and holds approximately 250 balls.

19"L x 12"H x 10"W
EP-020AX \$94.95



EZ-Go Golf Cart Adapter
EZ-Go Golf Workhorse Adapter 2000-2017 3 bolt & MPT1200G, Cushman 800/1200

More adapters available on our website or contact us for more information.

EP-013F \$550



Replacement Discs

Complete Disc set consists of 21 discs assembled with rods and bushings.

EP-200 Black Disk Set **\$375**
EP-201 White Disk Set **\$395**

Individual replacement discs are unlike other pickers, state-of-the-art composite discs can be replaced separately.

EP-019AA Individual Black Disc **\$19.95**
EP-019END Individual Black End Disc **\$21.95**
EP-019W Individual White Disc **\$20.95**
EP-019ENDW Individual White End Disc **\$22.95**

3 to 5 Gang Expansion Kit

EP-035AH \$1,995

5 to 7 Gang Expansion Kit

Transform your picker as your needs grow.

EP-036AH \$1,995



RANGE PRACTICE AREA



22k Capacity Ball Washer
Stainless steel and aluminum construction cleans 22,000 balls per hour. Dual brush cleaning. Flow through hopper. Adjustable drain. High pressure water cleaning system. 38"L x 18"W x 39"H

BW-001N \$3,795



13k Range Ball Dispenser
6,500 or 13,000 ball capacities minimize refilling throughout the day. Quiet electric dispenser. Adjustable ball drop. Rust resistant. Variety of token and wireless electronic options. Price includes one token mechanism of choice.

BD-001 Electric 13,000 Ball Capacity 37" W x 40" D x 71" H **\$7,695**
BD-002 Manual 13,000 Ball Capacity 37" W x 40" D x 71" H **\$7,295**
BD-003 Electric 6,500 Ball Capacity 37" W x 41" D x 56" H **\$7,295**
BD-004 Manual 6,500 Ball Capacity 37" W x 41" D x 56" H **\$6,895**
RE-002 Range- Express Gold Package, Call for Details **\$4,495**
RE-003 Range-Express Platinum Package, Call for Details **\$6,495**
RE-011M PCI Compliant Credit Cards Package to Accept Cards at Dispenser **\$1,695**
RE-TS-IT Installation Fee w/ 1 Year Tech Support (45 Days Included with Purchase) **\$499**



Sparkleen Ecomax Detergent Tablets

STD03100 450 count jar. **\$114**

Sparkleen Liquid Detergent

STD03300 Case of 4 gallons **\$75**



Ball Boxes

Our Most Popular Ball Box with Just the Right Amount of Storage Space. Has 2x2 Construction and Feet to Keep the Box off the Ground.

GD1110 \$1,044



Large Capacity Ball Box with a Sloped Lid and Heavy Duty Hinges. Features 2x2 Construction and Feet to Keep the Box off the Ground. 36"L x 36"W x 33"H

GD1120 \$1,347



Slatted Ball Box

Built to handle the demands of the range, this sturdy box holds up to 5,000 golf balls. Designed with a vented bottom, it allows water to drain easily, helping balls dry out when needed. The GB1850 also features hinged lids with secure locking clasps for added protection and convenience.

Measures 39"L x 28"W x 27"H

GB1850 \$995



Brazilian Walnut Woodgrain Coastal Gray Woodgrain Milwaukee Brown Gray Black White Navy Dark Green



Call Today! 909-902-1012



RANGE / PRACTICE AREA

PRICE MATCH GUARANTEE *with Any Major Competitor*



BALL BASKETS & STACKERS

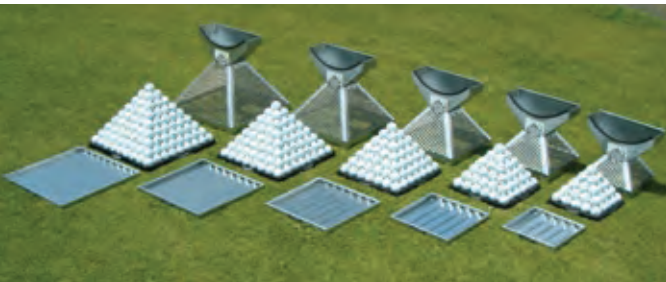

Metal Pyramid Trays

Simply place the Pyramid filler over a Pyramid tray and pour for a perfectly formed pyramid.

- PT55 55 Ball Metal Tray \$30
- PT91 91 Ball Metal Tray \$32
- PT140 140 Ball Metal Tray \$37
- PT204 204 Ball Metal Tray \$43
- PT285 285 Ball Metal Tray \$49

Economy Pyramid Stacker

- ST-106 55 Ball Pyramid \$119.95
- ST-100 91 Ball Pyramid \$139
- ST-101 140 Ball Pyramid \$149.95
- ST-102 204 Ball Pyramid \$159.95
- ST-107 285 Ball Pyramid \$169.95
- ST-108 55 Ball Metal Tray \$25
- ST-103 91 Ball Metal Tray \$29
- ST-104 140 Ball Metal Tray \$33
- ST-105 204 Ball Metal Tray \$35
- ST-109 285 Ball Metal Tray \$38



Range Ball Pusher

Make short work of your practice area cleanup.

STD85300 \$92



Original Bag Shag

The Bag Shag allows for quick and easy ball pickup without bending over. Constructed of durable PVC with a heavy duty zipper and a comfortable grip metal handle. Measures 33" long.

- BS-002A Green \$55
- BS-002D Black \$55
- BS-002E Dark Blue \$55
- BS-002F Red \$55



Bag Shag Holder

This durable Bag Shag Holder is designed to keep your driving range organized and your shag bag easily accessible. It's built to hold two shag bags and measures Also available with up to 10 positions. 31" W x 14" D x 31" T.

GBS-001 Holds 2 Bags \$439



Fore-n-One Stacker

Make all four sizes with the large stacker and two small sizes with the smaller stacker. Stacker and trays made from high impact plastic.

- ST-066 Small Stacker makes 55, 91 pyramids \$199
- ST-084 Large Stacker makes 55, 91, 140, 204 pyramids \$219
- ST-007 55 Plastic Ball Tray \$22
- ST-008 91 Plastic Ball Tray \$25
- ST-009 140 Plastic Ball Tray \$28
- ST-012 204 Plastic Ball Tray \$31



RANGE PRACTICE AREA

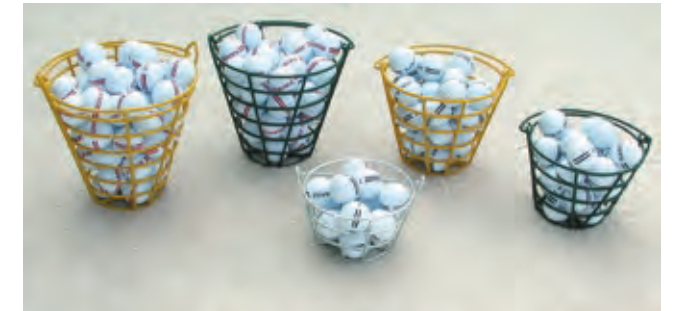
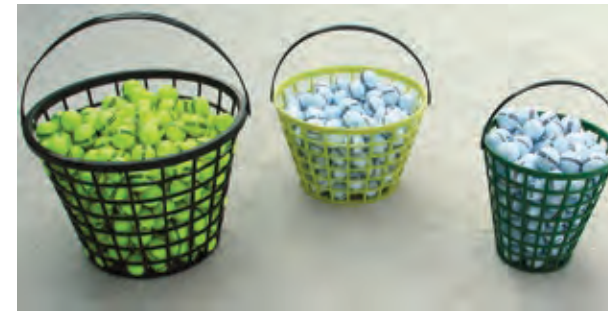

Plastic Range Ball Baskets

Made from unbreakable nylon plastic with handles that won't bend or crack. Available in Green [A], Yellow [Y], Natural [C], Black [D]

- BB-013 A/B/C/D 25-30 Ball Capacity [5 ring-5"H] \$9.75
- BB-012 A/B/C/D 40-45 Ball Capacity [5 ring-5"H] \$10.75
- BB-011 A/B/C/D 70-75 Ball Capacity [5 ring-5"H] \$11.75
- BB-010 A/B/C/D 100-105 Ball Capacity [5 ring-5"H] \$12.75
- BB-017 A/B/C/D 145-155 Ball Capacity [5 ring-5"H] \$26.75
- BB-018 A/B/C/D 300-325 Ball Capacity [5 ring-5"H] \$29.75



BS001 \$199

Range Ball Basket Stacker

This unit is designed to hold three stacks of golf ball baskets, keeping them neatly organized and off the ground.

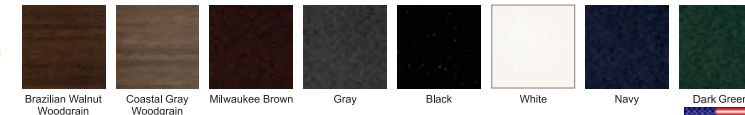



RANGE MATS & TARGETS



Rubber Tees

- RT-001A 1 ¼" Rubber Tee \$1.50
- RT-001B 2" Rubber Tee \$1.50
- RT-001C 2 ¼" Rubber Tee \$1.50
- RT-001D 2 ½" Rubber Tee \$1.50
- RT-001E 2 ¾" Rubber Tee \$1.50
- RT-001F 1" Rubber Tee \$1.50
- RT-001G 3 ½" Rubber Tee \$1.50



Tee Holders

- RT-ATH122 1" Tee Holder \$1.75
- RT-ATH200 2" Tee Holder \$1.75



RANGE PRACTICE AREA

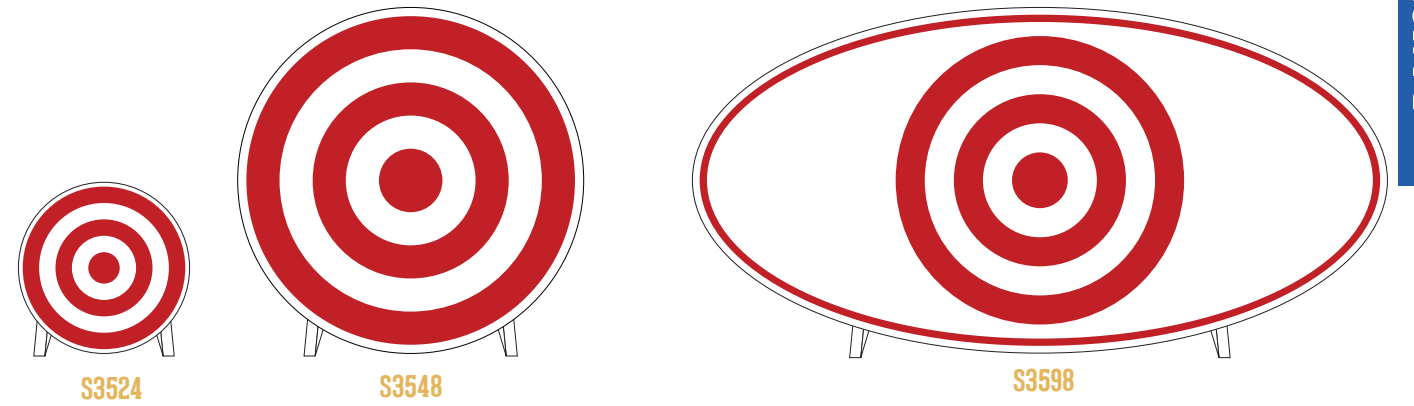

S3524

S3548

S3598

Fixed Range Targets

Our fixed driving range targets are a highly visible and durable solution for any practice facility. Designed to be easy to spot, they provide a clear point of aim for golfers to help them improve their accuracy. You can choose from many styles and color schemes to perfectly match the aesthetic of your course.

- S3524 24" inch Diameter \$299



S3500

Folding Range Targets

Folding Range Targets are highly visible and fold at a 45 degree angle for maximum visibility. Easy to spot and provides a clear point of aim for golfers. Choose from Many style & Color Schemes

- S3500 Measures 47"x32" \$472
- S3548 48" inch Diameter \$895
- S3598 Measures 96"x48" \$1,595



Plastic Ball Tray

This range ball tray is UV stable and has drain holes to eliminate water build up. Holds 90 range balls.

- BT-002A Forest Green \$59.95
- BT-002B Black \$59.95



Swing Training Mat

Lines permanently embedded in the mat aid in teaching the correct swing and stance. Set into a 1/8" liquid poured urethane based and constructed from 1/2" Nylon Sports Turf with a 3/4" Foam Pad.

- MT-339 \$409.95



Standard Green 4-hole Square Mat

Three layer construction driving range mat. Constructed from 1/2" knitted nylon. Urethane base.

- Weight - 35 lbs. 59" x 59"
- MT-331 \$379.95



Dual Blend Driving range Mat

4-Hole Square 59"x59" Dual Blend combines two turf heights to reduce club head resistance and provide a more realistic hitting surface. Has an NBR/PCA closed cell 3/4" foam pad and a polyurethane liquid poured bonding process.

- MT-400 - Forest Green \$419.95



True to Turf Mat

Extremely realistic "feel" imitates natural turf. Without bounce or resistance of a normal mat.

- MT-475 \$489.95

Tee Targets

Perfect for your range. Give your customers target help with their short game. Sturdy Polybutylene frame with heavy duty UV protected nylon netting. The base is weighted for stability in the wind.

- TT-050 Tee Target, 3ft, black, 10 lbs. \$329
- TT-051 Tee Target Accent Pads (6 pads) \$50
- TT-100 Tee Target, 4ft, black, 22 lbs. \$375
- TT-101 Tee Target Accent Pads (6 pads) \$50
- TT-200 Tee Target, 6ft, black, 42 lbs. \$610
- TT-201 Tee Target Accent Pads (10 pads) \$70



TT-200

TT-100

TT-201

TT-050

TT-101

TT-051



BAG RACKS

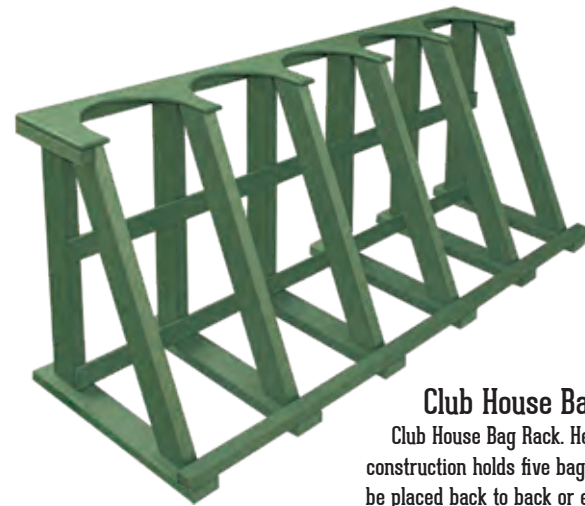

Club House Bag Racks
Club House Bag Rack. Heavy duty 2" x 4" construction holds five bags. These racks can be placed back to back or end to end for busy bag drop areas. 72"L x 32"W x 32"H

GBR140 \$995



Modular Bag Rack

This lightweight Modular Bag Rack is made from durable plastic lumber and can be ordered to hold three or five bags.

- GBR145-3** 3 Position, 46"L x 18"W x 36"H **\$490**
- GBR145-5** 5 Position, 73"L x 18"W x 36"H **\$931**



Deluxe Bag Rack

Made from durable plastic lumber like all our furnishings.

- GBR160-3** 3 Position, 46"L x 18"W x 36"H **\$839**
- GBR160-5** 5 Position, 73"L x 18"W x 36"H **\$1,103**
- GBR160-8** 8 Position wall mount, 112"L x 18"W x 36"H **\$1,713**



Portable Bag Rack

This Bag Rack can be custom ordered in several configurations. It can be single or double sided, portable as shown or without feet for permanent mount.

- GBR180** Permanent Mount Bag Rack. 72"L x 36"W x 60"H **\$560**
- GBR200** Portable Mount Bag Rack. 72"L x 36"W x 36"H **\$571**
- GBR200D** Portable Mount Bag Rack. Double Sided 72"L x 36"W x 36"H **\$937**



Bag Drop Station

This popular 5 bag drop station is made from sturdy 2x2 construction. This can be put end to end and back to back to increase your bag storage capacity. 74"L x 18"W x 32"H

GBR170 \$1,032



Tribute Collection Portable 5-Position Bag Station

The perfect addition to your pro shop or clubhouse! This bag rack offers convenient storage for up to five bags, making it ideal for any busy course. It can be ordered in either a portable or permanent mounting configuration and comes in a variety of color combinations to suit your style. 78"L X 13"W X 36"H

GBR225 \$1,207



CUSTOMIZE & ADD YOUR OWN MESSAGE & LOGO!

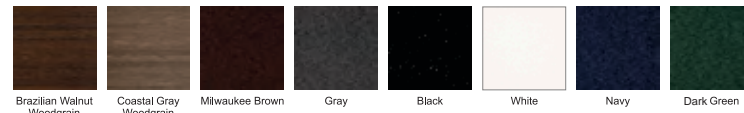



BAG RACKS



Club House Bag Rack

Our new 7 position bag rack is the perfect solution to keep your driving range and clubhouse organized. This durable rack holds up to six golf bags, preventing clutter and ensuring a tidy, professional appearance.

GBR175 \$2,179



Deluxe Bag Rack w/ Logo

Our favorite Imperial Bag Rack Holds 6 bags and includes your logo.

- GBR165-5C** Holds 5 bags. 74"L x 18"W x 46"H **\$1,908**
- GBR165-6C** Holds 6 bags. 90"L x 18"W x 46"H **\$2,077**
- GBR165-7C** Holds 7 bags. 106"L x 18"W x 46"H **\$2,340**
- GBR165-8C** Holds 8 bags. 122"L x 18"W x 46"H **\$2,598**



Deluxe Bag Rack

Our most popular bag rack is durable and can hold between 5-8 golf bags, preventing clutter and ensuring a tidy, professional appearance.

- GBR165-5** Holds 5 bags. 74"L x 18"W x 46"H **\$1,747**
- GBR165-6** Holds 6 bags. 90"L x 18"W x 46"H **\$1,916**
- GBR165-7** Holds 7 bags. 106"L x 18"W x 46"H **\$2,179**
- GBR165-8** Holds 8 bags. 122"L x 18"W x 46"H **\$2,437**



Bag Drop-Off Rack

Heavy duty painted steel. Easy to assemble. 71"L x 42"W x 37" H Available in green only. Single weight: 170 lbs. Double weight : 245 lbs.

- EP-BR6** Green Single Bag Drop Stand, holds 6 bags **\$1,149**
- EP-BR12** Green Double Bag Drop Stand, holds 12 bags **\$1,799**



Aluminum 12 Bag Drop-Off Rack

Our premium bag rack is constructed from rust free aluminum. A classic style makes this rack a great choice. Available in black only. Weight: 62 lbs

- BR-015** Black, 88"L x 27"W x 40"H **\$1,549**
- BR-021** Optional Caster Wheels **\$299**



CUSTOMIZE & ADD YOUR OWN MESSAGE & LOGO!

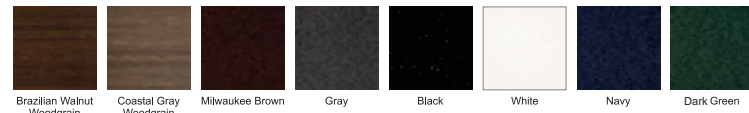



PODIUMS



Portable Podium
This small, basic podium can be used for special events. It has a hinged lid that opens for storage.

GP2010 \$612

Permanent mount podium on post.

GP2015 \$586

GPCASTER \$249



Deluxe Podium With Logo

Our popular GP1200 has a hinged sloped lid with storage underneath. On the back, you'll find two hinged doors that open for lots of storage with a shelf in the middle. 2"x2" frame construction finished off with trim top and bottom.

Add casters to finish it off. 32"L x 18"W x 46"H

GP1200 \$1,968
GP1200C With Logo \$2,085

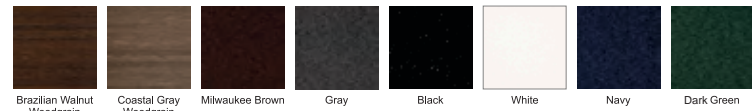

Tournament Podium

This podium is designed for both style and practicality. It features a hinged opening lid that reveals a storage area underneath, along with a handy pencil stop to keep things from rolling off the top.

The back of the podium is equipped with a hinged door that opens to reveal spacious storage shelves. For a personal touch, it can be fully customized, and you can choose from a wide range of color combinations to perfectly match your space.

30"L x 18"W x 41"H

GP1350 \$1,190
GP1350C \$1,295



Valet Podium

This new valet podium is the perfect solution for keeping your valet area organized and professional. It features a fixed, sloped lid with a pull out drawer for storage. On the back, two hinged doors provide access to a spacious storage area with a shelf in the middle. This is where you'll find the valet hooks and numbers neatly stored and ready for use. Constructed with a sturdy 2" x 2" frame and finished with trim at the top and bottom, this podium is built to last. You can also add casters to the base for easy mobility. 32"L x 18"W x 46"H

GP1500 \$2,730
GP1500VH Optional Valet Hooks for the GP1500 Podium \$350



CUSTOMIZE & ADD YOUR OWN MESSAGE & LOGO!



PODIUMS



Tribute Collection Flat Top Podium

The perfect addition to any golf course! This sleek podium includes two doors and shelves for optimal storage, making it both functional and stylish. Plus, it's fully customizable in any color combination to match your course's aesthetic and can be ordered with casters. Call today to place your order and enhance your course's look and functionality! 34"L x 21"W x 46"H

GP1525 \$2,620



Tribute Collection Angled Top Podium

This podium features a hinged lid, two shelves for storage, and can be ordered with casters for easy relocation. It's fully customizable in a variety of colors to perfectly match your course's appearance. Call today to place your order and elevate your tournament setup! 34"L x 21"W x 46"H

GP1375 \$2,257



Grand Podium

The Grand Podium looks great at the clubhouse. It has a flat top work area and three doors on the back that open up to plenty of space for the busiest clubs. It also has built-in shelves or extra storage, and can be ordered with the valet racks on the doors to keep keys organized. Add your logo and it will impress anyone.

63"L x 21"W x 47"H

GP1450 \$2,962
GP1450VH \$575
Valet Hooks for GP1450 Podium. Includes numbers and hooks for 90 sets of keys.



Optional Valet Hooks Shown



Mid-Size Podium

This podium is designed to elevate your course, combining a professional look with smart storage solutions. It features a split hinged opening lid that reveals a storage area underneath, along with a handy pencil stop to keep things from rolling off the top. A convenient umbrella hole is also included. The back of the podium is equipped with a hinged doors that opens to reveal spacious storage shelves. For a personal touch, this podium can be fully customized and you can choose from a wide range of color combinations to perfectly match your space. 39"L x 21"W x 46"H

GP1600 \$1,897



Clubhouse Podium

Full sized podium has hinged opening lid and doors with storage shelves. Pencil stop. Can be Customized. Many color combinations available. 63"L x 21"W x 47"H

GP1550 \$3,328



CUSTOMIZE & ADD YOUR OWN MESSAGE & LOGO!

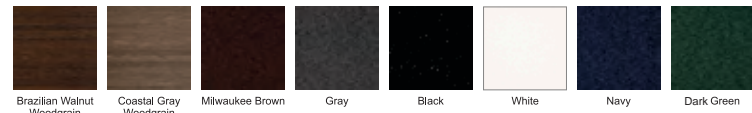



SCORE CARD CADDIES



Score Card Caddy

- GSC100** Scorecard Caddy on post. This caddy has a hinged lid that opens to three sectioned areas for scorecards, pencils and tees. Includes a 4"x4"x60" plastic lumber post. **\$435**
- GSC101** Scorecard Caddy only, no post. **\$203**
- GSC100P** Scorecard Caddy on post and base. Need to make it portable? This one is for you. **\$490**



Tribute Collection Score Card Caddy

The perfect way to keep your scorecards organized and accessible! This caddy features 3 separate compartments, a hinged lid, and a post for easy placement. For added versatility, it's also available with a portable base to suit your needs. Customizable in a variety of colors to match your course's look! Caddy top: 20"L x 15"W x 11"H permanent post is 4" square by 60" long portable unit stands 39" off the ground on a 30" square base.

- GSC125** Scorecard Permanent Mount Caddy **\$878**
- GSC125P** Scorecard Portable Mount Caddy **\$930**



Deluxe Table Top Score Card Caddy

This score card caddy has room for all your necessities. This can be customized to fit your needs. **GSC400 \$605**

Tabletop Score Card Caddy

Sits on a countertop or table and can be customized. **GSC120 \$440**



Exclusive Score Card Caddy

Are you looking for a scorecard caddy to keep everything clean and dry? Look no further. A JFM exclusive, this newly designed score card caddy has a smooth pullout drawer with four sections designed to keep water and dirt out. The housing is sealed, and the front features a magnetic closure to keep the face shut. Includes a 4"x 4"x 60" post. Add your logo to the front or top. **GSC500 \$1,284**



Score Card Center

Want to display your scorecards, pencils, tees and ball mark tools in a big way? This one has an open top and a hinged door on the back for lots of storage. It can be ordered with a removable or hinged lid. Add your logo to make it special. 24"L x 20"W x 40"H **GSC300 \$1,562**



Score Card Caddy/Trash Enclosure

This side load trash enclosure is the perfect solution for heavier traffic areas on the golf course. It features a convenient scorecard caddy on top, giving golfers a place to grab their scorecards and pencils. Inside, a 26 gallon liner provides ample capacity for trash. Add your logo to fully customize for your course. **GT2175 \$1,256**



CUSTOMIZE & ADD YOUR OWN MESSAGE & LOGO!



SHOE CLEANER STATIONS



CLUBHOUSE / TOURNAMENT

Angled Air Wand

20 inch.
GSCS115 \$50



Blue Recoil Hose

1/4" X 15 ft.
GSCS117 \$106



Small Shoe Cleaner Station

Aids golfers to clean shoes. Made to be used with compressed air to blow off dirt from shoes. Grass clippings and dirt fall through grate into a removable tray. Can be customized with logo. Includes air wand. Compressor & hose not included.

26"L x 21"W x 39"H
GSCS106 \$1,266

Sold separately. Air compressor housing to conceal our air compressor.
GSCS105 \$582



Tribute Collection Shoe Cleaner Station

A sleek and stylish addition to your pro shop or clubhouse that is sure to impress your golfers! This shoe cleaner features an air wand and a pull out drawer for easy removal of debris. 26"L x 21"W x 42"H

GSCS110 \$1,774

Century Shoe Cleaner

Beautifully routed, all plastic lumber construction panels are mounted on a sturdy 2"x2" frame. Grass is blown off the golfer's shoes and the debris falls through a grate into a pull out drawer below for easy cleaning. 26"L x 21"W x 42"H

GSCS108 \$1,328
GSCS109 Century Air Compressor Housing. \$782
Matches the shoe cleaner [not shown]. 30"L x 18"W x 41"H



Mid-Size Shoe Cleaner Station

Mid size shoe cleaner station

Aids golfers to clean shoes. Made to be used with compressed air to blow off dirt from shoes. Grass clippings and dirt fall through grate into a removable tray. Can be customized with logo or graphics fit to your needs. Includes air wand. Compressor & hose not included. 35"L x 22"W x 38"H

GSCS107 \$1,709



Air Compressor

Makita Big Bore, 2 hp
The only air compressor to fit our housings perfectly.
GSCS104 \$675



Scrusher

Three separate bottom brushes now with softer, long lasting nylon bristles to clean your shoes without scratching.

STD14100 \$115



Tribute Collection Air Compressor Housing

The perfect companion to our GSCS110 Tribute Collection Shoe Cleaner can be ordered in any combination of colors to perfectly match your club's aesthetic.

GSCS111 \$792



Duo-Kleener Stand

Anchors in ground or turf stakes. Brushes to clean bottom of shoes.
STD36650 \$395



Scrusher w/Tray

Tray collects the grass and dirt that is removed with the Scrusher.

Includes Scrusher and Tray.
GSCS120 \$287



Golf Spike Cleaner

This versatile spike cleaner features a tall, sturdy design with a backer and a base for stability. It's equipped with a sturdy stand that includes two brushes, which includes two brushes to effectively clean both golf spikes and clubs. The unit is designed for durability and is perfect for placement near the clubhouse or first tee. 26"L x 21"W x 33"H

GSCS160 \$1,325

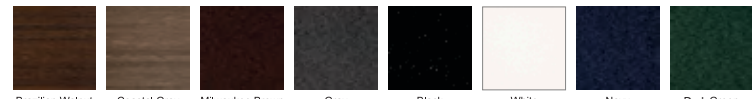



PRICE MATCH GUARANTEE *with Any Major Competitor*

SCORE BOARDS



Divot Repair Tool

Keep your greens in top condition with our durable divot repair tools, designed to quickly and cleanly fix ball marks. Available in your choice of single prong or two prong styles, each tool can be ordered plain or customized with your course or company logo.

DRT-01 - Rubber Handle, Min Order Quantity 250 Pieces, Prices Starting at \$0.75 Each

DRT-02 - 1 Prong Bent Metal, Min Order Quantity 250 Pieces, Prices Starting at \$0.53 Each

DRT-03 - Prong Metal Handle, Min Order Quantity 250 Pieces, Prices Starting at \$0.53 Each

Ball Markers

Keep your spot on the green with ease. Our durable golf ball markers are designed for convenience and style, helping players mark their ball placement with confidence during every round. Available in a wide range of vibrant colors, they can be ordered plain or customized with your logo making them ideal for personal use, golf shops, tournaments, or promotional giveaways. Choose from multiple options to match your style or branding. Add your logo for a professional, branded touch.

BM-01 - Call for Quote, Min Order Quantity 100 Pieces, Prices starting at \$0.65 each



BM-01

Driving Range Golf Balls - Single, 2 or 3-layer

Call for Quote - Price Subject to Change

Choose from single layer [most durable, budget friendly], 2 layer [better feel & flight], or 3 layer [premium spin & soft feel]. All models are built for range use and can be ordered with or without your logo.

RB100-01 - Single Layer, Call for Quote, Min Order Quantity 420 Dozen,

Prices starting at \$7.35/ Dozen

RB100-02 - 2 Layer Call for Quote, Min Order Quantity 420 Dozen,

Prices starting at \$8.25/ Dozen

RB100-03 - 3 Layer Call for Quote, Min Order Quantity 420 Dozen,

Prices starting at \$11.75/ Dozen



Custom Wooden Golf Tees

Showcase Your Brand

Price Subject to Change

Stock up on premium wooden tees perfect for the driving range or pro shop. Choose from multiple sizes and packaging options to fit your golfers' needs. Add your logo or course name for a lasting impression every time they tee it up.

PT-01 - Plastic Tees. Call for Quote, Min Order Quantity 10,000 tees,

Prices starting at \$0.04 each

WT-01 - Wooden Tees. Call for Quote, Min Order Quantity 10,000 tees,

Prices starting at \$0.04 each



PT-01



WT-01



CLUBHOUSE / TOURNAMENT

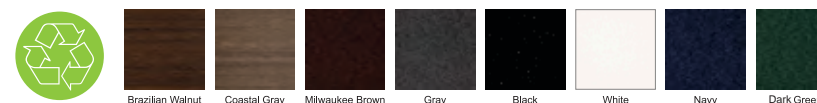

Score Boards

GSB100DE Score Board 48"x48" Double sided dry erase board **\$2,891**

GSB100CB Score Board 48"x48" Double sided cork board **\$3,391**

GSB100DECB Score board, 48"x48". Double sided with dry erase on one side, cork board on the other. **\$3,141**

GSB101DE Score Board, 48"x96". Double sided dry erase **\$4,299**

GSB101CB Score Board, 96"x48". Double sided cork board **\$4,799**

GSB101DECB Score board, 96"x48". Double sided with dry erase on one side and cork board on the other. **\$4,549**



Double Sided Cork Board

This 96" x 48" scoreboard is a durable and highly functional solution for your course. It's built with solid plastic lumber and reinforced for long lasting performance. The scoreboard is double sided with cork board on both sides, providing plenty of space to post information for players and spectators. Equipped with heavy-duty casters, it's easy to move on and off the course as needed. You can also add your logo to the top arch or the bottom panel.

GSB101CB



Dry Erase & Cork Board

Score Board 96"x48" Double sided with dry erase on one side and cork board on the reverse. Solid plastic lumber construction with plenty of reinforcement. A popular option with two options for relaying announcements. Comes with heavy duty casters to make moving the score board easy on and off the course. Add your logo to the top arch or the bottom panel.

GSB101DECB



Double Sided Dry Erase

This scoreboard is the perfect solution for your course, measuring a large 96" x 48". It's built from solid plastic lumber with ample reinforcement. Both sides of the scoreboard feature a dry erase board, giving you plenty of space to display important information. It comes equipped with heavy duty casters and can be personalized with your logo on the top arch or bottom panel to give it a custom, professional look.

GSB101DE



Double Sided Cork Board

The double sided cork board measures 48"x48" and gives you ample space to display event information for everyone to see. The Included heavy duty casters make moving this effortless. To complete the look, you can add your logo to the top arch or the bottom panel, making it a professional centerpiece for any tournament or outing.

GSB100CB



CASUAL FURNITURE

PRICE MATCH GUARANTEE *with Any Major Competitor*

BENCHES



Heritage Bench
Built with 2" x 4" construction and slatted seat back. Shipped fully assembled and can be customized with a logo or memorial message. Available in three sizes.

- GB1012-4 4' ft. Length \$1,127
- GB1012-5 5' ft. Length \$1,365
- GB1012-6 6' ft. Length \$1,419



GB1004



GB1406

High Back Bench

High Back Bench constructed with sturdy molded legs and 2"x4" slats. Ships knocked down and includes stainless steel hardware. Can be personalized with custom engraved slats and is offered in a variety of lengths.

- GB1004 4' ft. Length \$733
- GB1005 5' ft. Length \$919
- GB1006 6' ft. Length \$1,020
- GB1406 6' ft. Length \$1,116
- GB-MS Memorial Slat \$105



GB1005, GB1006

IN MEMORY OF RENATE

Memorial Slats are A Great Way to Honor Your Loved Ones

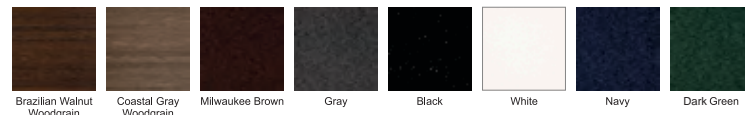

GB1104

GB1105, GB1006

Mall Bench

Mall Bench constructed with rugged molded legs and 2"x4" slats. Ships knocked down and includes stainless steel hardware.

- GB1104 4' ft. Length \$479
- GB1105 5' ft. Length \$596
- GB1106 6' ft. Length \$646



Classic Mall Bench

Classic Mall Bench built from 2"x4" A frame legs with 2"x4" slats. Available in two sizes.

- GB1304 4' ft. Length \$523
- GB1306 6' ft. Length \$773



Tribute Collection Mall Bench

Part of our premium Tribute Collection. Built with sturdy 4x4 legs and a contoured seat for exceptional comfort, this bench is designed to last and impress. It's the perfect addition to any serene spot on the range or anywhere throughout your course where golfers can relax and take in the view.

- GB1250 5' ft. Length \$1,038



Contoured Mall Bench

Contoured Mall Bench features a comfortable seat made with 4"x4" legs. 2"x4" frame. 1"x4" slats and decorative arch trim.

- GB1225 5' ft. Length \$775



Traditional Bench

Heavy Duty construction with 4"x4" legs and contoured slatted seating. Available in several sizes.

- GB1500 4' ft. Length \$652
- GB1500 5' ft. Length \$734
- GB1500 6' ft. Length \$827



CUSTOMIZE & ADD YOUR OWN MESSAGE & LOGO!





CASUAL FURNITURE

PRICE MATCH GUARANTEE *with Any Major Competitor*

CHAIRS & PICNIC TABLES



Traditional Contoured Adirondack Chair

The contoured seat and wide arms of this Adirondack chair is built for durability and the comfort of your guests. This ships fully assembled.

GAC105 \$599

Round Side Table

This round side table is made of recycled plastic and measures 18" round x 19" tall. Pair this table with your Adirondack chairs.

GAC106 - Round Side Table \$281



Double Contoured Adirondack Chair & Table

Our comfortable double Adirondack chair has a contoured seat and built in table. Made from heavy duty plastic lumber construction and ships fully assembled for your convenience.

GAC110 \$1,471



Rectangular Side Table

This side table is the perfect table to pair with your Adirondack chairs.

Made in recycled plastic and measures 18"L x 18"W x 19"H

GAC107 Rectangle Side Table \$356



GAC106

GAC105



Folding Adirondack Chair

Our folding Adirondack chair features the same comfortable, sloped seat and wide armrests as a traditional Adirondack, but with the added benefit of a folding design. This makes it easy to store in a compact space or transport for events, while its durable construction ensures it will last for years.

GAC125 \$734



Foot Stool

Relax and put your feet up while sitting in your Adirondack Chair.

GAC103 \$283

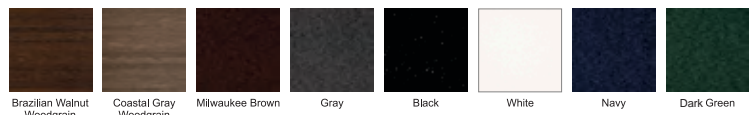

CASUAL FURNITURE



Standard 6 Foot Picnic Table

Standard 6 ft. long picnic table with 2" x 6" planks that make up the 29" wide top and comfortable 11" wide seats, with 4"x 6" corner leg posts for extra strength and durability. Ships knocked down to save on shipping. Instructions are included. Custom sizes available.

Tabletop - 72"L x 29"W x 31"H

Overall - 72"L x 60"W x 31"H

GB1700-6 \$1,761



Standard 8 Foot Picnic Table

Standard 8 ft. long picnic table crafted with our rugged plastic lumber throughout. The color is built and will never fade. Stainless steel hardware is included saving the worry about unsightly rust stains. Ships knocked down to save on shipping. Instructions are included. Custom sizes available.

Tabletop - 96"L x 29"W x 31"H

Overall - 96"L x 60"W x 31"H

GB1700-8 \$1,999



Hexagon Table

Hexagon picnic table. Solid, heavy duty plastic lumber construction available in a variety of colors. It ships knocked down to save on shipping and comes with hardware and instructions.

Tabletop - 46"L x 46"W x 31"H

Overall - 80"L x 80"W x 31"H

GB1900 \$1,715



CUSTOMIZE & ADD YOUR OWN MESSAGE & LOGO!





CASUAL FURNITURE

PRICE MATCH GUARANTEE *with Any Major Competitor*

DINING & LOUNGE SEATING



CASUAL FURNITURE



7-Piece Dining Table

Create a relaxing outdoor dining space with the Vineyard 7-Piece Dining Set. This all-weather dining set seats up to six and features comfortably arched chairs great for relaxing in long after dessert has been served.

CFD1200-6 \$5,471



Fire Pit & Adirondacks

Fire Pit with Adirondack Chairs. The fire pit can be propane or natural gas fed for warm comfort on cold nights. Round table with Fire Glass and a glass surround. Includes 4 chairs.

CFAF1004 \$6,211



Park Avenue Bench

6' ft. bench made from recycled plastic with a slatted seat and back.

CFB1206 \$924



Cafe Table & Chairs

Square Style Cafe Table and Chairs. Includes 4 slatted chairs.

CFD1500-4 \$3,332



Cafe Style Table and Chairs

Cafe Style Table and Chairs. All plastic lumber.

CFD1600-4 \$3,954
CFD1600-6 \$4,820



Beach Side Lounge Chair

CDLC101 Beach Side Lounge Chair, slatted with arm rests. **\$851**

CFLC102 Side Table **\$352**



The Cottage Collection

Designed for sun kissed celebrations and smaller families, this versatile all weather dining set is a welcoming scene for any alfresco occasion.

CFAD1212 Table & Chair Set **\$4,814**
CFAC1212 Each Chair Separately **\$832**



CUSTOMIZE & ADD YOUR OWN MESSAGE & LOGO!

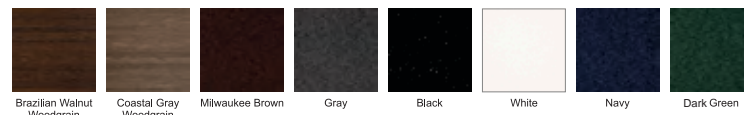



CASUAL FURNITURE

PRICE MATCH GUARANTEE *with Any Major Competitor*

DINING & LOUNGE SEATING



Country Living Legacy Rocking Chair Set

Upgrade your front porch with the Country Living Legacy Rocking Chair 3-Piece Set.
CFCL1200 \$1,400



Country Living 5-Piece Dining Table with Benches

Few things are better than a beautiful meal served outside. Set the scene for more of them with this all-weather set that brings open-air dining to your backyard.
CFCL1800 \$4,949



Lakeside 6-Piece Farmhouse Dining Set with Bench

Channel the ease of waterfront living with this weatherproof Lakeside 6-Piece Set. Made for comfort and four-season durability, this set allows for flawless outdoor entertainment.
CFLS4100 \$3,792



Lakeside 3-Piece Round Bar Arm Chair Set

Your porch, patio, or balcony deck will become a relaxing retreat in no time at all when you bring this Lakeside set into the scene. Sit back and relax and enjoy.
CFLS2400 \$1,948



Patio Collection

- CFDS100** Deep Seating Chair with arms. Includes cushions. **\$1,281**
- CFDS101** Deep Seating Foot Stool with cushion. **\$591**
- CFDS102** Deep Seating Love Seat with cushions. **\$2,168**
- CFDS103** Deep Seating Sofa with cushions. **\$3,444**
- CFDS110** Side Table **\$494**
- CFDS112** Coffee Table **\$773**



Country Living Deep Seating Ottoman

A comfortable, inviting place to linger and take in the fresh air, this deep seating ottoman is as cozy as can be.
CFCL2350 \$611



Country Living 4-Piece Deep Seating Set

From quiet morning rituals to cozy evening gatherings, this deep seating set creates an outdoor living space that invites and delights.
CFCL2300 \$6,671



Lakeside 6-Piece Lounge Sofa Set

Entertaining is easy with the Lakeside 6-Piece Lounge Sofa Set. With seating for up to seven, your guests will love relaxing in the weather-resistant cushions during every season.
CFLS3700 \$6,400



CUSTOMIZE & ADD YOUR OWN MESSAGE & LOGO!

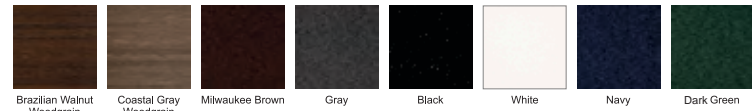



WASTE & RECYCLE ENCLOSURES

PRICE MATCH GUARANTEE *with Any Major Competitor*

WASTE ENCLOSURES



Pro Series Trash Container
Rotomolded round trash container with a plastic lumber lid that is tough and durable. Comes with a donut lid but can be ordered with a solid lid. 18" tall x 17" wide.

- GT500** Complete Trash Container **\$466**
- GT501** Container Only **\$279**
- GT502** Replacement Lid **\$79**



Slatted Trash Container

14" x 14" x 17"

- GT1050** With Donut Lid and 5 gallon Liner **\$375**
- GTLID** Replacement donut or solid lid only **\$75**



Custom Message Trash Ring

Customized lids can be special ordered with your preferred message.

Round Slatted Trash Container

Our slatted enclosure houses a rigid liner and features a lift-off lid. Available in many colors and sizes.

- GT1810** 20"x20"x22", 10 gallon. **\$551**
- GT1820** 20"x20"x24", 20 gallon. **\$617**
- GT1832** 20"x20"x32", 32 gallon. **\$719**



Square Slatted Trash Container

The slats and frame are all plastic lumber construction, while the enclosure houses a Rubbermaid trash can. Features a lift off lid for easy access.

- GT1120** 26"L x 19"W x 23"H, 20 gallon. **\$877**
- GT1132** 26"L x 19"W x 29"H, 32 gallon. **\$973**
- GT1144** 26"L x 19"W x 33"H, 44 gallon. **\$1,103**



Square Top Load Trash Container

All plastic lumber construction with 2"x4" frame and routed pattern panels. Lift off lid and rigid liners included.

- GT1010** 19"L x 19"W x 19"H, 100 gallon. **\$613**
- GT1020** 24"L x 24"W x 24"H, 20 gallon. **\$733**
- GT1032** 26"L x 26"W x 31"H, 32 gallon. **\$908**
- GT1044** 31"L x 32"W x 33"H, 44 gallon. **\$1,004**



Ace Series Trash Container

Rotomolded square container with a plastic lumber lid that is tough and durable. Comes with an open lid but can be ordered with a solid lid. 16"L x 16"W x 20"H

- GT400** Complete Trash Container **\$466**
- GT401** Container Only **\$279**
- GT402** Replacement Lid **\$79**
- GT403** Liner Only **\$108**



CUSTOMIZE & ADD YOUR OWN MESSAGE & LOGO!





WASTE & RECYCLE ENCLOSURES

PRICE MATCH GUARANTEE *with Any Major Competitor*

WASTE ENCLOSURES



Curve Top Trash Container

The Century Curve top adds new style to your course. All plastic lumber construction mounted to a sturdy 2"x2" frame holds a 26 gallon liner. Available in Single, Double and Triple units. Add your logo.

- GT2526** Single Unit 19"L x 19"W x 37"H **\$1,131**
- GT2526D** Double Unit 38"L x 19"W x 37"H **\$1,526**
- GT2526T** Triple Unit 57"L x 19"W x 37"H **\$2,671**
- GTFLAP** Add Covers over Trash Openings **\$99.95**



Side Load Trash Container

- GT2116** 16 gal. 16"L x 16"W x 36"H **\$567**
- GT2126** 26 gal. 19"L x 19"W x 36"H **\$891**
- GT2126C** 26 gal. with logo **\$996**
- GT2100A** Add Ash Tray **\$101**
- GT2000D** Add Optional Hinged door **\$75**

All plastic lumber construction, routed pattern panels and a 2"x2" frame makes these waste enclosures the perfect fit for your course. A lift off lid is standard for these units although a hinged door can be ordered along with an optional ashtray. The 16 or 26 gallon liner is included.



Top Load Trash Enclosure

All plastic lumber construction. Features a lift off lid to access the rigid trash liner and is available in all colors. Add your logo.

- GT2016** 16 gal. 17"L x 17"W x 31"H **\$541**
- GT2026** 26 gal. 18"L x 18"W x 34"H **\$807**

Top Load Enclosure

All plastic lumber construction featuring a lift off lid. Includes a rigid liner.

- GT2316** 16 gal. 17"L x 17"W x 28"H **\$656**
- GT2326** 26 gal. 19"L x 19"W x 35"H **\$845**

Top Load Enclosure

26 gallon - 18"L x 18"W x 34"H Century Top Load Enclosure. Plastic lumber construction with a 2"x2" frame. Includes rigid liner. Available in any color.

- GT1526** **\$921**



Recycle Side Load Trash Container

This Recycle waste enclosure is a great way to promote recycling. They can be ordered in Single, Double and Triple units. Includes a hinged door and a 26 gallon rigid liner. Order in Blue or the color of your choice.

- GT2226** Single Unit 19"L x 19"W x 36"H **\$968**
- GT2226-HD** Hinged door is an added option standard with lift off lid. **\$75**
- GT2226D** Double Unit 37"L x 19"W x 45"H **\$1,916**
- GT2226T** Triple Unit 54"L x 19"W x 45"H **\$2,775**



WASTE & RECYCLE ENCLOSURES



WASTE & RECYCLE ENCLOSURES

PRICE MATCH GUARANTEE *with Any Major Competitor*

WASTE ENCLOSURES



Tribute Collection Side Load Waste Enclosure

This waste enclosure features trash flaps, a 26 gallon liner, and a lift off lid for easy use. It can be fully customized in your choice of colors to match your course or clubhouse style.

19" L x 19" W x 41" H
GT2626 \$1,150



The Baywood Trash Container

26 gal., 19" L x 19" W x 35" H

This popular trash enclosure features a top load configuration with a hinged lid and flap that seals the trash to keep birds and insects out. Order in any color and add your logo.

GT2025 \$931



Tribute Collection Top Load Waste Enclosure

This trash enclosure includes a 26 gallon liner and a convenient lift off lid, making it perfect for easy use and maintenance. Plus, it's fully customizable to fit your ideal color combination, so it can seamlessly match your course's aesthetic. 20" L x 20" W x 36" H Tall

GT2426 \$1,035



Score Card Caddy/Trash Enclosure

This side load trash enclosure is the perfect solution for heavier traffic areas on the golf course. It features a convenient scorecard caddy on top, giving golfers a place to grab their scorecards and pencils. Inside, a 26 gallon liner provides ample capacity for trash.

Add your logo to fully customize for your course.

GT2175 \$1,256



Side Load Trash Enclosures

16 gal., 17" x 17" x 31"
Plastic lumber construction with a lift off lid. Includes rigid liner. Personalize it with your own logo.

GT1350 26 gallon 17" L x 17" W x 31" H \$858
GT1316 16 gallon 14" L x 14" W x 36" H \$765

Side Load Trash Enclosure

Featuring all plastic lumber construction, this enclosure has a hinged lid that lifts off for trash removal. Includes a 16 gallon rigid liner. 17" L x 17" W x 31" H

GT1246 \$612



Side Load Trash Enclosure

Featuring all plastic lumber construction, this enclosure has a hinged lid that lifts off for trash removal. Includes a 26 gallon rigid liner.

GT1256 26 Gallon 20" L x 20" W x 29" H \$786
GT1266 32 Gallon 24" L x 24" W x 39" H \$995



9-Gallon Litter Caddy

Made from 20-gauge steel with rich, durable powder-coat finish. Choose from a 4.5" spike bottom or a solid base bottom.

STD13150	Red with Spike	\$115
STD13175	Blue with Spike	\$115
STD13400	Yellow with Spike	\$115
STD13700	Green with Spike	\$115
STD13195	Black with Spike	\$115
STD13140	Chrome with Spike	\$115
STD13152	Red with Base	\$115
STD13177	Blue with Base	\$125
STD13500	Yellow with Base	\$125
STD13800	Green with Base	\$125
STD13197	Black with Base	\$125
STD13142	Chrome with Base	\$125

30-Gallon Tapered Litter Caddy

Made from 20-gauge steel with rich, durable powder-coat finish. Choose from a 12" spike bottom or a solid base bottom.

STD13050	Red with Spike	\$285
STD13080	Blue with Spike	\$285
STD13025	Yellow with Spike	\$285
STD13075	Green with Spike	\$285
STD13095	Black with Spike	\$285
STD13040	Chrome with Spike	\$285
STD13053	Red with Base	\$305
STD13083	Blue with Base	\$305
STD13028	Yellow with Base	\$305
STD13078	Green with Base	\$305
STD13098	Black with Base	\$305
STD13043	Chrome with Base	\$305

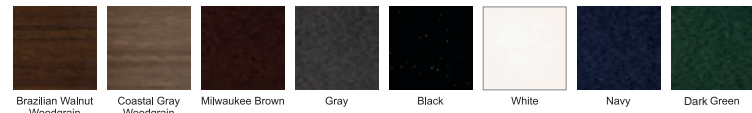



WASTE & RECYCLE ENCLOSURES

PRICE MATCH GUARANTEE *with Any Major Competitor*

RECYCLE ENCLOSURES



Double Recycle Center

This double recycle center will help keep your course and the environment clean. This unit holds two 26 gallon rigid liners and features hinged doors and sturdy construction. Customize to fit your needs. 37"L x 19"W x 45"H

GT2926DT \$2,520



Curve Top Trash & Recycle Container

Keep your course clean in style. This unit has hinged doors and includes two 26 gallon trash liners. Can be customized to fit your needs. Engraving of your choice. Double Unit

38"L x 19"W x 37"H
GT2526DTC \$2,520



Triple Trash Recycle Center

This triple trash recycle containers center will help keep your course and the environment clean. Stylish construction with three hinged doors and includes three 26 gallon trash liners. Can be customized to fit your needs with engraving of your choice. 54"L x 19"W x 45"H

GT2926T \$2,217



Double Trash Container

Our double trash containers with two 26 gallon liners features all plastic lumber construction with a routed panel and 2x2 trim. 37"L x 19"W x 45"H

GT2926D \$1,603



Square Trash Liners

TLS16	16 gallon	\$124
TLS26	26 gallon	\$130
TLM10	10 gallon	\$85
TLM20	20 gallon	\$84
TLM32	32 gallon	\$96
TLM44	44 gallon	\$146

Round Trash Liners

TLR3.5	3.5 gallon	\$22
TLR5	5 gallon	\$24
TLR16	16 gallon	\$124
TLR20	20 gallon	\$116
TLR26	26 gallon	\$129
TLR32	32 gallon	\$124



Cooler Trash Combo

This convenient unit is the perfect solution for keeping your course tidy and your beverages cold. It includes a 54 quart ice chest for drinks and a 26 gallon trash enclosure, providing a single, compact station for both. 49"L x 18"W x 36"H

GT3100 \$1,837



WASTE & RECYCLE ENCLOSURES



WASTE & RECYCLE ENCLOSURES

PRICE MATCH GUARANTEE *with Any Major Competitor*

TOWEL STATION ENCLOSURES

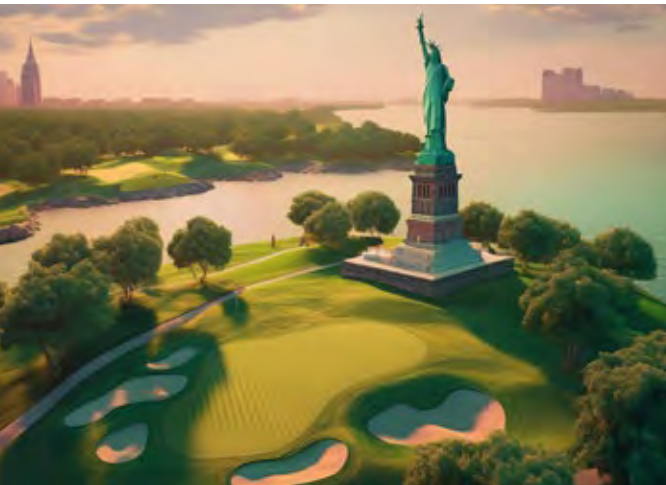

Triple Trash and Towel Station
Includes three 26 gallon trash liners and towel liner.
Can be customized to fit your needs.
Logo optional. 72"L x 19"W x 45"H
GT2926TS \$2,805



Towel Center
Includes a 26 gallon trash liner and shelves for towel placement. Can be configured in different ways depending on your specific needs. Logo optional.
37"L x 19"W x 45"H
GT3000 \$1,743



Premium Towel Station
Versatile and practical, this towel station features two customizable doors designed to house trash, recycling, or soiled towels. The spacious center compartment provides ample room for fresh towels or other guest essentials, making it an ideal addition for maintaining cleanliness and convenience at your facility.
GT3025 \$2,143



Double Towel Valet Center
This recycled plastic valet includes two 16 gallon liners for used towels and plenty of storage for folded towels. Customize with your course logo.
GT4500 \$4,536



Customized Towel Station
Elevate your resort experience with our premium towel station. Designed with one central door and two openings on each side, it includes an internal middle shelf for organized storage. Perfect for neatly housing towels or other guest essentials, this stylish and functional unit ensures convenience and a polished look for any poolside, spa, or resort setting.
GT3050 \$1,943

Ice Chest Cabinet

This convenient unit is the perfect solution for keeping your course tidy and your beverages cold. It's designed to hold a 54 quart cooler and includes two 26 gallon trash liners for a clean, efficient waste enclosure. A spacious storage area is also included, and you can customize the unit with verbiage of your choice and add a logo. 68"L x 20"W x 40"H

GW4500 \$3,043



Triple Towel Stop
Three containers are designed to hold water, clean towels and dirty towels. Housing contains three 10 gal. rigid liners and features a lift-off lid.
GT3015 \$1,344

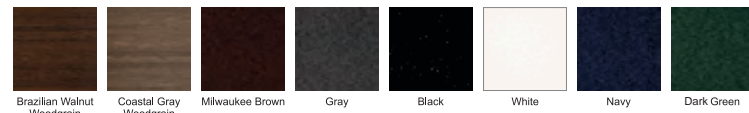

WASTE & RECYCLE ENCLOSURES



TEE AREA

PRICE MATCH GUARANTEE *with Any Major Competitor*

DIVOT MIX CONTAINERS



Pro Series Round Divot Mix Container

Rotomolded round divot mix container with a plastic lumber lid that is tough and durable 18" tall x 17" wide. Includes Scoop.

- GD500 Complete divot mix container \$466
- GD501 Container only \$278
- GD502 Replacement lid \$79



GD1040

GD1050

GD1060

Round Slatted Divot Mix Container

This divot mix container is a durable solution for your course. Its round, slatted design is made from recycled plastic, and it's reinforced with sturdy, powder coated rings to prevent rust. The container holds a rigid liner, ensuring it maintains its shape and functionality for years. Included Scoop.

- GD1040 with lid, bucket and scoop. 3.5 gal size. 14"L x 14"W x 14"H \$324
- GD1050 with lid, bucket and scoop. 5 gal size. 14"L x 14"W x 17"H \$374
- GD1060 with lid, bucket and scoop. 10 gal size. 20"L x 20"W x 22"H \$620

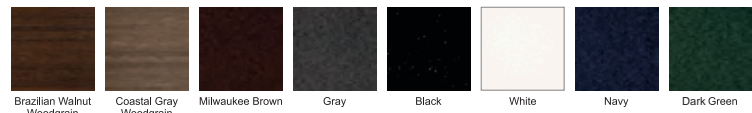

Small Divot Mix Boxes

This compact and functional divot mix box features a convenient hinged lid and comes complete with a scoop, making it easy for golfers to replace divots.

- GD1010 3.5 gallon 14"L x 13"W x 12"H \$305
- GD1011 2.5 gallon - 14"L x 13"W x 10"H \$291

5 Gal. Divot Mix Container

Great for tee areas, the GD1000 features all plastic lumber construction and features a hinged lid and included scoop. Holds approximately 5 gal. of mix.

- 19"L x 13"W x 12"H
- GD1000 \$394



Divot Mix Scoop

Replacement divot mix scoop.

- GDSCOOP \$9



Ace Divot Mix Containers

Our new molded divot mix container holds 9 gallons and has a recycled plastic lift off lid. 16"L x 16"W x 20"H. Can be ordered in custom colors at no extra cost.

- GD400 Complete divot mix container \$466
- GD401 Container only \$278
- GD402 Replacement lid \$79
- GD403 Liner only \$117



7 Gal. Divot Mix Box

This is a slightly larger divot mix box that holds approximately 7 gallons of divot mix. The 2x2 construction lifts the box off the ground, allowing for sunlight on the turf.

- 13"L x 18"W x 16"H
- GD1005 \$415



Divot Mix Enclosure

This divot mix container has a hinged lid and holds a rugged 10 gallon liner. Scoop is included 18"L x 18"W x 18"H

- GD1210 \$578

TEE AREA



CUSTOMIZE & ADD YOUR OWN MESSAGE & LOGO!



TEE AREA

PRICE MATCH GUARANTEE *with Any Major Competitor*

DIVOT MIX CONTAINERS



Tribute Collection Divot Mix Bottle Box

This is the perfect solution for keeping your divot mix organized and accessible! This box is designed to accommodate up to 12 divot mix bottles or can be used as a divot mix box with a scoop. Just let us know your preference when you order. Fully customizable in any color combination to fit your course's style!

24"L x 20"W x 18"H

GD1515 \$615



Raised Bulk Divot Mix Storage Box

Constructed entirely from plastic lumber, this box features a sturdy design on 2x4 legs that elevates the box off the ground. The hinged lid provides easy access to the divot mix while keeping the contents protected. Holds approximately 50 gallons of divot mix.

39"L x 20"W x 33"H

GD1130 \$1,046



Raised Divot Mix Container

7 gal. All plastic lumber construction with hinged lid. Holds approximately 7 gal.

36"L x 15"W x 29"H

GD1025 \$490



Raised Divot Mix Container

All plastic lumber construction on raised 2" x 2" legs for ease of access. Hinged lid and scoop included. Holds approximately 5 gal. of divot mix.

17"L x 12"W x 27"H

GD1004 \$430



Raised Divot Mix Container

All plastic lumber construction on raised 2" x 2" legs for ease of access. Hinged lid and scoop included.

Holds approximately 10 gallons of divot mix.

20"L x 15"W x 27"H

GD1006 \$520



Raised Divot Mix Container w/ Angled Lid

Constructed from plastic lumber and features an angled lid to prevent water from collecting. The extended 2" x 2" legs lift the box off the ground, allowing sunlight to reach the turf underneath. Holds approximately 10 gallons of divot mix.

22"L x 15"W x 27"H

GD1007 \$430



Medium Capacity Bulk Divot Mix Storage Box

Our most popular divot mix storage box made from heavy duty reinforced plastic lumber. 2"x2" frame, hinged lid. Holds up to 65 gal. of mix and features integrated handles to help with moving.

41"L x 18"W x 21"H

GD1110 \$1,044



Extra Large Storage Box

This extra large storage box is built for durability and convenience. Made from heavy duty reinforced plastic lumber, it's designed to withstand the elements and provide a secure storage solution for your course. 60"L x 18"W x 21"H

GD1112 \$1,092

TEE AREA



CUSTOMIZE & ADD YOUR OWN MESSAGE & LOGO!

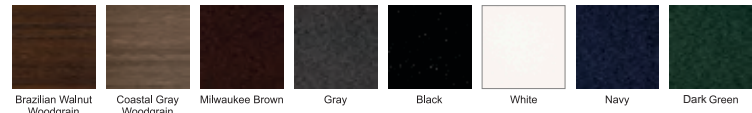



PRICE MATCH GUARANTEE *with Any Major Competitor*

DIVOT MIX CONTAINERS



Large Heavy Duty Divot Mix Storage Box
If you are looking for the strongest bulk storage box, you just found it. This burly box features with 4"x4" legs and a 2"x4" frame, solid panels and a hinged lid. 42"L x 29"W x 31"H
GD1100 \$1,562



Small Divot Bottle Box
Small Divot Bottle Box plastic lumber with hinged lid. Holds 12 bottles. 22"L x 17"W x 18"H
GD1509 \$382



Large Capacity Bulk Divot Mix Storage Box
Our most popular large divot mix box, it features all reinforced plastic lumber construction with an internal frame for extra support. Heavy duty stainless strap hinges will last the life of the unit. 2 x 2 frame. 36"L x 36"W x 33"H
GD1120 \$1,347



Medium Bottle Storage Box
Hold up to 25 bottles in this strong, plastic lumber box. It sits on 2"x4" legs and features a hinged lid. 28"L x 28"W x 27"H
GD1300 \$1,019



Large Bottle Storage Box
With twice the capacity of our GD1300, this box holds 50 divot mix bottles and features all plastic lumber construction on 2"x4" legs. Hinged lid for easy access. 45"L x 27"W x 26"H
GD1350 \$1,226

Extra Large Heavy Duty Divot Mix Storage Box
This storage box is built for ultimate durability and convenience. It features a robust construction of reinforced plastic lumber, supported by sturdy 4" x 4" legs and a strong 1" x 4" frame. The split lid design makes it easy to open and load, while stainless steel hinges prevent rust and corrosion. 71"L x 28"W x 32"H
GD1101 \$2,846



TEE AREA



CUSTOMIZE & ADD YOUR OWN MESSAGE & LOGO!

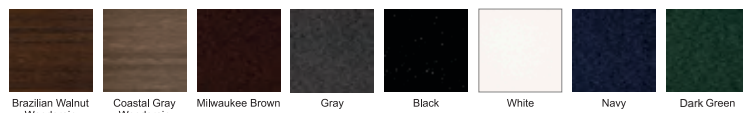



TEE AREA

PRICE MATCH GUARANTEE *with Any Major Competitor*

BOTTLE RACKS & BOTTLES



Divot Bottle Rack

Recycled Plastic Construction with 4" Diameter Holes. Holds 12 bottles Box is 21"L x 16"W x 9"H

- GD1412 Permanent Mounted on 4"x4"x60" Legs \$889
- GD1412-01 Portable Mounted on 4"x4"x48" Legs with Feet \$939



Divot Bottle Rack

Recycled Plastic Construction with 4" Diameter Holes. Holds 16 bottles Box is 41"L x 12"W x 9"H

- GD1416 Permanent Mounted on 4"x4"x60" Legs \$954
- GD1416-01 Portable Mounted on 4"x4"x48" Legs with Feet \$1,025



Divot Bottle Rack

Recycled Plastic Construction with 4" Diameter Holes. Holds 24 bottles with Handles Box is 41"L x 24"W x 9"H

- GD1524 Permanent Mounted on 4"x4"x60" Legs \$1,071
- GD1524-01 Portable Mounted on 4"x4"x48" Legs with Feet \$1,121

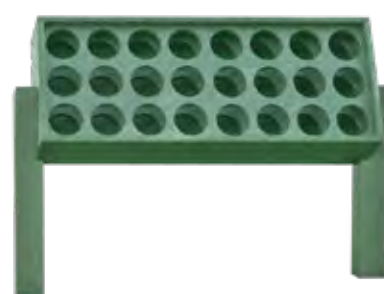

Divot Bottle Rack

Recycled Plastic Construction with 4" Diameter Holes. Holds 24 bottles without Handles

- GD1475 Permanent Mounted on 4"x4"x60" Legs \$968
- GD1475-01 Portable Mounted on 4"x4"x48" Legs with Feet \$1,051



Raised Portable Divot Bottle Rack

Raised on legs for easy access. 24 bottle capacity, divided for 15 full and 9 empty bottles. 42"L x 19"W x 44"H

- GD1465 \$1,631

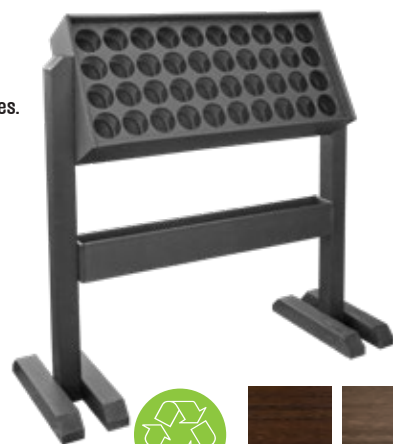

Divot Bottle Rack

Recycled Plastic Construction with 4" Diameter Holes. Holds 40 bottles. Box is 48"L x 22"W x 9"H

- GD1480 Permanent Mounted on 4"x4"x60" Legs \$1,087
- GD1480-01 Portable Mounted on 4"x4"x48" Legs with Feet \$1,172
- GD1478 Empty Bottle Box Mounted to Inside of 4"x4" Legs \$411



Permanent Full/Empty Divot Bottle Rack

This large bottle rack is divided for 28 full and 12 empty bottles with handles. Box Measures 67"L x 23"W x 9"H.

- GD1485 \$1,255

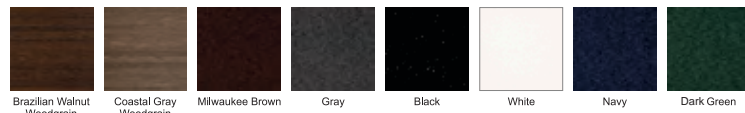

Divot Mix Bottles

A.	GD1580	35 Oz Top Fill	\$26
B.	GD1582	Seed Tube 16 Oz with Clip	\$26
C.	STD18952	40 Oz Bottom Fill	\$28
D.	STD18800	78 Oz Bottle with Steel Powder Coated Black Holder	\$73
E.	STD18900	78 Oz Bottle with Steel Powder Coated Green Holder	\$73
F.	STD18802	78 Oz Bottom Fill	\$16
G.	STD18955	40 Oz Bottom Fill with Handle	\$28



Small Divot Bottle Caddy

Divot Bottle Caddy. Holds 12 bottles and offers portable convenience. 17"L x 21"W x 18"H

- GD1525 \$297



Dual Divot Bottle Holder w/ Full/Empty Trays

Holds 15 Full and 15 Empty One Quart Bottles 29"L x 18"W x 35"H

- GD1675 \$1,244



Replacement Box for Single or Double Bottle Holder

Holds 15 bottles and can be used by itself or with bottle caddy racks. 28L x 16"W x 9"H

- GD1700 \$289



Single Divot Mix Bottle Holder

All plastic lumber construction. Holds 15 bottles. 29"L x 18"W x 35"H

- GD1600 \$692



Double Divot Mix Bottle Holder

Side-by-side, holds 30 bottles. 58"L x 18"W x 35"H

- GD1650 \$1,314

TEE AREA





TEE AREA

PRICE MATCH GUARANTEE *with Any Major Competitor*

BALL WASHERS



Sparkleen Ecomax Detergent Tablets
STD03100 - 450 count jar. **\$114**

Sparkleen Liquid Detergent
STD03300 - Case of 4 - 1 gallon **\$75**

Economy Tee Towels
STD04969 200 per case. 21" H x 7" W duo-fold **\$155**

Embroidered Tee Towels
STD04970 Chix Washable Tee Towels Absorbent and reusable. Green, 200 per case. 21" H x 7" W duo-fold **\$219**

JF-TWLBLK 16" X 25" Black with Grommet and Clip **\$180 per dozen**
JF-TWLGRN 16" X 25" Hunter Green with Grommet and Clip- \$180 per dozen Other Colors Available Upon Request. **\$180 per dozen**

Value Tee Towels
STD04510 Black Value Towel Microfiber, Machine washable. Priced per dozen 21" H x 7" W duo-fold **\$40**

STD04511 Green Value Towel Microfiber, Machine washable. Priced per dozen 21" H x 7" W duo-fold **\$40**

*See page 145 for embroidered towels



Classic Ball Washer [four ball]
 Crank style washer with four ball capacity. Built-in overflow tubes prevent leaks and soap buildup. New and improved brush design.

- STD01325** Red, 3.7 pints **\$213**
- STD01350** Green, 3.7 pints **\$213**
- STD01370** Black, 3.7 pints **\$213**
- STD01300** Yellow, 3.7 pints **\$213**
- STD01340** Brown, 3.7 pints **\$213**
- STD01375** Blue, 3.7 pints **\$213**



Premier Ball Washer [single ball]
 Simple design, only one moving part. New and improved brush design.

- STD01420** Red, 7.5 pints **\$375**
- STD01460** Black, 7.5 pints **\$375**
- STD01440** Green, 7.5 pints **\$375**



Medalist Ball Washer [Single Ball]

- STD01525** Red, 3.25 pints **\$325**
- STD01570** Black, 3.25 pints **\$325**
- STD01550** Green, 3.25 pints **\$325**

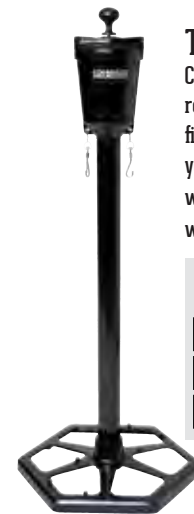

Tradition Tee Console Kit #1
 Classic. Robust. Versatile. 19" cast aluminum base make it easy to reposition to reduce wear and tear. Includes spikes to anchor it firmly into the ground. Includes Tradition Console Stand [Black] and your choice of a Premier or Medalist Ball Washer. w/ Premier ball washer - **\$600**
 w/ Medalist ball washer - **\$560**

	With Medalist Ball Washer	With Premier Ball Washer
Red	STD39225	STD39125
Green	STD39250	STD39150
Black	STD39270	STD39170



Tradition Tee Console Kit #2
 Classic. Robust. Versatile. 19" cast aluminum base make it easy to reposition to reduce wear and tear. Includes Tradition Console Stand [Black] and your choice of a Premier or Medalist Ball Washer, plus matching single Litter Mate unit. Customizable Premier Ball Washer and Litter Mate. w/ Premier ball washer - **\$720**
 w/ Medalist ball washer - **\$690**

	With Medalist Ball Washer	With Premier Ball Washer
Red	STD39425	STD39325
Green	STD39450	STD39350
Black	STD39470	STD39370



Tradition Tee Console Kit #3
 Classic. Robust. Versatile. 19" cast aluminum base make it easy to reposition to reduce wear and tear. Includes spikes to anchor it firmly into the ground. Includes Tradition Console Stand [Black] and your choice of a Premier or Medalist Ball Washer, plus matching double Litter Mate unit. Customizable Premier Ball Washer and Litter Mate. w/ Premier ball washer - **\$825**
 w/ Medalist ball washer - **\$775**

	With Medalist Ball Washer	With Premier Ball Washer
Red	STD39625	STD39525
Green	STD39650	STD39550
Black	STD39670	STD39570

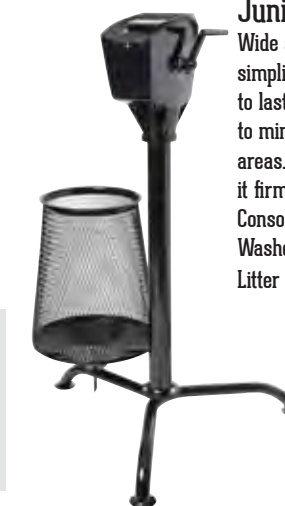

Junior Tee Console Kit
 Wide stanced tripod style stand combines simplicity, utility, affordability; and it is built to last. Very portable. Easy to move around to minimize wear and tear in high traffic areas. Screw in stakes [included] anchor it firmly into the ground. Includes Junior Console Stand [Black] with a Classic Ball Washer and color matched 9 gallon [34 L] Litter Caddy with spike. - **\$495**

	With Classic Ball Washer
Red	STD39825
Green	STD39850
Black	STD39870



Ground Anchor
 18" [46 cm] Ground Anchor **STD36205 \$49**



Permanent Mounting Post
 48" [122 cm] Post **STD36248 \$99**



Junior Tee Console
 Junior Console Stand **STD36200 \$189**



Tradition Tee Console
 Tradition Console Stand **STD36230 \$250**

TEE AREA



TEE AREA

PRICE MATCH GUARANTEE with Any Major Competitor



TEE MARKERS

Tee markers are essential for any golf course. They provide a clear visual guide for golfers to know where to begin play on each hole. We offer a wide range of tee markers in various styles and in laminate, laser cut metal, cast bronze and cast aluminum to match the unique aesthetic of your course. No matter the style, our tee markers are built to withstand the elements and maintain a professional appearance for years.



Triangle Tee Marker
With steel spike. Available in any color.
1/4" Steel Spike
GTM1040 \$20



Capital Tee Marker
4" x 4" x 6" with a steel spike.
Available in any color. 1/4" Steel Spike
GTM1010 \$22



Beveled Tee Marker
4" x 4" x 6" with steel spike.
Available in any color. 1/4" Steel Spike
GTM1400 \$22



Capital Tee Marker w/ Colored Stripe
w/ vinyl stripe and spike. Available in any color. 1/4" Steel Spike
GTM1010S \$27



Broken Tee Caddies
GBT100 Made with wire mesh bottom. 9" x 7" x 4" \$65
GBT101 Made with wire mesh bottom. 9" x 7" x 2" \$44
GBT102 Made with wire mesh bottom 6 1/2" x 8 1/4" \$62



Timber Tee Marker
Natural, rustic look on stainless steel spikes molded into tee marker. Priced individually, sold in sets of 2 - \$30
3 1/8" H x 2 3/4" W x 9 1/2" D 2" spikes

Red	Red	STD05610
White	White	STD05611
Blue	Blue	STD05612
Yellow	Yellow	STD05613
Black	Black	STD05614
Gold	Gold	STD05615
Orange	Orange	STD05616
Green	Green	STD05617
Purple	Purple	STD05618



Oak Tee Marker
Natural, rustic look on a single stainless steel spike molded into tee marker. Priced individually, sold in sets of 2 - \$24
4 1/4" H x 4" W 3 1/2" spikes

Red	Red	STD05610
White	White	STD05611
Blue	Blue	STD05612
Yellow	Yellow	STD05613
Black	Black	STD05614
Gold	Gold	STD05615
Orange	Orange	STD05616
Green	Green	STD05617
Purple	Purple	STD05618



Plain Dimple T Marker
The most durable ever built and a favorite worldwide. - \$14
5" Diameter 4 1/2" spikes

Red	Red	STD05610
White	White	STD05611
Blue	Blue	STD05612
Yellow	Yellow	STD05613
Black	Black	STD05614
Gold	Gold	STD05615
Orange	Orange	STD05616
Green	Green	STD05617



Personalized Dimple T Marker
Personalize your Dimple T Marker. - \$14
5" Diameter / Decal 3" 4 1/2" spikes

Red	Red	STD05610
White	White	STD05611
Blue	Blue	STD05612
Yellow	Yellow	STD05613
Black	Black	STD05614
Gold	Gold	STD05615
Orange	Orange	STD05616
Green	Green	STD05617



Round EPCO Markers
Round EPCO Tee Markers are made from solid one piece construction from specially formulated engineering grade thermoset resin compounds. Available in 4" With Neck or Without Neck and can be ordered with a flat top. Call for quote to add your custom engraved logo.
JF-EP-DGTM1000 Series 1000 - Round Tee Markers \$24
JF-EP-CGTM2000 Series 2000 - Round Tee Markers w. flat top \$34



Custom Laminate Tee Markers
The main benefit of laminate is its design freedom. These markers can be customized into any shape you can imagine from a simple circle to a complex logo design. You can also incorporate your course's specific colors, branding, and graphics, ensuring a polished, consistent look across the entire property. This ability to precisely match your brand gives your course a unique and sophisticated feel that other materials can't easily replicate. Each tee marker includes two spikes which prevent as little turf damage as possible and area available in any of our numerous laminate plastic colors.
GTM1800 Single Sided \$32.75
GTM1800D Double Sided \$39.75

TEE AREA



PRICE MATCH GUARANTEE *with Any Major Competitor*

TEE MARKERS

Custom Bronze & Aluminum Markers

Our custom bronze and aluminum tee markers are a great way to add a touch of class to your course. These durable, high quality tee markers can be designed in any shape to perfectly incorporate your course's logo, ensuring a custom look that sets your brand apart.



Custom Bronze & Aluminum Tee Marker

These products can be fully customized to fit the unique needs of your club or course. We can design them in the exact shape of your logo or graphic, ensuring a perfectly tailored look that enhances your brand and provides a truly custom feel.

GTM1500 Call for a Quote



Vertical Wedge Tee Marker

Vertical wedge tee markers are available with both bronze and aluminum plates attached. Choose from our standard plastic wedge colors. Includes (x2) screws with painted heads to match. Plaque is 3.25"x4" mounted on 3.5"x3.5"x6" tall recycled plastic.

- JF-TM-PED-BZ** Bronze Plaque on Marker **\$91.50**
- JF-TM-PED-AL** Aluminum Plaque on Marker **\$83.50**
- JF-TM-VM-BZ** Bronze Plaque Only **\$48.75**
- JF-TM-VM-AL** Aluminum Plaque Only **\$42**



Lolly pop Tee Marker

Mounting spikes are cast into marker for easy and durable mounting. Use our standard 5" diameter shape shown to the left, or call us for custom shape and size options.

- JF-LTM-BZ** 5" Single Sided Bronze **\$70**
- JF-LTM-AL** 5" Single Sided Aluminum **\$55.50**
- JF-LTM-BZ** 5" Double Sided Bronze **\$83.25**
- JF-LTM-AL** 5" Double Sided Aluminum **\$66.50**



Laser Cut Steel Tee Markers

Laser cut tee markers are a modern and highly customizable solution for any golf course. Crafted with industrial grade lasers, this process delivers an incredible level of precision and detail that traditional manufacturing can't match. It allows your tee markers to be created in virtually any custom shape, perfectly incorporating your course's unique logo or brand identity for a clean, professional, and distinctive look. Our Laser Cut Tee Markers are made of 11 gauge [-0.125" thick] stainless steel and are designed to withstand the elements. Set up charges are waived for orders of 20 or more tee markers.

- JF-Laser-TeeMKR** Size up to 80 square inches **\$48.75**
- JF-Laser-TeeMKR-1** Size over 80 square inches **Call for Quote**



Tee Marker Shapes

Our bronze and aluminum tee markers are available in eight standard sizes to perfectly fit the needs of your course. Each marker is crafted for durability and a professional look. You can order these as either single-sided or double-sided markers, offering flexibility for your course's layout and traffic flow. All tee markers come assembled with two 1/4-20 4" length stainless steel spikes. Custom shapes available. Pricing shown is for double sided. Setup charges are waived for orders of 30 or more tee markers.

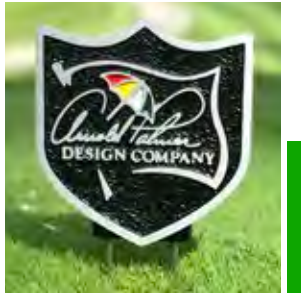

Shape 1			Shape 2			Shape 3			Shape 4		
Size	Bronze	Aluminum	Size	Bronze	Aluminum	Size	Bronze	Aluminum	Size	Bronze	Aluminum
4" X 6"	JF-TM-01-A-BZ	JF-TM-01-A-AL	4" X 6"	JF-TM-02-A-BZ	JF-TM-02-A-AL	4" X 6"	JF-TM-03-A-BZ	JF-TM-03-A-AL	4" X 6"	JF-TM-04-A-BZ	JF-TM-04-A-AL
5" X 7"	JF-TM-01-B-BZ	JF-TM-01-B-AL	5" X 7"	JF-TM-02-B-BZ	JF-TM-02-B-AL	5" X 7"	JF-TM-03-B-BZ	JF-TM-03-B-AL	5" X 7"	JF-TM-04-B-BZ	JF-TM-04-B-AL

Shape 5			Shape 6			Shape 7			Shape 8		
Size	Bronze	Aluminum	Size	Bronze	Aluminum	Size	Bronze	Aluminum	Size	Bronze	Aluminum
4" X 6"	JF-TM-05-A-BZ	JF-TM-05-A-AL	4" X 6"	JF-TM-06-A-BZ	JF-TM-06-A-AL	4" X 6"	JF-TM-07-A-BZ	JF-TM-07-A-AL	4" X 6"	JF-TM-08-A-BZ	JF-TM-08-A-AL
5" X 7"	JF-TM-05-B-BZ	JF-TM-05-B-AL	5" X 7"	JF-TM-06-B-BZ	JF-TM-06-B-AL	5" X 7"	JF-TM-07-B-BZ	JF-TM-07B-AL	5" X 7"	JF-TM-08-B-BZ	JF-TM-08-B-AL

PRICING

Size	Bronze	Aluminum
4" X 6"	\$71.50	\$50
5" X 7"	\$86	\$60

TEE AREA



TEE AREA

PRICE MATCH GUARANTEE with Any Major Competitor

WATER COOLERS



Folding Cooler Tripod
Perfect for temporary water needs on the course. Conveniently folds up for easy storage. 19"L x 19"W x 39"H
GW1200 \$326



Igloo Cooler
10 gal.
GW2200 \$160



Cup Dispenser
Cup dispenser for 4 & 4.5 oz. cups
GW2000 \$72



Round Slatted Water Cooler Enclosure
Round Slatted Enclosure houses an Igloo 10 gal. cooler [not included] Add a cup dispenser to make it complete.
GW1304 Mounted on 6"x6"x60" post **\$1,030**
GW1305 On 6"x6"x36" post and base **\$1,113**



Round Slatted Water Cooler Station
GW1300 Housing only. Holds a 10 gal. Igloo cooler and features a hinged door for easy access. **\$780**
GW1303 On a Tripod. All plastic lumber construction, mounted on a tripod with sturdy 2"x4" legs. Hinged door in front. **\$1,087**



GW2001 Cup Dispenser Bracket **\$14**
GW2002 Igloo Cooler Spigot **\$20**



Tribute Collection Water Cooler on Post
Designed for convenience and versatility! This water cooler is perfect for post mounting, with the option to make it either permanent or portable & is equipped with a cup dispenser and a mounting bracket. This is an ideal addition to any golf course or clubhouse to elevate your course amenities. Please note, the 10 gallon igloo cooler is not included but can be purchased separately through us. Enclosure is 25"L x 25"W x 42"H
GW1003 Permanent Water Cooler on 6"x6"x60" Post **\$2,033**
GW1003P Portable Water Cooler on a 6"x6"x32" Post **\$2,109**



Water Cooler Enclosure
GW1002 - 20"L x 20"W x 72"H
Enclosure on post holds an internal cup dispenser and a 10 gallon igloo cooler. Comes w/ 6"x6"x60" post - **\$1,212**
GW1002NP Enclosure only, no post **\$1,064**



Water Cooler Enclosure
Holds 10 gallon igloo cooler. Cup dispenser mounts on inside giving you access from the base of the unit. mounts on 6" x 6" x 60" post
Portable base option also available. 19"L x 19"W x 34"H
GW1000 **\$1,196**



Water Station Kit
This kit includes the stand, tamper safe top, a 10 gallon Igloo water cooler and the cup dispenser and is available in three colors.
STD45150 Green **\$790**
STD45170 Black **\$790**
STD45125 Red **\$790**

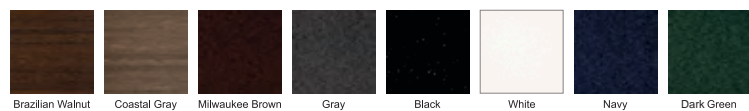

TEE AREA



TEE AREA

PRICE MATCH GUARANTEE *with Any Major Competitor*

WATER COOLERS



Deluxe Canopy Water Cooler
Holds a 10 gallon Igloo water cooler [not included]. Cup dispenser is included and mounts on the inside. Various color combinations are available. 28"L x 25"W x 70"H
GW1151 \$1,763



Classic Cooler Station
Holds a 10 gallon Igloo cooler [not included]. Cup dispenser is included and mounts on the inside. Locking rear access door. 21"L x 21"W x 72"H
GW1175 \$1,865



Deluxe Double Water Cooler Enclosure
Houses two 10 gallon Igloo coolers [not included] and two cup dispensers which are included and mounted inside. All plastic lumber construction and built to last with a 2"x4" frame. 53"L x 25"W x 70"H
GW1152 \$3,215



Double Water Cooler Station
Holds two 10 gallon Igloo coolers [not included]. This station contains two trash containers with swinging flaps and an included cup dispenser. 53"L x 25"W x 72"H
GW1111 \$3,573



Deluxe Double Cooler Station
Holds two 10 gallon Igloo coolers [not included]. Includes two trash containers and two cup dispensers. Great option for high traffic areas or a driving range. 46"L x 21"W x 72"H
GW1102 \$4,015



Deluxe Full Length Cooler Station
Holds a 10 gallon Igloo water cooler [not included], an internal cup dispenser included and mounted and enclosed trash container with a closing trash flap. Your club logo or graphic can be added for an additional fee. 28"L x 25"W x 70"H
GW1101 \$1,915

Tribute Collection Full Length Water Cooler
This enclosure includes a cup dispenser, a mounting bracket, and a 10 gallon trash can, all designed to complement your course's needs & keep your water station organized & accessible. It's available in a variety of colors to match your style and branding. Please note, the 10 gallon igloo cooler is not included but can be purchased through us. 28"L x 24"W x 71"H
GW1109 \$2,670

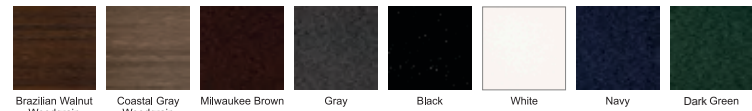

TEE AREA



TEE AREA

PRICE MATCH GUARANTEE *with Any Major Competitor*

BEVERAGE STATIONS



Create Your Custom Beverage or Convenience Station with JFM Golf

Step 1: Discuss Your Vision

Discuss Your Vision And Needs With A Knowledgeable Representative.

We can help you create the perfect beverage or convenience station for your location based on what is needed to service your guests. Any size or style can be created with our professional team at JFM Golf. Contact us today to create a custom station that is sure to impress your guests.

Step 2: Choose Your Accessories

Determine The Best Accessories To Accomplish Your Purpose.

- Do you need an ice chest or a beverage dispenser?
- Do you need straw dispensers, lid dispensers, and cup dispensers?
- Do you need a place to provide clean towels and dispose of the used towels?
- Do you need a place to hold scorecards and tees?
- Do you need storage or shelving?
- Do you need waste receptacles?

Popular Accessories Include:



Straw Dispenser



Lid Dispenser



Cup Dispenser



Custom Food Grade Ice Chest Liner



Ice & Water Dispenser

Step 3: Choose Your Color Scheme

Choose The Color Scheme From Our Numerous Recycled Plastic Color Options.

We use only the highest quality HDPE Recycled Plastic in the industry which is UV resistant, weather resistant, and moisture and insect proof ensuring your convenience station lasts for years to come. Recycled Plastic is low maintenance and easy to clean and resistant to stains and spills.

Color Options:

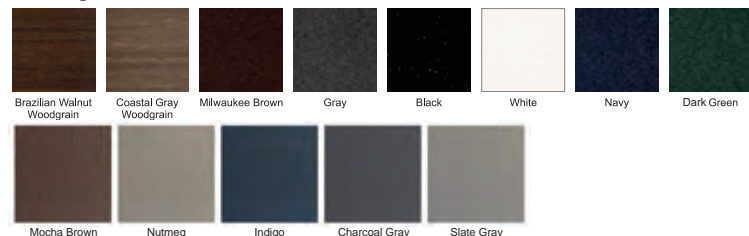

Step 4: Watch Your Vision Become a Reality

Our graphic design team will create a professional, detailed rendering for your review and approval. Once approved, our production team begins bringing the concept to life.

Showcasing a Custom Rendering Designed for a Client:

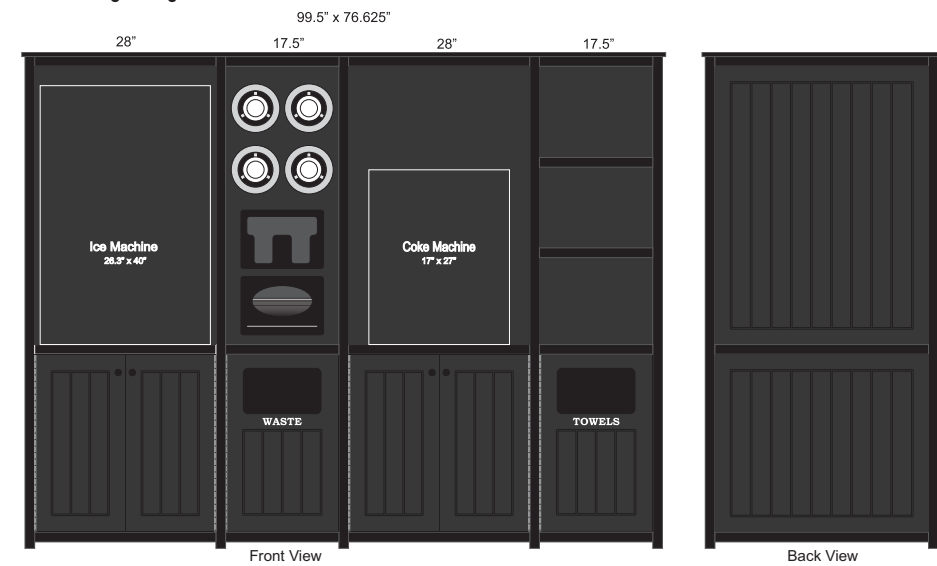

Turning Visionary Renderings Into Real World Results:



TEE AREA



TEE AREA

PRICE MATCH GUARANTEE *with Any Major Competitor*

BEVERAGE STATIONS



Small Beverage Station

Small Beverage Station. Designed to house an ice/water dispenser [not included]. All plastic lumber construction includes two cup dispensers, lid dispenser, and straw dispenser. Also includes a 26 gal. trash container and two hinged doors for storage. Unit can be modified to fit your needs. 42"L x 27"W x 82"H

GW4000 \$4,903



Beverage/Convenience Station

Features a full length water cooler on the left that houses a 10 gal. Igloo cooler and a cup dispenser/trash enclosure below. In the middle, it features a 108 qt. ice chest and on the right, a cup, lid and straw dispensers with an additional trash enclosure below. This unit can be configured many different ways. Give us a call and let us design one to fit your needs.

72"L x 20"W x 82"H

GW4050 \$9,233



Beverage Station/Serving Station

Features a full length water cooler station on the left that houses a 10 gal. Igloo cooler. On the right, it features a serving area for coffee or beverages of your choice. As an option, you can add a 108 qt. ice chest where the serving area is. A two-hinge door offers additional storage. 60"L x 20"W x 70"H

GW4025 \$6,370



Beverage/Serving Station

Features pull out drawers, Enclosed lower storage with shelving. Included Cup Dispensers, Lid Dispenser and Straw Dispenser. Large open center for serving your favorite beverages. If you can dream it we can make it. Call us with your ideas and we can design one for you. 80"L x 27"W x 82"H

GW4075 \$8,766



Beverage Station/Serving Station

Our recycled plastic beverage station four cup dispensers, one lid dispenser, one straw dispenser, and a 10 gallon liner for trash. A large, dedicated compartment provides the perfect space for an ice or soda machine, while additional shelving underneath offers ample storage for supplies.

58"L x 28"W x 77"H

GW5500 \$8,999



Beverage/Convenience Station

This beverage station comes equipped with four cup dispensers, a single lid dispenser, and a straw dispenser, and a 5 gallon trash liner for waste. 22"L x 20"W x 60"H

GW5200 \$3,254



Beverage/Convenience Station

Our space saving beverage station includes two cup dispensers, one lid dispenser, and one straw dispenser, and a 5 gallon liner for trash and a convenient shelf.

16"L x 20"W x 60"H

GW5100 \$3,161

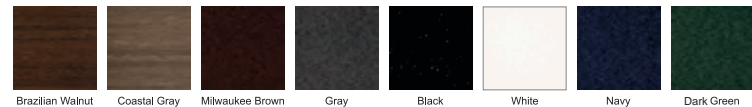

TEE AREA





TEE AREA

PRICE MATCH GUARANTEE *with Any Major Competitor*

WATER COOLERS



- A. **GWDF4405** Wall Mount Outdoor Drinking Fountain **\$2,814**
Stainless steel powder coated for long lasting good looks.
- B. **GWDF4400** Outdoor Pedestal Drinking Fountain Hooks into your water supply. Powder coated stainless steel prevents corrosion and keeps it looking good for years. 14"L x 14"W x 40"H
- C. **GWDF4420** Outdoor Bottle Filling Station with Drinking & Pet Fountain Keep both man and beast hydrated on the course with this powder coated stainless steel fountain. 26"L x 31"W x 64"H. This unit can also be ordered as a bottle filling station only, with or without drinking fountain. **\$9,950**
- D. **GWDF7001** Vented & Refrigerated, non filtered stainless steel cabinet Please specify if your application is for indoor or outdoor use. 12"L x 12"W x 38"H may vary. **\$1,327**
- E. **GWDF4405BF** Wall Mount Bottle Filling Station Powder coated stainless steel. 10"L x 19"W x 32"H **\$6,398**
- F. **GW4408** HydroBoost Bottle Filling Station Stainless steel, powder coated. 14"L x 14"W x 64"H **\$8,158**
- G. **GWDF100** Drinking Fountain with Recycled Plastic Cover **\$2,505**
- H. **GWDF4450** Outdoor Drinking fountain with pedestal arm **\$5,742**

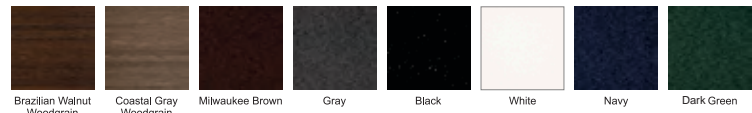

Freestanding Water & Nugget Ice Dispenser
Air cooled condenser. Dispenses nugget ice and water. 425 lb. maximum daily ice production. 325 lb. AHRI certified daily ice production. Stores as much as 25 lbs. of ice. 115v.
GWIM \$16,376



Full Cube Ice Machine w/ Ice Dispenser
470 lb. maximum daily ice production. 375 lb. AHRI certified daily ice production. Air cooled system produces dice ice EasyTouch® display helps user operate the machine. 120 lb Storage. 115v.
GIWIFM \$12,300



Countertop Water & Nugget Ice Dispenser
This unit pairs perfectly with our GW4000 Beverage Station and is our most popular water and ice dispenser. 260 lb. ice production capacity and 225 lb. AHRI certified ice production capacity 12 lb. ice storage capacity. Storage bin can be completely removed for cleaning. Condenser is air cooled. Large removable drip tray with a drain prevents messes. External air filter can be removed for cleaning Touch Free Dispense, 115v
GIWIM \$9,048



Touchless Handle Coffee Dispenser
This simple to clean stainless steel dispenser withstands heavy use without rusting or corroding, and to prevent cross contamination, this unit features a touch less faucet handle treated with an antimicrobial agent. 2 gal. capacity. Mounted on base with drip tray and built in handles. Digital Volume Indicator™
GWCD \$782



4 Gallon Iced Tea Dispenser with Brew-Through Lid
This 4 gallon dispenser utilizes a sump style valve to completely dispense all of your delicious iced tea or juice, leaving no more wasted product to dump down the sink.
GIWT \$168

TEE AREA



TEE AREA

PRICE MATCH GUARANTEE *with Any Major Competitor*

WATER COOLERS



Igloo 54qt. Ice Chest

Made in the USA, this marine grade cooler fits into our GW3000 cooler. Stainless steel, rust resistant screws withstand wet conditions and has a stain & odor-resistant liner.

GW2250 \$226



Large Ice/Cooler Box

This solid recycled plastic unit contains one 54 qt. section and one 108 qt. section of custom food grade liners with drains. Dividers are included if you like to keep items separate. Split hinged lids with lift supports for easy access. Fully sealed and insulated to keep everything cold. 162 qt. total capacity.

GW3700 Tall Model - 41"L x 21"W x 39"H **\$3,118**
GW3701 Low Model - 41"L x 21"W x 22"H **\$3,118**



Ice Chest Enclosures

This popular ice chest houses a 54 qt Igloo cooler and has a hinged lid and sturdy 2x2 frame. 31"L x 20"W x 29"H

GW3000 \$1,153



Double Ice Chest

Double 54qt ice chest totaling 108 qt capacity with food grade liners. Sturdy 2x4 leg construction is a great idea for high traffic areas.

GW3500D Tall Model - 45"L x 21"W x 32"H **\$2,424**
GW3501D Low Model - 45"L x 21"W x 22"H **\$2,424**

Includes two separate 54 qt coolers for a total of 108 qts.

GW3500T Tall Model - 67"L x 21"W x 32"H **\$3,267**
GW3501T Low Model - 67"L x 21"W x 22"H **\$3,267**



Triple Ice Chest

Triple 54qt ice chest totaling 162 qt capacity with food grade liners. Sturdy 2x4 leg construction is a great idea for high traffic areas and locations where multiple items need to be offered.

GW3501T \$3,267

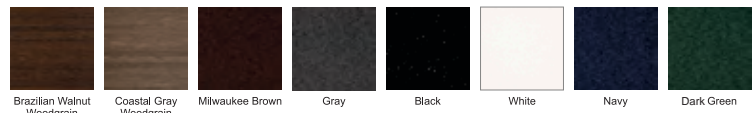

TEE AREA



TEE AREA

PRICE MATCH GUARANTEE *with Any Major Competitor*

WATER COOLERS



Ice Chest Enclosures

Ice Chest & Trash Enclosure 54 qt. Igloo ice chest and 26 gal. trash enclosure. Trash liner and ice chest included.

GW3100 \$1,837



Small Ice/Cooler Box

Includes three split hinged lids for easy access to three separate 54 qt. coolers. 162 qt. capacity. Features all recycled plastic construction and can be configured with short or tall legs. Fully sealed and insulated, it includes a custom food-grade liner with a drain. Dividers are included to keep your items separate. Hinged lids have lift supports for easy access.

GW3500 54 qt. capacity. Tall Model - 23"L x 21"W x 32"H **\$1,228**
GW3501 54 qt. capacity. Low Model - 23"L x 21"W x 22"H **\$1,228**



Tribute Collection 54 qt Ice Chest

This durable ice chest features a food grade liner, a divider to keep items separated, and soft close hinges for ease of use. Fully customizable to suit your specific needs and color preferences, it's perfect for keeping drinks cold and your items organized, whether on the course or at the clubhouse.

29"L x 23"W x 34"H

GW3575 \$1,780



Medium Ice/Cooler Box

Medium Single ice/cooler box can be configured with short or tall legs. All Recycled plastic construction. Custom Food Grade Liner with drain. Dividers are included if you like to keep items separate. Split hinged lids when lift supports for easy access. Fully sealed and insulated to keep everything cold. 206 qt. Capacity.

GW3600 Tall Model - 43"L x 22"W x 35"H **\$2,180**
GW3601 Low Model - 43"L x 22"W x 22"H **\$2,180**

Double Ice Chest Enclosure
This model houses two 54 qt. Igloo Ice chests with dual hinged lids. 58"L x 20"W x 28"H

GW3001 \$2,338

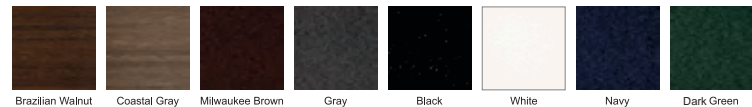

TEE AREA



PRICE MATCH GUARANTEE with Any Major Competitor



STAKES



Red	Purple	White
Yellow	Blue	Dark Green
Gray	Black	Navy
Brazilian Walnut Woodgrain	Coastal Gray Woodgrain	Milwaukee Brown

Stake Color Options



Directional Markers
 Bucket of markers with 4" vinyl cap on recycled plastic 2"x2"x8" post. Delivered to you in quantities of 25 in a handy reusable bucket. Available in any color of recycled plastic. Cap options are green, blue, yellow, white, red and black.
GS2000 \$215

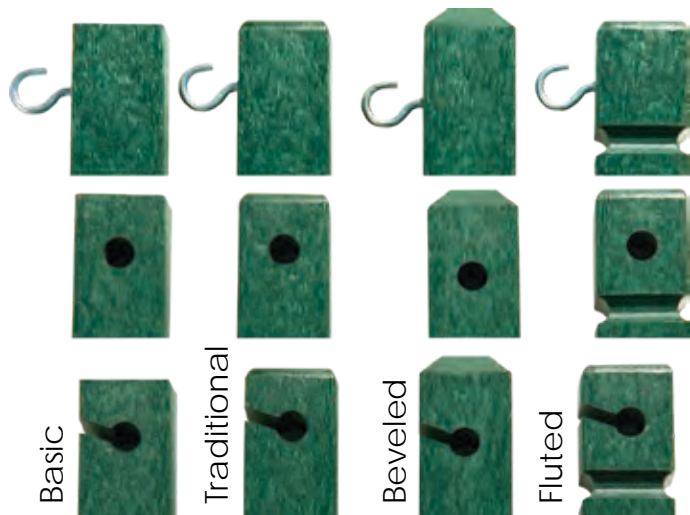

Rope & Chain Stakes
 These 2x2 recycled plastic stakes will not rust or need repainting. Maintenance free and available in a variety of colors and lengths.

GRC100BK	Black 1/4"x1000' Hollow Braid Rope	\$60
GRC100G	Green 1/4"x1000' Hollow Braid Rope	\$60
GRC100GW	Green & white 1/4"x1000' Hollow Braid Rope	\$60
GRC100W	White 1/4"x1000' Hollow Braid Rope	\$60
GRC100Y	Yellow 1/4"x1000' Hollow Braid Rope	\$60



Hazard & OB Stakes

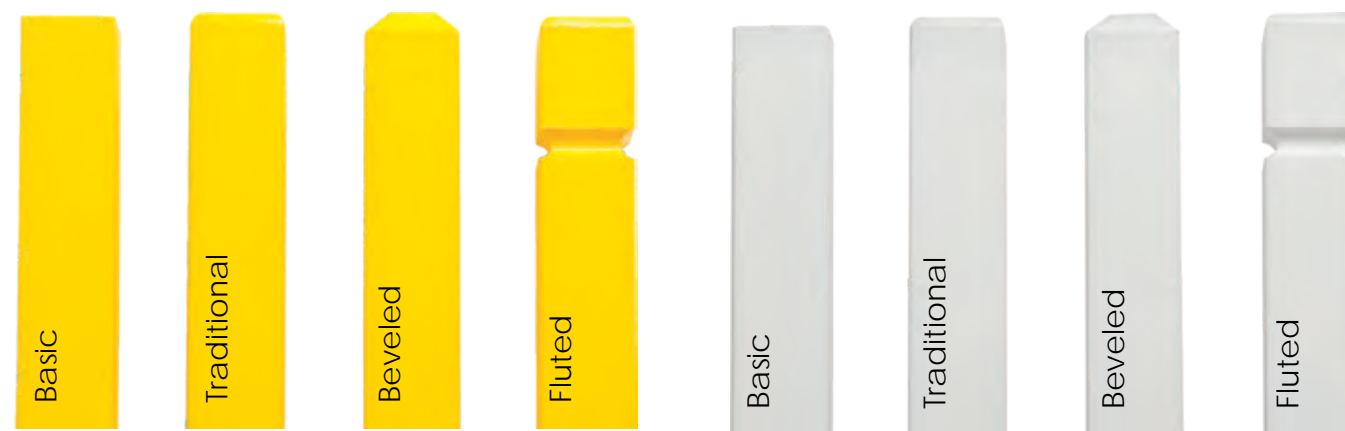

Hazard & OB Stakes

Basic Budget Stake
 When ordering, please specify: color, length, hook, hole or speed slot.
GS1112 2" x 2" x 12" **\$10.50**
GS1118 2" x 2" x 18" **\$12.50**
GS1124 2" x 2" x 24" **\$14**
GS1132 2" x 2" x 32" **\$15.25**
GS1136 2" x 2" x 36" **\$16**

Square Traditional Stake
 When ordering, please specify: color, length, hook, hole or speed slot.
GS1312 2" x 2" x 12" **\$10.50**
GS1318 2" x 2" x 18" **\$12.50**
GS1324 2" x 2" x 24" **\$14**
GS1332 2" x 2" x 32" **\$15.25**
GS1336 2" x 2" x 36" **\$16**

Bevel Top Stake
 When ordering, please specify: color, length, hook, hole or speed slot.
GS1412 2" x 2" x 12" **\$10.50**
GS1418 2" x 2" x 18" **\$12.50**
GS1424 2" x 2" x 24" **\$14**
GS1432 2" x 2" x 32" **\$15.25**
GS1436 2" x 2" x 36" **\$16**

Fluted Stake
 When ordering, please specify: color, length, hook, hole or speed slot.
GS1212 2" x 2" x 12" **\$10.50**
GS1218 2" x 2" x 18" **\$12.50**
GS1224 2" x 2" x 24" **\$14**
GS1232 2" x 2" x 32" **\$15.25**
GS1236 2" x 2" x 36" **\$16**



STAKES



Post Caps

4"x4" Vinyl Caps available on Our 4"x4" Posts
GSC-CAP4x4 \$7

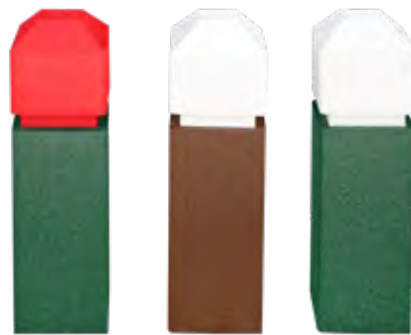

Multi-Color Posts

Can be used in many ways on the course. Use with rope and chain, or as a traffic diverter to keep traffic off designated areas.

When order please specify:
 color, length, hook, hole and top style.

- GS1512M** 4" x 4" x 12" w/ 2 spikes **\$43**
- GS1518M** 4" x 4" x 18" w/ 2 spikes **\$50**
- GS1524M** 4" x 4" x 24" w/ 2 spikes **\$60**

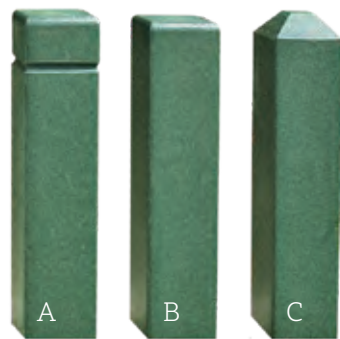

4x4 Rope Posts and Traffic Diverters

Our 4"x4" posts are available with three cut styles on top. A) Fluted; B) Traditional; C) Chamfer. Most popular lengths are 12", 18" and 24", but you can order them in just about any length and we can add your logo.

- GS1512** Rope & chain post 4" x 4" x 12" **\$28**
- GS1518** Rope & chain post 4" x 4" x 18" **\$39**
- GS1524** Rope & chain post 4" x 4" x 24" **\$47**



Standard Recycled Plastic Posts

Posts with the most. Our rugged, maintenance free recycled plastic 4"x4" posts are available in the color of your choice. Order in the stock sizes shown or in any custom length up to 144". Our sign posts also work great as traffic diverters around your course and are available in 4 different top styles.



Decorative Posts

Transform your standard recycled plastic posts from simple to stunning with our decorative tops. Choosing from Capital, Deluxe, or Pyramid styles, you can finish your project with a high-end look while providing essential protection against the elements. Available in Black, White, or Copper to perfectly match your aesthetic.



Decorative Post Options

A - Flat Top 4"x4" Post

GS1501-12	4" x 4" x 12"	\$28
GS1501-18	4" x 4" x 18"	\$39
GS1501-24	4" x 4" x 24"	\$47
GS1501-32	4" x 4" x 32"	\$75
GS1501-36	4" x 4" x 36"	\$78
GS1501-48	4" x 4" x 48"	\$101
GS1501-60	4" x 4" x 60"	\$127
GS1501-72	4" x 4" x 72"	\$170
GS1501-84	4" x 4" x 84"	\$180
GS1501-96	4" x 4" x 96"	\$192

B - Traditional Top 4"x4" Post

GS1502-12	4" x 4" x 12"	\$28
GS1502-18	4" x 4" x 18"	\$39
GS1502-24	4" x 4" x 24"	\$47
GS1502-32	4" x 4" x 32"	\$75
GS1502-36	4" x 4" x 36"	\$78
GS1502-48	4" x 4" x 48"	\$101
GS1502-60	4" x 4" x 60"	\$127
GS1502-72	4" x 4" x 72"	\$170
GS1502-84	4" x 4" x 84"	\$180
GS1502-96	4" x 4" x 96"	\$192

C - Beveled Top 4"x4" Post

GS1503-12	4" x 4" x 12"	\$28
GS1503-18	4" x 4" x 18"	\$39
GS1503-24	4" x 4" x 24"	\$47
GS1503-32	4" x 4" x 32"	\$75
GS1503-36	4" x 4" x 36"	\$78
GS1503-48	4" x 4" x 48"	\$101
GS1503-60	4" x 4" x 60"	\$127
GS1503-72	4" x 4" x 72"	\$170
GS1503-84	4" x 4" x 84"	\$180
GS1503-96	4" x 4" x 96"	\$192

D - Angled Top 4"x4" Post

GS1504-12	4" x 4" x 12"	\$28
GS1504-18	4" x 4" x 18"	\$39
GS1504-24	4" x 4" x 24"	\$47
GS1504-32	4" x 4" x 32"	\$75
GS1504-36	4" x 4" x 36"	\$78
GS1504-48	4" x 4" x 48"	\$101
GS1504-60	4" x 4" x 60"	\$127
GS1504-72	4" x 4" x 72"	\$170
GS1504-84	4" x 4" x 84"	\$180
GS1504-96	4" x 4" x 96"	\$192

Decorative Beveled Top 4"x4" Posts

GS1512FP	4" x 4" x 12" Fluted with Pyramid top	\$57
GS1518FP	4" x 4" x 18" Fluted with Pyramid top	\$70
GS1524FP	4" x 4" x 24" Fluted with Pyramid top	\$79
GS1512CP	4" x 4" x 12" Fluted with Capitol top	\$57
GS1518CP	4" x 4" x 18" Fluted with Capitol top	\$70
GS1524CP	4" x 4" x 24" Fluted with Capitol top	\$79
GS1512FSP	4" x 4" x 12" Fluted with Deluxe top	\$57
GS1518FSP	4" x 4" x 18" Fluted with Deluxe top	\$70
GS1524FSP	4" x 4" x 24" Fluted with Deluxe top	\$79

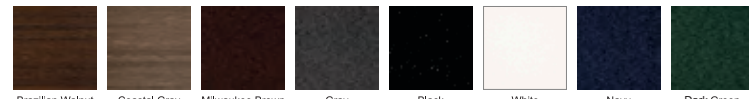



PRICE MATCH GUARANTEE with Any Major Competitor



STAKES Yardage Markers



GREEN/WHITE LETTERS	WHITE/GREEN LETTERS	BLACK/WHITE LETTERS	WHITE/BLACK LETTERS	BLACK/RED LETTERS
BLACK/YELLOW LETTERS	YELLOW/BLACK LETTERS	TAN/GREEN LETTERS	BROWN/WHITE LETTERS	TAN/BROWN LETTERS
RED/WHITE LETTERS	WHITE/RED LETTERS	BLUE/WHITE LETTERS	WHITE/BLUE LETTERS	BROWN/TAN LETTERS



Square Multi-Color Stakes

2" x 2" stakes are manufactured to suit your needs. Many color and length combinations are available. Call to discuss special needs.

- GS1312M 2" x 2" x 12" w/ spike \$21
- GS1318M 2" x 2" x 18" w/ spike \$22
- GS1324M 2" x 2" x 24" w/ spike \$25
- GS1332M 2" x 2" x 32" w/ spike \$26

Red	Purple	White
Yellow	Blue	Dark Green
Gray	Black	Navy
Brazilian Walnut Woodgrain	Coastal Gray Woodgrain	Milwaukee Brown

Stake Color Options



100		100		100	
150		150		150	
200		200		200	
250		250		250	
GM100	GM101	GM110	GM111	GM120	GM121

GM100 8"x12" numbered \$65
GM101 8"x12" plain \$54

GM110 8" numbered \$55
GM111 8" plain \$45
GM120 15" numbered \$106
GM121 15" plain \$97



Striped Stakes

These striped stakes are all 100% plastic lumber construction, NOT vinyl. They can be ordered in any color or length.
GS1332S 2" x 2" x 32" \$64
GS1348S 2" x 2" x 48" \$97

Enter/Exit Stakes

SC100 Enter Stake 2" x 1" x 18" on one spike. \$36.75
SC101 Laminated Plastic 2" x 1" x 18" on one spike. \$36.75

Enter/Exit Signs

Recycled Plastic Lumber, engraved and filled

- GS1012E Enter Stake 2"x2"x12" \$44
- GS1012X Exit Stake 2"x2"x12" \$44
- GS1018E Enter Stake 2"x2"x18" \$47
- GS1018X Exit Stake 2"x2"x18" \$47
- GS1024E Enter Stake 2"x2"x24" \$51
- GS1024X Exit Stake 2"x2"x24" \$51
- GS1512E Enter Stake 4"x4"x12" \$57
- GS1512X Exit Stake 4"x4"x12" \$57
- GS1518E Enter Stake 4"x4"x18" \$70
- GS1518X Exit Stake 4"x4"x18" \$70
- GS1524E Enter Stake 4"x4"x24" \$79
- GS1524X Exit Stake 4"x4"x24" \$79



Vertical Distance Markers

4"W x 24"H on 2 spikes. These markers are great for informing golfers on the course. Made from engraved laminated plastic. They can be engraved with any message of your choice.
GM120V \$71

Distance Marker

Driving Range Distance Marker
Available in aluminum, bronze or laminate.
GSDM100 Call For Quote

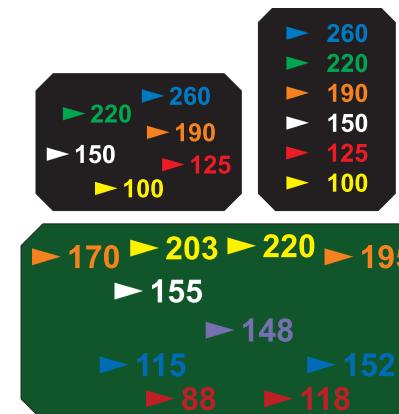
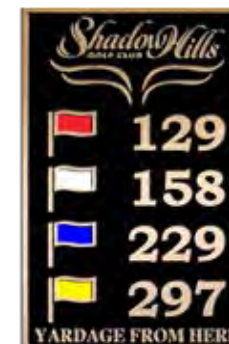

Yardage and Fairway Plain Posts

- GM200-32 Plain 4" x 4" x 32" \$82
- GM200-48 Plain 4" x 4" x 48" \$103
- GM200-60 Plain 4" x 4" x 60" \$131



Yardage and Fairway Numbered Posts

- GM200N-32 Numbered 4" x 4" x 32" \$114
- GM200N-48 Numbered 4" x 4" x 48" \$133
- GM200N-60 Numbered 4" x 4" x 60" \$154

- GM200S 4" x 4" x 12" ground sleeve \$36
- STD09790 Recycled Plastic 12" Ground Anchor for 4"x4" Posts \$75



FLAGS

PRICE MATCH GUARANTEE with Any Major Competitor

FLAGS Embroidered

Embroidered Solid Regulation - \$41

Flags of Distinction

Flags are among our most popular products, and for good reason. First and foremost, we make our flags in the U.S.A. out of 400 denier nylon, which is twice as strong as the industry standard. Custom embroidering is performed in house, and we also offer a silk screening service so you can get a personalized product built to your exact specifications.

Moreover, our flags are built to last. In addition to the highest quality fabric available, our flags are zig-zag and triple stitched, with reinforced corners to prevent fraying in sustained winds. They're also mildew and UV resistant, so they'll stay looking new for years. Finally, because we build our flags in house, custom work can be turned around in two weeks or less and priority service is available. Please call for details.

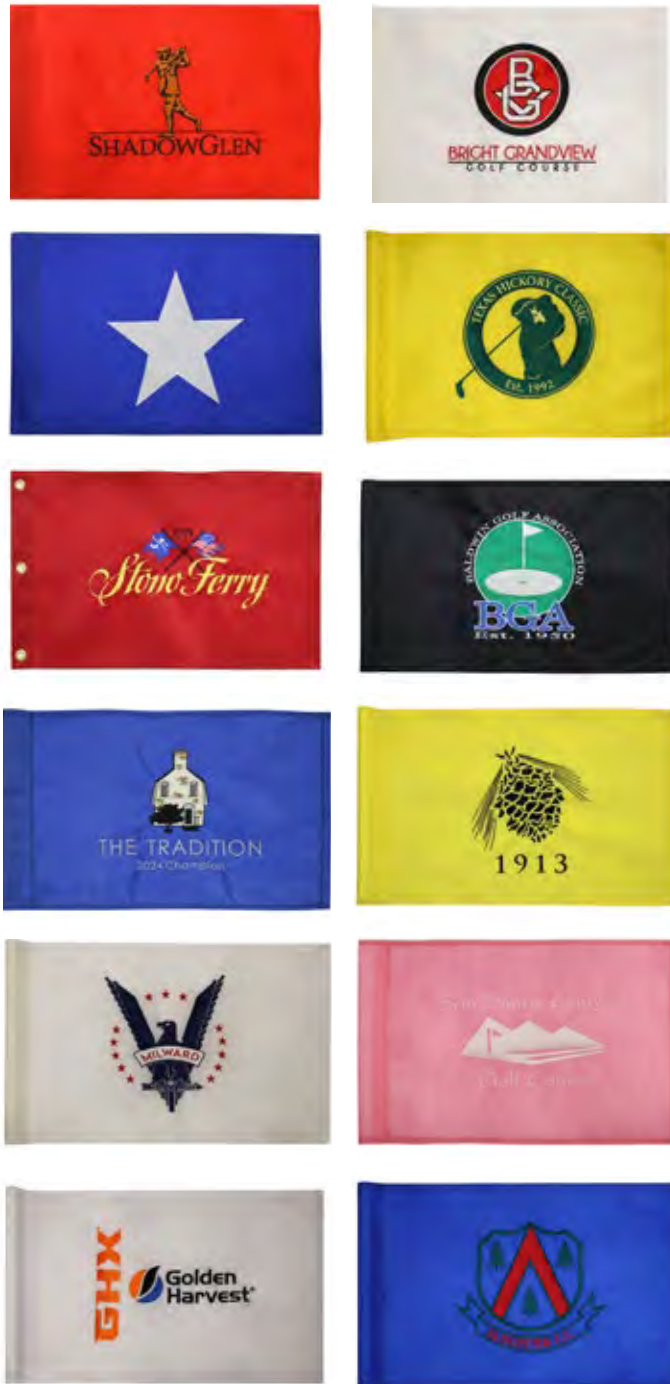

No Art Charges for Embroidery or Silk Screen Flags
Buy 27 GET 9 FREE

Embroidered Solid w/ Handle and Border Regulation - \$49.50

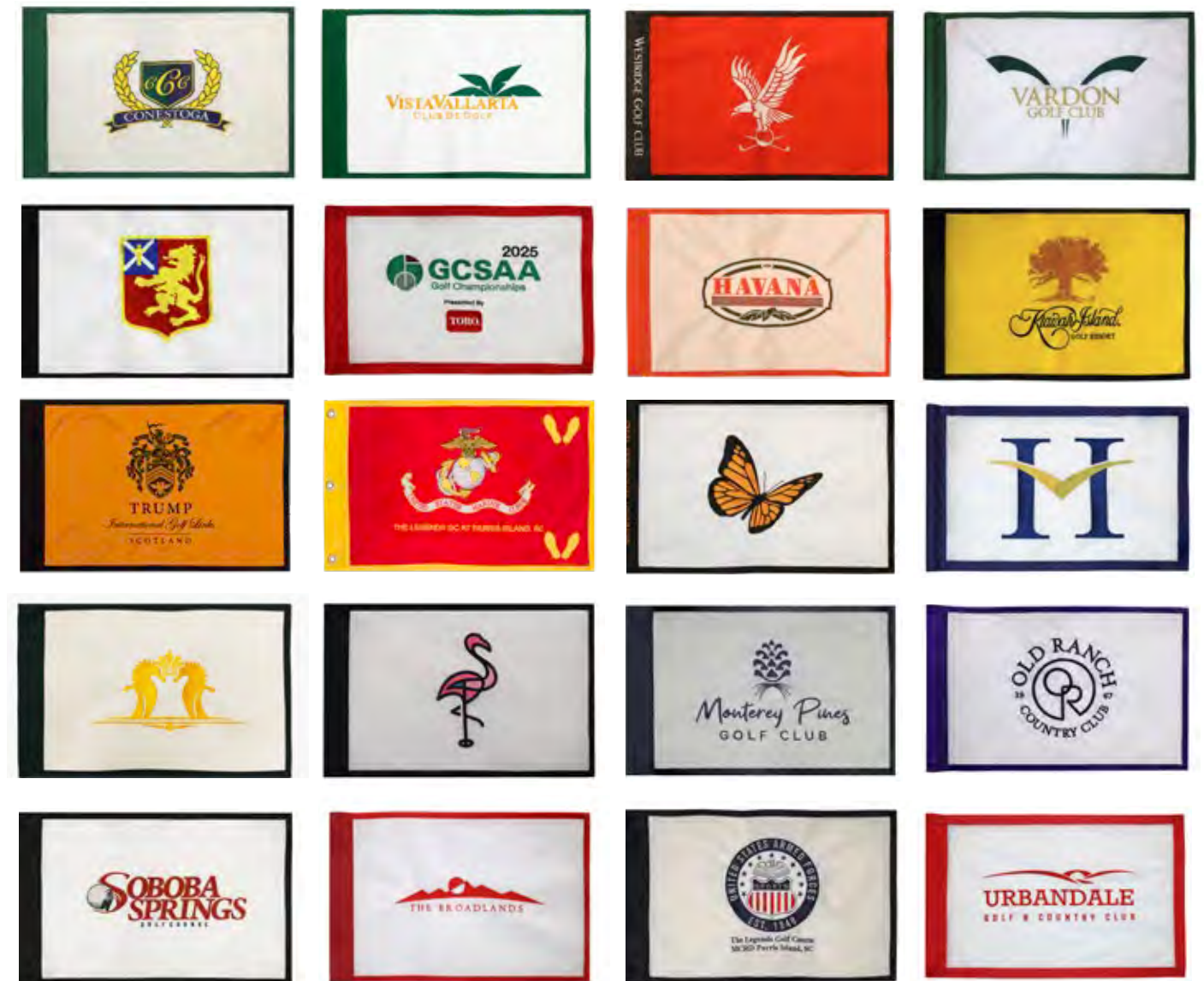

FLAGS



FLAGS

PRICE MATCH GUARANTEE *with Any Major Competitor*

FLAGS Embroidered

Embroidered Handle Only Regulation - \$45.25



Embroidered Logo with Numbers Regulation - \$48



Embroidered Checkered Regulation - \$46



No Art Charges for Embroidery or Silk Screen Flags
Buy 27 GET 9 FREE

Embroidered Logo with Reflective Handle - \$49

Reflective material handles allow for range finders to accurately gauge the pin's distance to a golfer



Embroidered Handle Only Regulation - \$48

Embroidered Logo
Add Name on Handle



Embroidered Diagonal Regulation - \$44



FLAGS



FLAGS

PRICE MATCH GUARANTEE with Any Major Competitor

FLAGS

Embroidered / Silk Screen

Embroidered Double Sided Solid Practice Green Flags - \$48.25
Embroidered Double Sided Handle/Border Practice Green Flags - \$56.75



Embroidered Solid Practice Green Flags - \$27.75

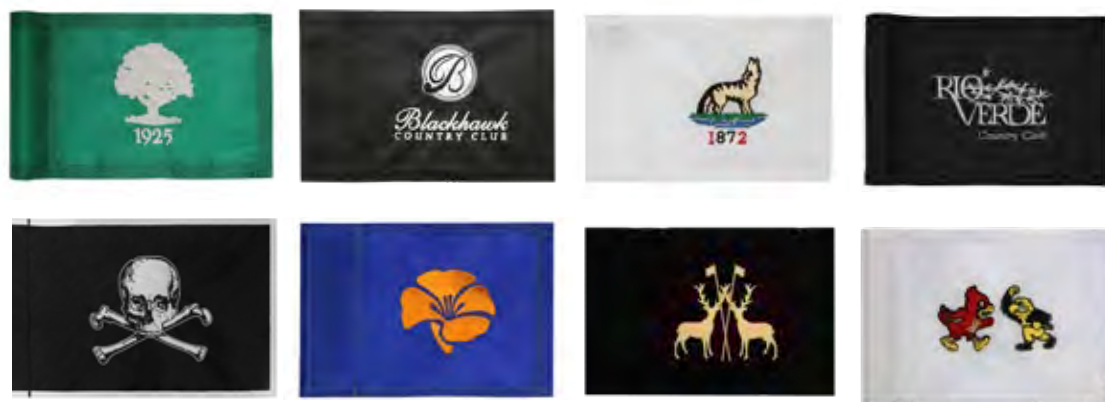

Embroidered Solid w/ Handle & Border - \$36.25
Embroidered Solid w/ Handle only - \$32



No Art Charges for Embroidery or Silk Screen Flags
Buy 27 GET 9 FREE

Embroidered Tee Towels - \$354 per dozen



Custom Flags - Call for Quote

Let us Design Your Perfect Flag
Custom Flags Available



Silk Screen Practice Green

Silk Screen Solid Practice Green Pricing

- 1 Color \$19
- 2 Colors \$20.50
- 3 Colors \$23.50
- 4 Colors \$26.25
- 5 Colors \$29.25
- 6 Colors \$33.75

Silk Screen Solid w/ Handle and Border Practice Green Pricing

- 1 Color \$27.50
- 2 Colors \$29
- 3 Colors \$32
- 4 Colors \$34.75
- 5 Colors \$37.75
- 6 Colors \$42.25

Silk Screen Solid w/ Handle Practice Green

- 1 Color \$23.25
- 2 Colors \$24.75
- 3 Colors \$27.75
- 4 Colors \$30.50
- 5 Colors \$33.50
- 6 Colors \$38



FLAGS



FLAGS

PRICE MATCH GUARANTEE with Any Major Competitor

FLAGS Silk Screened



No Art Charges for Embroidery or Silk Screen Flags
Buy 27 GET 9 FREE

Silk Screen Solid Regulation



Silk Screen Solid Regulation Pricing

- 1 Color \$26.25
- 2 Colors \$29.25
- 3 Colors \$32.25
- 4 Colors \$33.75
- 5 Colors \$36.50
- 6 Colors \$40



Silk Screen Solid w/ Handle and Border Regulation

Silk Screen Solid w/ Handle & Border Regulation Pricing

- 1 Color \$34.75
- 2 Colors \$37.75
- 3 Colors \$40.75
- 4 Colors \$42.25
- 5 Colors \$45
- 6 Colors \$48.50



Silk Screen Checkered Regulation

Silk Screen Checkered Regulation Pricing

- 1 Color \$40
- 2 Colors \$42
- 3 Colors \$44
- 4 Colors \$46
- 5 Colors \$48
- 6 Colors \$50



Silk Screen Diagonal Regulation

Silk Screen Diagonal Regulation Pricing

- 1 Color \$37
- 2 Colors \$39
- 3 Colors \$41
- 4 Colors \$43
- 5 Colors \$45
- 6 Colors \$47

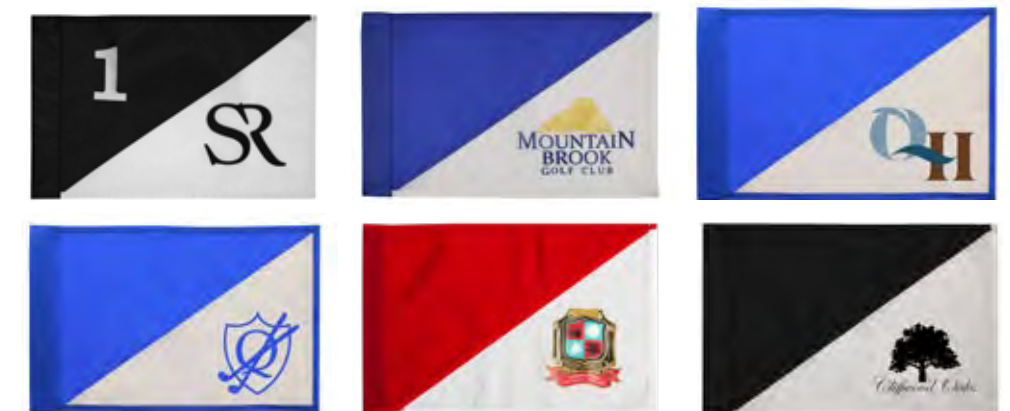

FLAGS



FLAGS

PRICE MATCH GUARANTEE *with Any Major Competitor*

FLAGS

Embroidered / Silk Screened

Numbered Solid Flags

Regulation
 Embroidered \$41
 Silk Screen \$26.25
 Practice Green
 Embroidered \$27.25
 Silk Screen \$19



Plain Practice Green Flags - \$10



Plain Checkered Practice Green Flags - \$17.50



Plain Checkered Regulation Flags - \$33

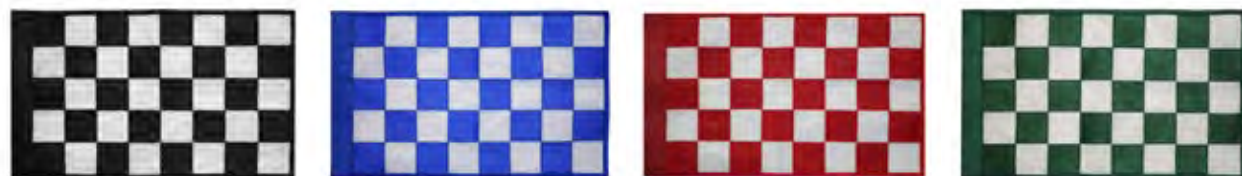

No Art Charges for Embroidery or Silk Screen Flags

Buy 27 GET 9 FREE

Plain Handle and Border Flags

Plain Handle & Border Regulation Flags \$21.75
 Plain Handle & Border Practice Flags \$18.50



Plain Regulation Flags - \$13.25



Plain Range Flags - \$30.75



American Flags

Large American Flag
 Premium Heavy Duty Outdoor Flags with Brass Grommets

GRFUSA3X5	3'H x 5'W	\$75
GRFUSA4X6	4'H x 6'W	\$99
GRFUSA5X8	5'H x 8'W	\$160
GRFUSA6X10	6'H x 10'W	\$235
GRFUSA10X15	10'H x 15'W	\$220



American Flag Replica for Flagstick

STD22466T	Set of 9	\$178
STD20987	Single 3/8" rods	\$9.75
STD20787	Single 1/2" rods	\$10.25

FLAGS



PRICE MATCH GUARANTEE *with Any Major Competitor*

FLAGSTICKS

Royaline Flag Sticks

STD26995	White, 5' [1.5m]	\$23
STD26100	White, 7.5' [2.3m]	\$26
STD26915	White/Red Stripe 5' [1.5m]	\$28
STD26101	White, 7.5' [2.3m]	\$29
STD26102	White/Blue/Red Stripe, 7.5' [2.3m]	\$29
STD26103	White/Black British Stripe, 7.5' [2.3m]	\$29
STD26104	White/Blue Stripe, 7.5' [2.3m]	\$29
STD26105	White/Green Stripe, 7.5' [2.3m]	\$29
STD26106	White/30" Black Bottom, 7.5' [2.3m]	\$29
STD26107	Pink, 7.5' [2.3m]	\$35
STD26108	White/Pink Stripe, 7.5' [2.3m]	\$29
STD26110	Yellow 7.5' [2.3m]	\$26
STD26111	Yellow/Black Stripe, 7.5' [2.3m]	\$29
STD26112	Yellow/30" Black Bottom, 7.5' [2.3m]	\$29
STD26120	Red, 7.5' [2.3m]	\$26
STD26121	Red/ White Strip e, 7.5' [2.3m]	\$29
STD26130	Black, 7.5' [2.3m]	\$26
STD26140	Optic Yellow, 7.5' [2.3m]	\$32
STD26998	White, 8' [2.4m] & 10' [3m]	\$29
STD26988	Yellow, 8' [2.4m] & 10' [3m]	\$29
STD26315	Tournament Flag Stick Woodgrain 7 1/2' [2.3m]	\$175



Vinyl Guard

Vinyl Guard protects your flag stick handles ensuring long lasting use.

JF-VG-30-FS-1000	White Vinylguard 250' Roll for 1" Flagsticks	\$329.99
JF-VG-30-FS-7550B	Black Vinylguard 250' Roll for 3/4" Tapered Flagsticks	\$305.99
JF-VG-30-FS-7550G	Green Vinylguard 250' Roll for 3/4" Tapered Flagsticks	\$305.99
JF-VG-30-FS-7550R	Red Vinylguard 250' Roll for 3/4" Tapered Flagsticks	\$305.99
JF-VG-30-FS-7550W	White Vinylguard 250' Roll for 3/4" Tapered Flagsticks	\$305.99
JF-VG-30-FS-7550Y	Yellow Vinylguard 250' Roll for 3/4" Tapered Flagsticks	\$305.99

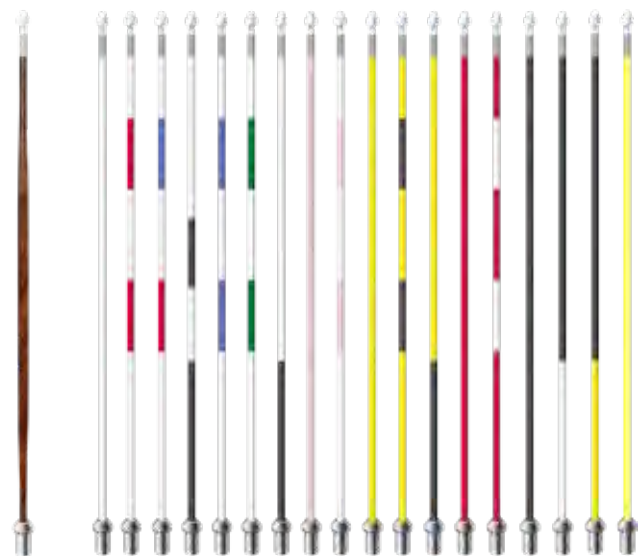

Laser Tournament Flag Sticks

5 prism machine drilled and embedded into the flag stick give 360-degree coverage. All laser golf measuring devices will work seamlessly. Comes standard with our Smart-Fit Pro ferrule. Fiberglass construction. Length 7.5' [2.3m] 1/2" [1.3 cm] diameter at both tip and ferrule 3/4" [1.9 cm] diameter at the center

STD26316	White	\$109
STD26317	Yellow	\$109
STD26318	Black/White, British stripe	\$114
STD26319	Woodgrain	\$225



Tournament Flag Sticks

STD26300	White, 7.5' [2.3m]	\$60
STD26301	White/Black British Stripe, 7.5' [2.3m]	\$66
STD26302	White/Red British Stripe 7.5' [2.3m]	\$66
STD26303	White/Green British Stripe, 7.5' [2.3m]	\$66
STD26304	White/30" Black Bottom, 7.5' [2.3m]	\$66
STD26305	White/RED, 4 red stripes 7.5' [2.3m]	\$66
STD26310	Yellow, 7.5' [2.3m]	\$66
STD26311	White/Black British Stripe, 7.5' [2.3m]	\$66
STD26314	White/30" Black Bottom, 7.5' [2.3m]	\$66



Flag Stick Holder

Our 2"x2"x24" recycled plastic flag stick holder has a V Notch at the top and prevents the flag from touching the ground which keeps it clean and dry.

GS1324V-RWB	\$28
GS1324V-R	\$16
GS1324V-W	\$16
GS1324V-G	\$16



Junior Tournament Rods

STD20200	White, Solid rod only	\$22
STD20225	Yellow, Solid rod only	\$22
STD20201	Black/White, Striped rod only	\$27
STD20202	Red/White, Striped rod only	\$27
STD20203	Green/White, Striped rod only	\$27
STD20226	Black/Yellow, Striped rod only	\$27



Double Sided Proximity Marker

Laminate Proximity Marker Sign with verbiage of your choice on one side and a 5"x7" Dry Erase Board with printed lines and numbers on the back. Add your logo to personalize. Sign measures 7"x12"x1/2" and is mounted on a 2"x2"x18" stake.

GTM2500 - \$99



Cast Aluminum Practice Green Markers

The resiliency and functionality of cast aluminum. Comes plain but a numbered decal or your logo can be added. Fits 3/8" practice green rods and targets. Head Only

STD20532	White	\$8.50
STD20533	Yellow	\$8.50
STD20534	Red	\$8.50
STD20535	Green	\$8.50
STD20536	Blue	\$8.50
STD20537	Black	\$8.50
STD20531	Woodgrain	\$33
Numbered Decals 1-9		
STD20541	White Set	\$32
STD20561	Red Set	\$32
STD20581	Black Set	\$32
LogoDecal	Individual Decals	\$3.50



Numbered Practice Green Mennant Sets

Solid Pennant Head Only		
STD20383	White	\$7.50
STD20583	Black	\$7.50
Solid Pennant Head Only		
STD20384-1	White/Red Numbers	\$7.50
STD20484-1	White/Green Numbers	\$7.50
STD20584-1	Black/Yellow Numbers	\$7.50
Sets 1-9		
STD20391	White Head/Red Rod	\$235
STD20491	White Head/Green Rod	\$235
STD20591	Black Head/Yellow Rod	\$235
Sets 10-18		
STD20390	White Head/Red Rod	\$235
STD20490	White Head/Green Rod	\$235
STD20590	Black Head/Yellow Rod	\$235



GREENS & GROUNDS



GREENS



Metal Base

Solid metal base for practice green rod. 3 5/8" Diameter x 1 1/2" Height with an Opening of 1/4"

- STD20322 Chrome \$6.75
- STD20523 Black \$7.75



Knobs for Practice Green Flag Sticks

New title Knobs for Practice Green Flag Sticks

- STD20822 Practice Green Rods - 3/8" \$2.50
- STD20522 Junior Tournament Rods - 1/2" \$3.50



Ferrules

Traditional Ferrule

Perfect for the STD18303 Cup.

STD26517 \$8

Smart-Fit Pro Ferrule

16 tapered flanges seat the ferrule and flag stick perfectly with the Smart-Fit Cup. Comes standard on all flag stick orders and works great on all styles of cups.

STD26512 \$8



SMART-FIT™ 360 Ferrules

Locks into place with any of our ST 2000 Cups [no leaning or twisting]. Concave grooves and smaller top diameter decrease surface contact reducing any sticking to debris and allows for more downward movement of debris to get away from the ferrule and cup contact points. Fits all competitor's cups.

STD26515 \$8



Laser Reflector

Tournament Laser Reflector

Fits over our Tournament and 1" Pro Tournament flag sticks. Five glass prism pod design maximizes reflectivity, no dead spots

STD26610 \$47

Laser Reflector

New five glass prism pod design maximizes reflectivity, leaving no dead spots.

STD26600 \$50

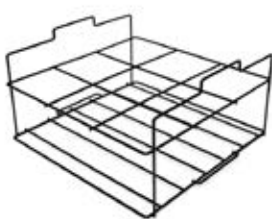

Cup Caddy

Handy for maintaining, storing and rotating cups.

STD18990 \$70



Hole In White

The long lasting application yields over 80 holes per can, and is easily applied.

- JF-HW-SS1 Case of 12 Cans of White Paint \$149
- JF-HW-PT2 Case of 6 Cans of Pink Paint \$104
- JF-HW-EV1 Case of 6 Cans of Evergreen Paint \$89
- JF-HW-TL1 Applicator Tool \$81
- JF-HW-CP1 Cup Protector \$75



E-ZEE White

Clean, crisp white holes made quick and easy! Built in shield protects cup and green from over spray. Improved formula for a brighter white tour grade finish. No purging required. One piece patented design. Starter kit includes tool and one case of paint

- STD55500 Starter Kit \$155
- STD55600 E-ZEE White Tool \$60
- STD55700 Case of 6 paint cans \$105



Pinpoint Cup Changer

Easily remove and place cups without bending over. Set cups without damaging cup edges or leaving indents on the turf. Adjust ferrule height with set screw for perfect cup depth. Both a cup puller and setter.

STD33300 \$129



Cup Hook

Simple and easy to remove any style of cup

STD33200 \$11



ST2000 SMART-FIT™ CUP

	Hybrid Cup	Aluminum Cup	Pink cup	Plastic Cup	Price
Single Cup	N/A	N/A	N/A	STD18222	\$14
Single Cup	STD18444	N/A	N/A	N/A	\$24
Single Cup	N/A	STD18333	STD18333P	N/A	\$37
Set of 18 Cups +1 Cup Setter	N/A	STD18338	N/A	N/A	\$657

Aluminum

Plastic

Hybrid



Magnatech Budget Cup

	Product #	Price
Single Cup	STD18410	\$26
Set of 18 Cups +1 Cup Setter	STD18418	\$459



Riji Cup

	Product #	Price
Single Cup	STD18200	\$9.50

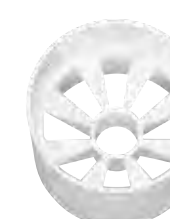

Plastic Practice Green Cup

	Product #	Price
Single Cup	STD18100	\$7



Aluminum Cup

	White Cup	Pink cup	Price
Single Cup	STD18303	STD18303P	\$36
Set of 18 Cups +1 Cup Setter	STD18308	N/A	\$639



Sand Green Cup

	Product #	Price
Single Cup	STD18400	\$88



Aluminum Practice Green Cup

	Product #	Price
Single Cup	STD18150	\$21



Special Event Cup

	White Cup	Pink cup	Price
8" Diameter Plastic [3" high]	STD18775	N/A	\$15
6" Diameter Plastic [6" high]	STD18600	STD18600P	\$58
8" Diameter Steel [3" high]	STD18700	STD18700P	\$58
8" Diameter Steel [6" high]	STD18710	N/A	\$63

GREENS & GROUNDS



GREENS



Deluxe Metal Cup Setter

Set cups without damaging cup edges or leaving indents on the turf. Adjust ferrule height for perfect cup depth.

STD30200 \$89



Cup Saver Ball Retriever

Retriever connects to the bottom of the flagstick with a "snap in place" mechanism. Lift flagstick up and golf balls come up with it. 1/2" Diameter

STD26550 \$6



PVC Turf Align Tool

Roll cup edges smooth when plugging old holes 7" long x 1.6" D

STD16157 \$5.50



Turf Align Pro

Wood dowel with metal needle-nose. Dowel used to smooth and align the plug with the existing turf. Needle-nose spike helps pull up the plug or surrounding turf to align properly. 11" Long

STD33100 \$22



Standard Hole Reduce

Sits flush on top of the cup to reduce size by 1". Made from a rubber textured material that has UV stabilizers and colorfast throughout. 1"H x 4 3/16"D

STD18010 \$7



Flex Putt Target

Made from impact resistant polymer. Easily place around a putting green for tournament practice.

STD18340 \$7.50



Cup Setter

Sets cups to USGA specs below the green. Flattens crowning from hole cutters. Minimizes damage to the rims of aluminum cups.

STD30100 \$12



Hole Target Ring

White plastic hole target ring sits above the cup for added visibility. Use Cup Setter to install ring. 4.25" Diameter

STD18020 \$4.50

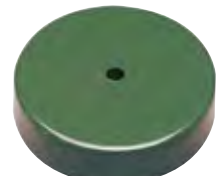

Powder-Coated Cup Cover

4 1/4" cover is powder-coated steel 6" and 8" covers are powder-coated aluminum. Sits flush with the green when cup is recessed 1".

STD18500 4 1/4" Cover \$14
STD18650 6" Cover \$32
STD18750 8" Cover \$36



Standard Cup Cover

Sits on top of the cup, flush with the green when cup is recessed 1"

STD18510 \$7.25



- A. Tingly One Size Rain Poncho, Clear, Olive or Orange
JF-T-P68800 Clear \$7.50
JF-T-P68808 Olive Drab \$7.50
JF-T-P68809 Orange \$7.50
- B. Helly Hansen Rain Gear Mandal Jacket.
JF-HH-70129 Sizes XS-6X \$52
- C. Helly Hansen Rain Gear Mandal Bib
JF-HH-70529 Sizes XS-6X \$52
- D. Helly Hansen Rain Gear Mandal Pants.
JF-HH-70429 Sizes XS-4X \$50
- E. Tingly Storm-Champ 2 Piece Suit, Forest Green.
JF-T-S66211 Sizes S-3X \$71.94
- F. Tingly 48" Industrial Work Coat, Yellow.
JF-T-C53217 Sizes M-XL \$27.90
JF-T-C53217 Size 2X \$28.71
- G. Tingly Comfort-Tuff 2 Piece Suit, Yellow or Blaze Orange.
JF-T-63217 Sizes S-3X \$42.89
- H. Gen-Nex® Professional Grade Hooded Coveralls have a higher grade of protection against particulates. These disposable coveralls are a cost effective solution to protect garments from debris, paint and dust. Made with a cloth-like fiber. Gen-Nex® coveralls include elastic ankles and wrists. Meets ANSI/ASTM F903-10 chemical penetration test for solvent based paints.
JF-SAS-6992 Size Med, 25 Per Case \$107
JF-SAS-6993 Size Large, 25 Per Case \$107
JF-SAS-6994 Size XL, 25 Per Case \$107
JF-SAS-6995 Size 2XL, 25 Per Case \$107
JF-SAS-6996 Size 3XL, 25 Per Case \$107
JF-SAS-6997 Size 4XL, 25 Per Case \$107
JF-SAS-6998 Size 5XL, 25 Per Case \$107
- I. Tingly Rubber Classic Fit Overshoes, Available in Original, Narrow Fit or Wide Fit with a rein forced heel and toe.
JF-T-2300 Sizes S-2x \$32.09
- J. Tingly Profile Safety Toe Knee Boot
JF-T-51254 Sizes 3-14 \$56.23
- K. Tingly Flite Mid-Calf Safety Toe Boot. Lightweight upper, cushioned heel, slip-resistant nitrile rubber outsole and composite toe.
JF-T-26226 Sizes 4-15 \$125.63
- L. Tingly Rubber Classic Fit 10" Overshoe. Natural rubber overshoes easily stretch over work shoes with a reinforced heel and toe.
JF-T-1400 Sizes S-3X \$46.72



MAINTENANCE

PRICE MATCH GUARANTEE *with Any Major Competitor*

MAINTENANCE SUPPLIES



- A. **JF-U-3M6500** Mask protects in extreme conditions for demolition and sanding. Cool Flow™ valve reduces heat and moisture for easier breathing **\$49**
- B. **JF- HH-70129** Impact Resistant polycarbonate shield with ratchet sizing adjustment **\$18**
- C. **JF-U-8610** N95 Industrial Respirator Meets NIOSH N95 standards, box of 20 **\$34**
- D. **JF-SAS-7165** Standard Back Support Belt, 5 sizes of S-2X Available. **\$14**



Foam Ear Plugs
Individually packaged, preshaped foam ear plugs confirm to the inner ear canal.

JF-SAS-6100 Dispenser Box with 200 Uncorded Pairs **\$33**
JF-SAS-6101 Dispenser Box with 100 Corded Pairs **\$31**

Sun Protection Helmets
Good for protecting against the weather elements and the sun's harmful rays.

- H100T** Tan helmet **\$29**
- H100TL** Tan helmet w/ logo **\$34**
- H100W** White helmet **\$29**
- H100WL** White helmet w/ logo **\$34**

Shoe Covers

- Durable, waterproof CPE material
- Textured surface for better grip
- Easy to put on and remove
- Elastic opening for secured fit
- Keeps shoes, boots and worksites clean

JF-SAS-6884-06 6 Pairs **\$4.75**
JF-SAS-6884-40 40 Pairs **\$27.25**



Traffic Safety Cones - Orange

- 100% PVC injection molded cone
- Cleated base allows firm grip to the road
- Superior flexibility in any kind of adverse weather condition
- Reflective bars on orange cones provide wide angle reflectivity
- Collapsible orange cone condenses down flat for easy transport

JF-SAS-7500-12 12" sport cone **\$8.75**
JF-SAS-7500-18 18" cone **\$12.50**
JF-SAS-7501-18 18" w reflective bars **\$15.50**
JF-SAS-7522-18 18" collapsible **\$17.75**
JF-SAS-7500-28 28" cone **\$17.50**
JF-SAS-7501-28 28" w reflective bars **\$22.50**
JF-SAS-7501-36 36" w reflective bars **\$34.95**

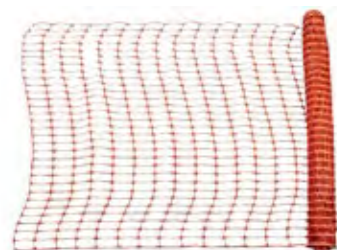

Barrier Fence 4'x100'
HiViz Orange

- 4' H x 100' W
- Ideal for off limits and hazardous areas
- Quick and easy set-up
- Portable high visibility polypropylene mesh barrier
- Economical fencing

JF-SAS-7590-100 **\$36.25**



- A. Jersey Knit Maxiflex Glove Nitrile dots for better grip. Used for general purpose applications.
JF-U-34-874 Sizes M-2XL Box of 12 **\$105**
- B. MX Pro-Tool Mechanics Gloves for gripping power and protection against minor scrapes.
JF-SAS-6652 MX Pro Tool Mechanic's Gloves Size Med, Box of 12 **\$84**
JF-SAS-6653 MX Pro Tool Mechanic's Gloves Size Large, Box of 12 **\$84**
JF-SAS-6654 MX Pro Tool Mechanic's Gloves Size XL, Box of 12 **\$84**
JF-SAS-6655 MX Pro Tool Mechanic's Gloves Size 2XL, Box of 12 **\$84**
- C. Raven Powder Free exam grade nitrile gloves, textured, 7 mil non latex
JF-SAS-66481 Case of 10 Boxes, Qty. 100/ box - Medium **\$229.90**
JF-SAS-66482 Case of 10 Boxes, Qty. 100/ box - Large **\$229.90**
JF-SAS-66483 Case of 10 Boxes, Qty. 100/ box - X-Large **\$229.90**
JF-SAS-66484 Case of 10 Boxes, Qty. 100/ box 2X-Large **\$229.90**
- D. Raven Powder Free exam grade nitrile gloves, textured fingertips, 7 mil non latex
JF-SAS-66516 Case of 10 Boxes, Qty. 100/ box Small **\$209.90**
JF-SAS-66517 Case of 10 Boxes, Qty. 100/ box - Medium **\$209.90**
JF-SAS-66518 Case of 10 Boxes, Qty. 100/ box - Large **\$209.90**
JF-SAS-66519 Case of 10 Boxes, Qty. 100/ box - X-Large **\$209.90**
JF-SAS-66520 Case of 10 Boxes, Qty. 100/ box 2X-Large **\$209.90**
- E. Leather Unlined Driver Gloves for general protection Standard grain cowhide driver unlined leather, priced individually.
8201S Size S, 12 per box **\$48**
8201M Size M, 12 per box **\$48**
8201L Size L, 12 per box **\$48**
8201XL Size XL, 12 per box, shirred elastic back, straight thumb **\$48**
8201XXL Size 2XL, 12 per box, shirred elastic back, straight thumb **\$48**

- A. Lined Leather Driver Glove for general protection Sizes Standard grain cowhide driver unlined leather, priced individually.
JF-CRD-8245S Box of 12 **\$83**
JF-CRD-8245M Box of 12 **\$83**
JF-CRD-8245L Box of 12 **\$83**
JF-CRD-8245XL Box of 12 **\$83**
JF-CRD-82452X Box of 12 **\$83**
- G. PVC Chemical 13" Textured Gloves, Puncture resistant for spraying. Sold in pairs of 12
JF-SAS-6552 Medium **\$7.25**
JF-SAS-6553 Large **\$7.25**
JF-SAS-6554 X-Large **\$7.25**
- H. Chemical Spray Nitrile 13" Textured Gloves Puncture resistant for spraying. Sold in box of 12 pairs.
JF-SAS-6532 Medium **\$54**
JF-SAS-6533 Large **\$54**
JF-SAS-7163 X-Large **\$54**
- I. Astro-Grip Gloves Powder free exam grade nitrile gloves, high-visibility orange color, 3D Cube embossed surface.
JF-SAS-66472 Case of 10 Boxes, Qty. 100/ box - Med. **\$229.90**
JF-SAS-66473 Case of 10 Boxes, Qty. 100/ box - Lrg. **\$229.90**
JF-SAS-66474 Case of 10 Boxes, Qty. 100/ box -XL **\$229.90**
JF-SAS-66475 Case of 10 Boxes, Qty. 100/ box - 2X **\$229.90**
- J. Leather Palm Work Glove, Cotton Top with leather palm and index finger.
JF-SAS-670-6529 One Size Fits All Per Dozen **\$75**



PEM Matting

PEM High Traffic Matting is the perfect slip resistant surfacing solution for golf courses with high amounts of foot traffic.

- Porous construction eliminates standing water
- Allows for moisture evaporation eliminating algae growth
- Trims easily with razor knife for custom installations
- Excellent weatherability: -35 F - 180 F
- Cleans easily with sweeping or by hose
- Reduces the risk of slippage
- Easily rolls up for convenient storage and transportation
- Able to withstand high levels of traffic

Colors Available: Hunter Green, Brown, Black, Red, Gray, Blue, and Sandstone. Custom Sizes Available

JF-PEM-7774 2' x 25' **\$381** per roll
JF-PEM-7775 3' x 25' **\$559** per roll
JF-PEM-7776 6' x 25' **\$1,118** per roll

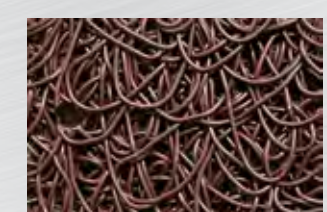
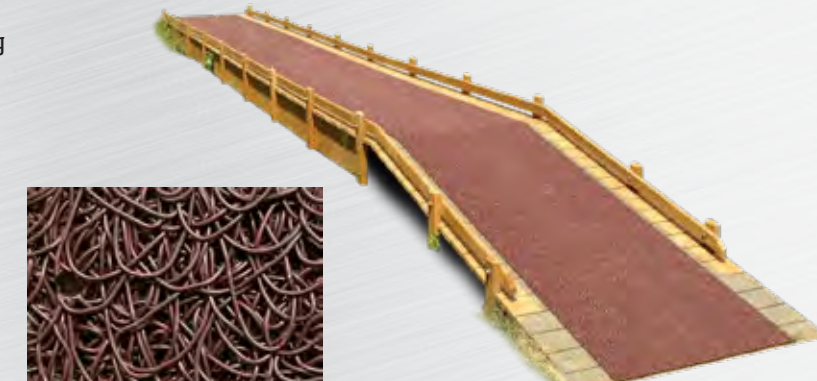

MAINTENANCE



MAINTENANCE

PRICE MATCH GUARANTEE *with Any Major Competitor*

DRAG MATS BUNKER RAKES



Vinyl Guard

Vinyl Guard protects your bunker rake handles ensuring long-lasting use.

JF-VG-30-RH-10000G Green 250' Roll for 1" Rake Handle Roll **\$329.99**

JF-VG-30-RH-1000B Brown 250' Roll for 1" Rake Handle Roll **\$329.99**

PLACE RAKE IN BUNKER

Rake Replacement Decals - Pack of 12

STD11000 "Place Rake in Bunker" **\$10**

PLACE RAKE OUTSIDE BUNKER

STD11050 "Place Rake Outside Bunker" **\$10**

PLEASE RETURN RAKE TO CART

STD11025 "Please Return Rake to Cart" **\$10**

Coco Fiber Drag Mats

Spreads top dressing with a soft, smooth touch. Perfect for all playing surfaces. Tough, resilient coir fibers 1 1/4" bond to vinyl-reinforced backing. 10' chain hooks up to any vehicle

STD53000 4'x6' **\$900**

STD53050 3'x5' **\$695**

Coco Fiber Drag Mop

Uses the same material as our Coco Drag Mat. Comes with a 66" aluminum, straight handle and double twisted gusset for strength.

STD53060 25"x18" **\$265**

Keystone Mats

Perfect for spreading sand and seed on your greens. Rolls up for easy cleaning and storage. Pull rope attached to 13 gauge galvanized steel rods.

JF-KS-M1040X24A 40"W x 7'L **\$650**

JF-KS-M1060X5A 60"W x 5'L **\$520**

JF-KS-M1072X6A 72"W x 6'L **\$785**

JF-KS-M1072X7A 72"W x 7'L **\$875**

Sandpiper Mats

Quick, effective filling of aerated holes. Natural cocoa fibers won't damage tender grasses.

SP-4872 4'x6' complete mat **\$650**

SP-6072 5'x6' complete mat **\$750**

SP-7272 6'x6' complete mat **\$857**

Drag Brush

Gently and evenly works top dressing material into the green. Helps control thatch when used before mowing. Hinged and Weighted to help manage contours and uneven areas.

STD52000 Drag brush only 54" W x 26" H **\$535**

STD52013 Single Replacement Brush **\$180**

Drag Brush Extension

STD52050 Set of 2 Drag Brush Extensions **\$585**

STD52063 Single Extension Replacement Brush **\$90**



Bunker Rake with Woodgrain Handle

Composite bunker rake with a faux wood pattern veil wrap. Offers protection from splinters Fits Chief, Tour Pro and Tour Smooth II Bunker Heads.

STD11220 Composite 60" Handle **\$17.25**

STD11221 Composite 72" Handle **\$21**



Duo-Rake

Now with new stronger, 15" [38 cm] gusset-reinforced high impact plastic head. Bolt and cone [included] is all you need for assembly

STD11530 Curved Handle Gold 64" [box of 6] **\$250.50**

STD11540 Curved Handle Green 64" [box of 6] **\$250.50**

STD11500 Aluminum Handle Natural 54" [box of 12] **\$351**

STD11525 Aluminum Handle Yellow 54" [box of 12] **\$429**

STD11575 Aluminum Handle Green 54" [box of 12] **\$429**

The Chief Bunker Rake

This timeless, toothless rake has two sides: a smooth side to pack down the vertical sides of the bunker and ridged side to rough up the bottom of the bunker without leaving large grooves in the sand.

STD11901 Head Only 20" **\$13.50**

STD11920 Gator Grip Handle 72" [box of 6] **\$195**

STD11900 Aluminum Handle 54" [box of 12] **\$378**

STD11910 Gator Grip Handle 60" [box of 12] **\$345**



Cart/Personal Bunker Rake

48" handle and 15" high impact plastic head fits most golf cart bagwells. Perfect for golfers to carry as a "personal bunker rake." Lightweight, easy to take apart, easily fits in your golf bag. Sold in box of 12

STD11400 Wood Handle Yellow 48" **\$162**

STD11425 Wood Handle Green 48" **\$162**



Tour-Lite Rakes [box of 12]

Impact resistant, 15" polyethylene molded head. Ultralight, plastic coated steel handle. Redesigned neck for added strength and durability.

STD12350 Ultralight Steel Handle Yellow 54" **\$168**

STD12375 Ultralight Steel Handle Green 54" **\$168**

Tour Pro Rakes

A single, self tapping screw [included] is all you need for assembly. 20" and 25" heads ensure tracks are covered with minimum effort, while pioneering design generates tournament quality surfaces

Tour Pro 20"

STD11750 64"L Curved Handle Green [box of 6] **\$250.50**

STD11700 54"L Composite Handle Green [box of 12] **\$333**

STD11760 54"L Aluminum Handle Green [box of 12] **\$417**

STD11720 60"L Gator Grip Handle Green [box of 12] **\$384**

STD11730 60"L Gator Grip Handle Brown [box of 12] **\$384**

Tour Pro 25" [box of 6]

STD11790 60"L Gator Grip Handle Green **\$211.50**

STD11770 72"L Gator Grip Handle Green **\$234**

STD11780 72" L Gator Grip Handle Brown **\$234**

Economy Rake

Wooden or ultralight, plastic-coated steel handles. Tough, high-impact 15" molded head [and handle] are light enough to float. Sold in box of 12

STD11600 Wood Handle Yellow 48" **\$135**

STD11625 Wood Handle Green 48" **\$135**

STD11660 Ultralight Steel Handle Yellow 54" **\$141**

STD11665 Ultralight Steel Handle Green 54" **\$141**



Tour Smooth II

Smooths both fine and coarse sand into perfect playing conditions quickly and easily. A single, self tapping screw [included] is all you need for assembly. Comes in both 15and 22" head sizes.

Tour Smooth II 15"

STD11850 64"L Curved Handle Green [box of 6] **\$222**

STD11800 54"L Composite Handle Green [box of 12] **\$276**

STD11860 54"L Aluminum Handle Green [box of 12] **\$360**

STD11820 60"L Gator Grip Handle Green [box of 12] **\$327**

STD11830 60"L Gator Grip Handle Brown [box of 12] **\$327**

Tour Smooth II 22"

STD12210 60"L Gator Grip Handle Green [box of 6] **\$193.50**

STD12220 72"L Gator Grip Handle Green [box of 6] **\$216**

MAINTENANCE



MAINTENANCE

PRICE MATCH GUARANTEE *with Any Major Competitor*

TOOLS



Levelawn Pro w/ Split Handle

Helps with top dressing by removing stones from the soil, breaks up small clods of sand or loam. Smooths soil for easy planting. New 2 piece wooden handle for easy shipping is 72" long.

STD29310 30" **\$165**
STD29320 36" **\$172**



Magnum Maintenance Rake [Straight Tooth]

Multi-functional. Designed for construction and repair. Robust rake head design: four different sizes. Long teeth tackles grading. Straight edge handles leveling. 66" straight handle.

STD71124 24" head **\$135**
STD71130 30" head **\$140**
STD71136 36" head **\$145**
STD71142 42" head **\$150**

Magnum Landscape Rake [Sifting Tool]

Sifting teeth separate stone and debris: flips over for straight edge leveling. 66" straight handle.

STD71224 24" head **\$130**
STD71230 30" head **\$150**
STD71236 36" head **\$160**
STD71242 42" head **\$165**



Magnum Lute

Top dresses smaller areas. Clears aeration plugs from greens and tees. Reversible blade lets you push or pull material. 66" straight handle.

STD71424 24" head **\$127**
STD71436 36" head **\$140**



Magnum Roller Squeegee

Designed for turf or hard surfaces. Efficient, non-absorbent foam rubber head. Stainless steel axle, heavy duty bolts and lock washers and industrial-grade end caps. 57.5" ergonomically angled handle.

STD71324 24" head **\$275**
STD71336 36" head **\$295**
STD71348 48" head **\$305**



Magnum Spike Roller

Prepares fine turf for overseeding. Breaks up moss and algae. Lightly aerates bentgrass greens and tee boxes. Stainless steel axles. Heavy-duty bolts and lock washers. Industrial-grade end caps. 57.5" ergonomically angled handle.

STD71708 8" head **\$199**
STD71716 16" head **\$295**



Magnum Monster Broom

Perfect for removing dew or worm casts from greens and tees. Makes short work of shop floors and tennis courts. Two rows of replaceable bristles - mounted to a giant 84" head
STD72150 84" head / 40" handle **\$340**



Debris Rake

Gusseted head adds extra strength. Great for removing pine needles and as a replacement for traditional bunker rakes
STD11300 60" handle **\$139**



Magnum General Purpose Broom

For everyday cleanup with a reinforced head/handle design
STD72100 24" head / 57.5" handle **\$132**



Magnum Maximum Duty Broom

28" all aluminum head with twist and gusset bracing. Scrape edge removes caked on material. To soften brush action, simply remove one row of bristles.
STD72125 28" head / 57.5" ergonomically angled handle **\$180**



Spring Brace Rake

Heavy duty spring keeps all 24 teeth close to the ground. Heavy duty tines are braced for consistent raking action.
STD72400 24" head / 54" handle **\$72**

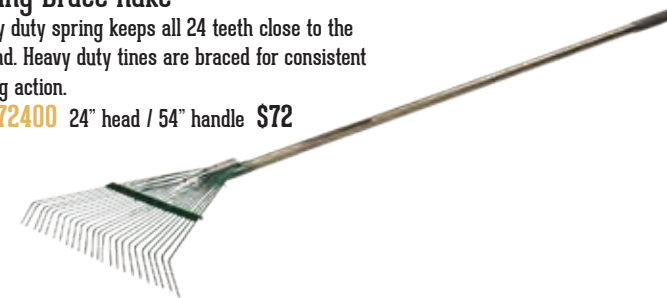

Bunker Debris Sieve Pro

The easy way to sift sand to remove bunker debris and stones. Has a 19" head and a new 72" two piece handle.
STD29335 1/2" openings **\$165**
STD29330 1/4" openings **\$165**



CUSTOMIZE & ADD YOUR OWN MESSAGE & LOGO!

MAINTENANCE



MAINTENANCE

PRICE MATCH GUARANTEE with Any Major Competitor

TOOLS



Du-Whipper

New and improved outer shell for more durability. Added 2 new grips for proper ergonomics. Thumb grip added to end of handle. Telescoping fiberglass pole stretches 6' to 16'

Durable threaded cap. **STD34300 Du-Whipper \$73**



Weed Wand

Lightweight, 36" wand is designed to minimize spills, and for easy refills. 1" diameter applicator tips precisely control chemical flow and eliminate over-spray.

STD29700 1" Diameter / Weed Wand \$49

STD29701 Replacement Tips \$11



Greenskeeper Ball Mark Repair Tool

Great time and labor saving tool for quick, near flawless repairs on greens. 36" handle makes repairs fast and easy. Meticulously lifts dirt and grass into place in one motion.

STD27200 36" handle \$224



Depth Gauge

Ensure consistent, accurate cuts with Magnum™ or Pro II hole cutters

STD28600 fits 4.25" shells \$30

Replacement Shells Available for Cup Cutters



Turf Doctor

Four razor sharp blades secure 9" square cut wedge shaped sod blocks that fit and butt perfectly.

STD29200 9" square \$590



Hexagon Turf Repair Tool

Innovative plug design for easy sod/soil removal and seamless replacement. Six sided plugs pull wedges that are 7"W x 4"D

STD29225 \$259



Heavy-Duty Irrigation Head Trimmer

One handle works with a wide range of head sizes or yardage markers. Plated steel construction. Trimmer head dimensions are outside diameters.

STD29905 5" Head \$87

STD29906 6" Head \$88

STD29907 7" Head \$98

STD29908 8" Head \$107

STD29909 9" Head \$113

STD29910 10" Head \$124

STD29911 11" Head \$125



Soil Profile Sampler

Quickly pull a clean root zone sample. Steel construction. Zinc-plated, case hardened blade.

STD29400 8" H x 4" W x 3/4" D \$340



HAMMERSTRIKE Hole Cutter

- Forceful hammer action for superior cuts with precision strike technology
- Unbeatable value at a lower price
- Bubble level included in handle
- Built to last with Standard Golf quality
- Side mounted shell is stronger: quicker to change
- Foot ejection pedal allows for easy plug removal: ejection handle won't get in the way.
- Foot pedal slot doubles as built in depth gauge

STD29060 Hammerstrike with Straight Shell/ Sharpened Outside \$595

STD29051 Replacement Blade, Sharpened Inside \$95

STD29052 Replacement Blade, Sharpened Outside \$95

Pro II Hole Cutter [4.25" diameter]

Comes with Diamond Laser Cut Hole Shells. Cold rolled tubing. Carbon steel shaft. Adjustable depth collar. Foot ejector.

STD28700 4.25" D Straight Shell [sharpened inside] \$229

STD28800 4.25" D Scalloped Shell [sharpened inside] \$229

STD28801 4.25" D Scalloped Shell [sharpened outside] \$229

STD28775 6" D Straight Shell [sharpened inside] \$245

STD28785 8" D Scalloped Shell [sharpened inside] \$245

Magnum Hole Cutter [4.25" diameter]

Comes with Diamond Laser Cut Hole Shells. Year after year our most popular model. Field tested and proven in all soils with flying colors. Smooth lever action. 4.25" Diameter

STD28960 Straight Shell [sharpened inside] \$360

STD28970 Scalloped Shell [sharpened inside] \$360

STD28980 Scalloped Shell [sharpened outside] \$360

MAGNUM PRO Hole Cutter

- Enhanced strength for superior performance
- Effortless transport with locking ejection handle
- Bubble level included in handle
- Comfort meets control with golf grip ejection handle
- Side mounted shell is stronger and quicker to change

STD28930 Magnum Pro with Scalloped Shell, Sharpened Inside \$425

STD28940 Magnum Pro with Scalloped Shell, Sharpened Outside \$425

STD28920 Magnum Pro with Straight Shell, Sharpened Inside \$425

STD28931 Replacement Straight Shell, Sharpened Inside \$79

STD28932 Replacement Scalloped Shell, Sharpened Inside \$79

STD28933 Replacement Scalloped Shell, Sharpened Outside \$79



SG Pro Hole Cutter [4.25" diameter]

This innovative machine grade tool guarantees a flawless cut every time. Its precision ensures that you achieve the perfect hole, eliminating any room for error. Cut perfectly circular, crisp holes every time Safe for your body, lift and throw the hammer mechanism, saving stress on your back. Ratchet ejection allows you to easily remove and place plugs in full. Included depth gauge allows for uniform cup depth with single cut holes allowing easy plug replacement. Bubble level in handle. 4.25" Diameter

STD29000 SG Pro w/ Straight Shell [sharpened inside] \$1,950

STD29010 SG Pro w/ Straight Shell [sharpened inside] \$1,950

STD29001 Replacement Blade- Straight Shell [sharpened inside] \$175

STD29002 Replacement Blade- Straight Shell [sharpened outside] \$175

STD29003 Depth Gauge \$95

STD29004 Docking Station \$195

MAINTENANCE



IRRIGATION



Power Trim Pro Series

Trim Golf Sprinkler Heads, fairway yardage markers and round valve boxes. Heavy duty steel construction. Easily attaches to any straight, string trimmer [Tool shown not included] Blade available in three sizes.

- JF-UH-PTC-007** Power Trim 7" Cutting Blade \$39.25
- JF-UH-PTC-008** Power Trim 8" Cutting Blade \$50
- JF-UH-PTC-011** Power Trim 11" Cutting Blade \$65.25

7" Cutting Blades

TURBO TRIM JF-UH-TTRC-007	Toro: 730, 760, 860, 830, 834S, DT 34/35, 835, 630	Rain Bird: 700, 751 [New Series]	\$90.75
POWER TRIM JF-UH-PTC-007	Toro: 730, 760, 860, 830, 834S, DT 34/35, 835, 630	Rain Bird: 700, 751 [New Series]	\$39.25
		6" Round Valve Boxes	

8" Cutting Blades

TURBO TRIM JF-UH-TTRC-008	Toro: 670, 750, 780, 854, 855, 880DT 54/55, 650, Infinity Series	Rain Bird: E700, E750, 900, E950 [Newer Series]	\$90.75
POWER TRIM JF-UH-PTC-008	Toro: 670, 750, 780, 854, 855, 880DT 54/55, 650, Infinity Series	Rain Bird: E700, E750, 900, E950 [Newer Series]	\$50
		Hunter: 800, 900 Series	

11" Cutting Blades

TURBO TRIM JF-UH-TTRC-011	Toro: 690	Kirby Fairway Markers, 9" & 10" Round Valve Boxes	\$106
POWER TRIM JF-UH-PTC-011	Toro: 690		\$65.25
		6" Round Valve Boxes	



Macabee Gopher Trap

Eliminate unwanted gophers with the Macabee Gopher Trap. High carbon spring steel ensures a long lasting performance, proven reliability, and easy setup.
JF-MAC-400680 \$14.50



Turbo Trim Pro Ratchet Series

The only trimmer with a forward and reverse drive ratchet mechanism. Super heavy duty steel construction and powder coat finish with comfortable rubber handle grips. Blade available in three sizes.

- JF-UH-TTRT-100** Turbo Trim Tool, without cutting blade \$242
- JF-UH-TTRC-007** Turbo Trim 7" cutting blade \$90.75
- JF-UH-TTRC-008** Turbo Trim 8" cutting blade \$90.75
- JF-UH-TTRC-011** Turbo Trim 11" cutting blade \$106



H2O Maximizer® Pellets

HOLD MORE PLANT AVAILABLE WATER W/ H2O MAXIMIZER PELLETS

- Increase irrigation and rain efficiency by enhancing plant available water
- Improve water infiltration and water holding capacity of soil
- Remains active in the soil for 4-6 weeks, then bio-degrades into natural materials
- Polymer resin delivers increased plant available water

JF-UH-UHH2OPEL - H2O MAXIMIZER PELLETS [8 oz / 227 gm pellet - 16 pellets per case] - \$280



Tournament Ready Pellets

PROVEN TOURNAMENT READY FORMULA IN SOLID PELLET FORM

- Treat small turf areas while hand watering using Underhill PelletPro applicator
- Inert binder is carrier for Tournament Ready Soil Surfactant for metered hand watering Tournament Ready Pellets help cool canopy temperatures of turfgrass during high heat, stress conditions
- Pellet jar can be inserted in pellet applicator reservoir to modulate soil surfactant output

JF-UH-UHTRPEL - TOURNAMENT READY PELLETS [8 oz / 227 gm pellet - 16 pellets per case] - \$336



Tournament Ready Plus

PROVEN TOURNAMENT READY FORMULA W/ ACTOSOL AND MICRONUTRIENTS

- A combination of Tournament Ready proven formula but with the addition of humic and fulvic acid, and micronutrients
- Uniform moisture management [doesn't bind in the thatch layer]
- Increases soil moisture without causing "spongy turf" problems
- The multiple benefits of humic and fulvic acids, calcium, and iron

JF-UH-UHTRPLPEL - TOURNAMENT READY PLUS PELLETS [8 oz / 227 gm pellet - 16 pellets per case] - \$424



Pellet Pro

Our heavy duty surfactant applicator, high flow valve and Precision™ Cloudburst™ nozzle combo comprises the finest wetting agent gun available.

Features:

- 35+ GPM to get the job done faster!
- Ultra Heavy Duty construction: brass fittings, aircraft aluminum, stainless steel, precision engineered glass
- Pellet rotation [1 RPS] evenly dissolves/applies tablets

Ordering

Pellet Pro

JF-UH-A-PPWA50K	PelletPro™ Applicator Gun: Control On/Off, Cloudburst Nozzle, High Flow Plastic Valve 3/4" Inlet, 3/4" MHT x 1" FHT Adapter	\$172
JF-UH-A-PPWA50K-E	PelletPro™ Applicator Gun: Control On/Off, Cloudburst Nozzle, High Flow Plastic Valve & 3/4" MHT x Quick Connect	\$195
JF-UH-PPWA48BRK	PelletPro Applicator Gun, Control On/Off, Cloudburst Nozzle, High Flow Brass Valve: 3/4" inlet + 3/4" MHT x 1" FHT Adapter	\$172
JF-UH-A-PPQ-075	PelletPro™ In-line Applicator: 3/4" FHT inlet, 3/4" MHT outlet	\$105
JF-UH-A-PPQ-100	PelletPro™ In-line Applicator: 1" FHT inlet, 1" MHT outlet	\$114
JF-UH-A-PPWASHNK	PelletPro™ Applicator Gun: Control On/Off, Shower Head Nozzle, High Flow Plastic Valve, 3/4" Inlet, 3/4" MHT x 1" FHT Adapter	\$172
JF-UH-PPWASHNK-E	PelletPro™ Applicator Gun: Control On/Off, Cloudburst Nozzle, High Flow Plastic Valve & 3/4" MHT x Quick Connect	\$195
JF-UH-A-PPB	In-line Filter Bowl [gasket not included]	\$43
JF-UH-A-PPBG	Gasket	\$7



MAINTENANCE

PRICE MATCH GUARANTEE *with Any Major Competitor*

IRRIGATION



Magnum™ Full Throttle Ultra-MAX Premium Plus Series

Single Variable Flow: Delivers steady, maximum volume fog, jet stream and fan patterns. High Flow Model: 15-40 GPM [57-151 L/min] Super High Flow Model: 39-100 GPM [148-379 L/min]



Magnum™ Full Throttle Ultra-MAX Premium Pro Series

Single Variable Flow: Delivers steady, maximum volume fog, jet stream and fan patterns. High Flow Model [only]: 15-40 GPM [57-151 L/min]



Magnum™ Turbo Shift Premium Pro Series

Dual Variable Flow: Delivers light fog and low volume jet stream patterns before shifting to high volume jet stream and fan patterns. High Flow Model [only]: Opens with 12-17 GPM [45-64 L/min] Turbo Shifts to 20-43 GPM [76-163 L/min]



Magnum™ UltraMAX Multi-BLAST™

UltraMax MultiBLAST variable flow nozzle with 1" NPSH inlet. Dual Variable Flow: Delivers light fog and low volume jet stream patterns before shifting to high volume jet stream and fan patterns. Low Volume Model with 3/4" FHT Inlet: Opens with 7-12 GPM [27-45 L/min]. Turbo Shifts to 14-17 GPM [53-64 L/min]

JF-UH-NG850 \$369



Magnum™ Turbo Shift UltraMAX Premium Plus Series

Dual Variable Flow: Delivers light fog and low volume jet stream patterns before shifting to high volume jet stream and fan patterns. All flow rates based on 80 psi [5.5 bar]. Nozzles and Valves rated at 600 psi working pressure.



Pattern Master™

Multi Pattern Spray Nozzle
 · Trigger flow control.
 · 8 Easy-Click Selectable Patterns
 · Metal-Zinc / Brass Construction
 · Fits 3/4" Hose Thread Inlet



Pro Spray™

Variable Spray Gun
 · Trigger flow control
 · Smooth Trigger Operation
 · Metal-Zinc / Brass Construction
 · Fits 3/4" Hose Thread Inlet



Pattern Master™

Multi Pattern Spray Nozzle
 · EASY THUMB CONTROL
 · 7 Easy-Click Selectable Patterns
 · Metal-Zinc / Brass Construction
 · Fits 3/4" Hose Thread Inlet



Pro Spray™

Variable Spray Gun
 · EASY THUMB CONTROL
 · Smooth Operation
 · Metal-Zinc / Brass Construction
 · Fits 3/4" Hose Thread Inlet

Ordering

JF-UH-NG250-BS	PatternMaster™ Gold Series Multi-Pattern -Thumb Control	\$25
JF-UH-NG250-P	ProSpray™ Gold Series Variable Spray -Thumb Control	\$25
JF-UH-NG200-BS	PatternMaster™ Gold Series Multi-Pattern Spray	\$27.50
JF-UH-NG200-P	ProSpray™ Gold Series Variable Spray	\$27.50
JF-UH-NG350	Magnum-Mini™ Gold Series Adjustable Spray	\$20.50
JF-UH-NG200-TW	Extender™ Gold Series Wand Spray	\$34.25



Magnum™ Stinger

The Magnum™ Stinger All Pressure nozzle is an incredibly smooth operating nozzle, making it ideal for low pressure or low flow rate situations.

JF-UH-NG400 \$30



Magnum™

The Magnum solid metal hose nozzle is a precision-machined with very smooth operation and outstanding distribution patterns make it ideal for high-demand areas like greens and tees.

JF-UH-NG450 \$41.25



RainPro™ Gentle Spray

Beautiful, soft spray pattern perfect for flowers or plants. Comes apart for easy cleaning and comes with three Stainless Steel mesh plates with 450, 750 or 1000 hole patterns.

JF-UH-RP-75PL

RainPro™ Gentle Spray Nozzle 3/4" \$19

JF-UH-RPW-75PL

RainPro™ Gentle Spray Wand 306quot; - 3/4" \$38



RainPro™ Ultra Max

Beautiful, soft spray pattern perfect for flowers or plants. Comes apart for easy cleaning and comes with three Stainless Steel mesh plates with 450, 750 or 1000 hole patterns.

JF-UH-SHN-75 \$49

MAINTENANCE



MAINTENANCE

PRICE MATCH GUARANTEE *with Any Major Competitor*

IRRIGATION



PowerGULP™

PowerGulp Battery Operated Hand Pump. Pumping just got so much easier with the flip of a switch and the ability to pump 11 GPM even in the dirtiest of water.

Pump Specifications:

- Flow Rate - 11 GPM
- Length - 48"
- Weight - 4 lbs [without battery]
- Battery Run Time - Up to 60 Minutes w/ 4 Amp Hr. Battery
- Head Height - 15 ft

JF-UH-PG-18V \$225



PowerGulp 18V x 4.0A Battery

Underhill battery and adapter attachments for other brand batteries.

- JF-UH-A-PG-BAT** Underhill Battery **\$65**
- JF-UH-A-PG-APMI** Adapter Plate for Milwaukee **\$20**
- JF-UH-A-PG-APDE** Adapter Plate for DeWALT **\$20**
- JF-UH-A-PG-APMA** Adapter Plate for Makita **\$20**



PowerFLOW™ Series

WORKS GREAT WITH ALL OUR NOZZLES Full Flow Rates Allow Up to 48 Gpm [on 1-Inch Model], Higher Than Any Other Control Valve. Easily Control Water Flow with Nothing More Than Your Thumb

- JF-UH-CV10H** Brass PowerFLOW Control Valve 1½" NPSH **\$76**
- JF-UH-CV075H** Brass High-Flow ¾" Control Valve **\$33.25**

Marking Flags

4" x 5" Marking flags on 21" wire [50 pack] are available in 6 colors

- JF-UH-A-FLAG - Yellow**
- JF-UH-A-FLAG-B - Blue**
- JF-UH-A-FLAG-O - Orange**
- JF-UH-A-FLAG-P - Pink**
- JF-UH-A-FLAG-R - Red**
- JF-UH-A-FLAG-W - White**

\$18.75 per pack



CoolPro™

CoolPro Nozzle/Valve, ¾" Hose Thread inlet ¾" Hose Thread Fog Nozzle, 4 GPM @80 PSI Ergonomic handle valve provides easy grip and variable on/off control. Solid metal design uses zinc and aircraft aluminum for durability.

JF-UH-HNC075 \$76.25



Thumb Control Valve

Same full function as our brass valve, but built with heavy duty composite construction. Stainless steel internal valve prevents leaking and promotes longevity. Easy to use thumb control handle.

JF-UH-CV075P Plastic High-Flow ¾" Control Valve **\$15**



MultiMax™

SOLID BRASS ADJUSTABLE NOZZLE High Pressure Easy Twist variable pattern nozzle, no leak design fine mist to power jet spray adjustment 5 GPM at 80 psi.

JF-UH-HS-075 MultiMax Adjustable Nozzle -¾" GHT Inlet **\$17.75**



UltraBrass™ Gold Series Coupler Keys

ULTRA BRASS KEYS ARE HEAVY DUTY SOLID BRASS WITH STAINLESS STEEL

Single Lug designed to fit Underhill Ultra Brass Quick Coupler QVS Series 1-Piece Valves, And QVD Series 2-Piece Valves, Also Compatible with Other Popular Valve Brands. Interchanges with Rain Bird, Toro, Hunter & Buckner.

		Buckner	Rain Bird	Toro	Hunter	
JF-UH-QK-075	¾" MPT x ½" FPT Key	Q33K07	33DK	463-01	N/A	\$41.50
JF-UH-QK-100	1" MPT x ¾" FPT Key	QB44K10	44K	464-01	HK-44	\$87
JF-UH-QK-125	1" MPT x ¾" FPT Key	QB5RK10	55K	465-01	N/A	\$134.75
JF-UH-QK-150	1½" MPT x 1¼" FPT Key	N/A	N/A	N/A	N/A	\$156.75
JF-UH-QK-150RBTB	1½" MPT x 1¼" FPT Key	QC151	7K	466-01	N/A	\$156.75
JF-UH-QK-100AT	1" MPT x ¾" FPT ACME threaded Key	QB44KAT10	44KA	464-03	HK-44A	\$130.25



UltraBrass™ Gold Series Coupler Valves

DURABLE SOLID BRASS, SINGLE SLOT/LUG ESSENTIALS BUILT TO LAST. Underhill Valves are Constructed of Solid Red Brass and Stainless Steel, with High Visibility Vinyl Covers, Our Valves Incorporate Rugged 1 and 2 Piece Design Options.



Hose Swivels

Designed to prevent kinks and tangles in hoses ensuring a smooth flow of water.

JF-UH-HS-75	¾" FPT x ¾" MHT outlet	\$59.50
JF-UH-HS-100	1" FPT x ¾" MHT outlet	\$68.25
JF-UH-HS-101	1" FPT x 1" MHT outlet	\$69.75
JF-UH-HS-151	1½" FPT x 1" MHT outlet	\$111.50

Single Piece Body Brass Quick Couplers

		Buckner	Rain Bird	Toro	Hunter	
JF-UH-QV-075R	¾" Quick Coupler w/ Yellow Rubber Cover	QCV075R	3RC	473-01	N/A	\$76.25
JF-UH-QV-100R	1" Quick Coupler w/ Yellow Rubber Cover	QCV100R	33DRC	473-21	N/A	\$95.75
JF-UH-QV-150R	1½" Quick Coupler w/ Yellow Rubber Cover	QCV151R	N/A	476-01	N/A	\$193.25

Two-Piece Body Brass Quick Couplers

		Buckner	Rain Bird	Toro	Hunter	
JF-UH-QV-075-2P	¾" Quick Coupler w/ Yellow Rubber Cover	QB33RC07	N/A	N/A	N/A	\$90.75
JF-UH-QV-100-2P	1" Quick Coupler w/ Yellow Rubber Cover	QB44RC10	44-RC	100-2SLVC	HQ-44	\$121



IRRIGATION



HoseTap™

HoseTap™ gives you a hose connection anywhere you have a TORO® or RAIN BIRD® electric, valve in head sprinkler, a fast connection when quick couplers or hose bibs are not available. Includes aircraft aluminum body [won't break or wear out like plastic] anodized with sprinkler manufacturer color, O-ring, riser, 1" Brass swivel and 3/4" adapter.



HoseTap™ with 1" swivel & adapter

JF-UH-HN-T100S	HoseTap™ for TORO® 1" inlet golf sprinklers	\$129.75
JF-UH-HN-T150S	HoseTap™ for TORO® 1½" inlet golf sprinklers	\$129.75
JF-UH-HN-R125S	HoseTap™ for RAIN BIRD® Eagle 700 Series sprinklers	\$129.75
JF-UH-HN-R150S	HoseTap™ for RAIN BIRD® Eagle 900 Series sprinklers	\$129.75

Includes 1" brass swivel and 3/4" adapter.

HoseTap™ with 3/4" swivel & adapter

JF-UH-HN-T100-75	HoseTap™ for TORO® 1" inlet golf sprinklers	\$120.25
JF-UH-HN-T150-75	HoseTap™ for TORO® 1½" inlet golf sprinklers	\$120.25
JF-UH-HN-R125-75	HoseTap™ for RAIN BIRD® Eagle 700 Series sprinklers	\$120.25
JF-UH-HN-R150-75	HoseTap™ for RAIN BIRD® Eagle 900 Series sprinklers	\$120.25

Includes 3/4" brass swivel.

HoseTap™

JF-UH-HN-T100	HoseTap™ for TORO® 1" inlet golf sprinklers	\$68.25
JF-UH-HN-T150	HoseTap™ for TORO® 1½" inlet golf sprinklers	\$68.25
JF-UH-HN-R125	HoseTap™ for RAIN BIRD® Eagle 700 Series sprinklers	\$68.25
JF-UH-HN-R150	HoseTap™ for RAIN BIRD® Eagle 900 Series sprinklers	\$68.25

Does not include 1" brass swivel or adapter.



UltraBrass™ Gold Series Impact Sprinklers

You Can't Beat Our Proven Impact Drive Sprinklers. Designed with High Uniformity Nozzles, Available in Full Circle and Full/Part Circle Models Along with Additional Nozzle [Gpm/Radius] Options.

Ordering	Full Circle Sprinklers	GPM	Radius [ft.]	
JF-UH-SI075F	3/4" MPT Full Circle	11	50	\$55
JF-UH-SI100F	1" MPT Full Circle	25.4	66	\$125.75
JF-UH-SI125F	1¼" MPT Full Circle	48.3	93	\$350

Full Circle and Par/Full Circle Sprinklers

Solid Brass Construction. Stainless Steel Drive Spring, Bearing Assemble Hood for longer wear life. Chemical Resistance Bearing Seals. Straight-Flow, Low Pressure Loss. Standard Solid Brass Nozzle included.

Ordering	Part/Full Circle	GPM	Radius [ft.]	
JF-UH-SI075P	3/4" MPT Part/Full Circle	8.3	63	\$111.50
JF-UH-SI100P	1" MPT Part/Full Circle	28	71	\$207
JF-UH-SI125P	1¼" MPT Part/ Full Circle	66	94	\$502



Twist-Ease

High Quality, High Flow, Brass Swivel that fits between your Hose and Nozzle. Simply pull the Hose by the Nozzle and All Twists, Kinks and Tangles will Spin Out with the Swivel making untangling your Hose a Breeze!

- JF-UH-HSF-75 3/4" kink eliminator \$25
- JF-UH-HSF-100 1" kink eliminator \$32



Superkey

Multi purpose tool for TORO, RAINBIRD golf sprinklers. Great for John Deere/Signature sprinklers too! All in one tool for your golf sprinklers.

JF-UH-A-SKTRB \$41



Roller Pro

The 22" wide stainless steel roller of RollerPro™ provides a stable field position for supplemental watering. Designed for years of hard use, it is ideal for watering dry spots and newly seeded areas. 22" wide stainless steel roller is weighted to prevent movement during use. 1" inlet and outlet adapters included. Standard 1" FHT inlet x 1" female NPT outlet

JF-UH-A-RP221 \$195



DrainBlaster™

High Pressure Drain Cleaning Nozzle

- Front jet cuts through blockage
- Rear jets propel nozzle upline
- Two stage flushing action
- Minimum water pressure: 70 psi
- Heat treated grade 303 Stainless Steel for long life
- Great for sleeving under sidewalks or cart paths

JF-UH-DN-75 DrainBlaster Drain Cleaner Nozzle- 3/4" FHT Inlet \$119.25

JF-UH-DN-10 DrainBlaster Drain Cleaner Nozzle- 1" FHT Inlet \$146

SUPER HIGH-CAPACITY WATER REMOVAL SUCTION PUMPS

Whether you need to remove water from sprinklers and valve boxes or other areas or devices, UltraMax Series Pumps are the ideal tools for the job

BIG GULP PRO Pump

- 35 oz./stroke
- 36" pump chamber / 72" outlet hose

Underhill GULP Pro Pump

- 19 oz./stroke
- 14" clear pump chamber / 36" outlet hose

JF-UH-A-G3672-CK	BIG GULP PRO Pump w/ 72" Outlet Hose	\$64
JF-UH-A-G1236-C	GULP PRO Pump w/ 36" Outlet Hose	\$50
JF-UH-A-G12S-C	GULP PRO Syringe	\$47
JF-UH-A-GRPVB	GULP PRO Bottom Valve	\$10.50
JF-UH-A-GMG2	GULP PRO MudGuard	\$17.75
JF-UH-A-GRPD	GULP PRO Diaphragm & Plunger [2]	\$10.50
JF-UH-A-GRPTE	GULP PRO Top Elbow	\$10.50
JF-UH-A-GRPSD	GULP PRO Syringe Diaphragm & Plunger [2]	\$10.50
JF-UH-A-PG-CT-10	10 foot Discharge Tubin	\$21.50



MAINTENANCE



MAINTENANCE

PRICE MATCH GUARANTEE with Any Major Competitor

HOSES



UltraMax™ Red

Ultimate choice for heavy use

- Made of EPDM synthetic rubber
- Kink, tangle & weather resistant
- Available in 3/4" GHT & 1" NPSH
- 800 psi Burst / 200 psi Operating
- 3/4" - 38 lbs, 1" = 59 lbs [per 100 ft]
- Best Longevity and Ability to Drag

Ordering UltraMax™ Red

JF-UH-H75-025R	3/4" UltraMax Hose RED: 25' Length	\$115.50
JF-UH-H75-050R	3/4" UltraMax Hose RED: 50' Length	\$187
JF-UH-H75-075R	3/4" UltraMax Hose RED: 75' Length	\$264
JF-UH-H75-100R	3/4" UltraMax Hose RED: 100' Length	\$330
JF-UH-H75-125R	3/4" UltraMax Hose RED: 125' Length	\$412.50
JF-UH-H75-CR	3/4" UltraMax Hose RED: Custom Length: [fittings not included with custom hose]	\$3.50 per ft.
JF-UH-H75R	3/4" Male GHT Fitting, 3/4" Female GHT Fitting, 2 Ferrules for use on RED custom hose	\$26.50
JF-UH-H10-025R	1" UltraMax Hose RED: 25' Length	\$144.50
JF-UH-H10-050R	1" UltraMax Hose RED: 50' Length	\$258.50
JF-UH-H10-075R	1" UltraMax Hose RED: 75' Length	\$367.25
JF-UH-H10-100R	1" UltraMax Hose RED: 100' Length	\$462
JF-UH-H10-125R	1" UltraMax Hose RED: 125' Length	\$561
JF-UH-H100-CR	1" UltraMax Hose RED: Custom Length: [fittings not included with custom hose]	\$4.75 per ft.
JF-UH-H100CGRB	1" Male NPSH Fitting, 1" Female NPSH Fitting, 2 Ferrules for use on custom hose	\$39.50



UltraMax™ Blue

Best combination of weight, durability, flexibility, pressure strength & flow rate

- Soft & flexible - won't scuff greens
- Available in 3/4" GHT & 1" NPSH
- 1200 psi Burst / 300 psi Operating
- 3/4" - 27 lbs, 1" = 43 lbs [per 100 ft]
- Best Professional PVC Hose

Ordering UltraMax™ Blue

JF-UH-H75-025B	3/4" UltraMax Hose BLUE: 25' Length	\$115.50
JF-UH-H75-050B	3/4" UltraMax Hose BLUE: 50' Length	\$187
JF-UH-H75-075B	3/4" UltraMax Hose BLUE: 75' Length	\$264
JF-UH-H75-100B	3/4" UltraMax Hose BLUE: 100' Length	\$330
JF-UH-H75-125B	3/4" UltraMax Hose BLUE: 125' Length	\$412.50
JF-UH-H75-CB	3/4" UltraMax Hose BLUE: Custom Length: [fittings not included with custom hose]	\$3.50 per ft.
JF-UH-H75GB	3/4" Male GHT Fitting, 3/4" Female GHT Fitting, 2 Ferrules for use on GREEN / BLUE custom hose	\$26.50
JF-UH-H10-025B	1" UltraMax Hose BLUE: 25' Length	\$144.50
JF-UH-H10-050B	1" UltraMax Hose BLUE: 50' Length	\$258.50
JF-UH-H10-075B	1" UltraMax Hose BLUE: 75' Length	\$367.25
JF-UH-H10-100B	1" UltraMax Hose BLUE: 100' Length	\$462
JF-UH-H10-125B	1" UltraMax Hose BLUE: 125' Length	\$561
JF-UH-H100-CB	1" UltraMax Hose BLUE: Custom Length: [fittings not included with custom hose]	\$4.75 per ft.
JF-UH-H100CGRB	1" Male NPSH Fitting, 1" Female NPSH Fitting, 2 Ferrules for use on custom hose	\$39.50

Ordering ShortyPro™ Blue Hoses

JF-UH-H75-S10	3/4" ShortyPro Blue Hose: 10' Length	\$55
JF-UH-H75-S20	3/4" ShortyPro Blue Hose: 20' Length	\$93.50
JF-UH-H10-S10	1" ShortyPro Blue Hose: 10' Length	\$71.50
JF-UH-H10-S20	1" ShortyPro Blue Hose: 20' Length	\$121



UltraMax™ Clear

Lightweight & economical

- Thick, durable outer wall
- light to medium commercial duty
- Available in 3/4" GHT & 1" NPSH
- 600 psi Burst / 150 psi Operating
- 3/4" - 20 lbs, 1" = 32 lbs [per 100 ft]

Ordering UltraMax™ Clear

JF-UH-H75-025C	3/4" UltraMax Hose CLEAR: 25' Length	\$104.25
JF-UH-H75-050C	3/4" UltraMax Hose CLEAR: 50' Length	\$165
JF-UH-H75-075C	3/4" UltraMax Hose CLEAR: 75' Length	\$220.25
JF-UH-H75-100C	3/4" UltraMax Hose CLEAR: 100' Length	\$280.50
JF-UH-H75-125C	3/4" UltraMax Hose CLEAR: 125' Length	\$352
JF-UH-H75-CC	3/4" UltraMax Hose CLEAR: Custom Length: [fittings not included with custom hose]	\$3 per ft.
JF-UH-H75R	3/4" Male GHT Fitting, 3/4" Female GHT Fitting, 2 Ferrules for use on CLEAR custom hose	\$26.50
JF-UH-H10-025C	1" UltraMax Hose CLEAR: 25' Length	\$133.50
JF-UH-H10-050C	1" UltraMax Hose CLEAR: 50' Length	\$225.50
JF-UH-H10-075C	1" UltraMax Hose CLEAR: 75' Length	\$313.50
JF-UH-H10-100C	1" UltraMax Hose CLEAR: 100' Length	\$379.50
JF-UH-H10-125C	1" UltraMax Hose CLEAR: 125' Length	\$467.50
JF-UH-H100-CC	1" UltraMax Hose CLEAR: Custom Length: [fittings not included with custom hose]	\$3.75 per ft.
JF-UH-H100CGRB	1" Male NPSH Fitting, 1" Female NPSH Fitting, 2 Ferrules for use on custom hose	\$39.50



Ordering UltraMax™ Green

JF-UH-H75-025G	3/4" UltraMax Hose GREEN: 25' Length	\$107.75
JF-UH-H75-050G	3/4" UltraMax Hose GREEN: 50' Length	\$170.50
JF-UH-H75-075G	3/4" UltraMax Hose GREEN: 75' Length	\$244.25
JF-UH-H75-100G	3/4" UltraMax Hose GREEN: 100' Length	\$313.50
JF-UH-H75-125G	3/4" UltraMax Hose GREEN: 125' Length	\$385
JF-UH-H75-CG	3/4" UltraMax Hose GREEN: Custom Length: [fittings not included with custom hose]	\$3.25 per ft.
JF-UH-H75GB	3/4" Male GHT Fitting, 3/4" Female GHT Fitting, 2 Ferrules for use on GREEN custom hose	\$26.50
JF-UH-H10-025G	1" UltraMax Hose GREEN: 25' Length	\$139
JF-UH-H10-050G	1" UltraMax Hose GREEN: 50' Length	\$236.50
JF-UH-H10-075G	1" UltraMax Hose GREEN: 75' Length	\$342.50
JF-UH-H10-100G	1" UltraMax Hose GREEN: 100' Length	\$418
JF-UH-H10-125G	1" UltraMax Hose GREEN: 125' Length	\$515.75
JF-UH-H100-CG	1" UltraMax Hose GREEN: Custom Length: [fittings not included with custom hose]	\$4.50 per ft.
JF-UH-H100CGRB	1" Male NPSH Fitting, 1" Female NPSH Fitting, 2 Ferrules for use on custom hose	\$39.50



UltraMax™ Green

Lightweight & economical

- 600 psi Burst / 150 psi Operating
- 3/4" - 20 lbs, 1" = 32 lbs [per 100 ft]
- 800 psi Burst / 200 psi Operating
- 3/4" - 28 lbs, 1" = 38 lbs [per 100 ft]
- Lighter Weight & Smooth Exterior

Ordering UltraMax™ Featherweight Hose

JF-H75-050FW	3/4" Featherweight Hose: 50' Length	\$241
JF-H75-075FW	3/4" Featherweight Hose: 75' Length	\$316.75
JF-H75-100FW	3/4" Featherweight Hose: 100' Length	\$395
JF-H75-125FW	3/4" Featherweight Hose: 125' Length	\$494
JF-H10-050FW	1" Featherweight Hose: 50' Length	\$322.25
JF-H10-075FW	1" Featherweight Hose: 75' Length	\$414.75
JF-H10-100FW	1" Featherweight Hose: 100' Length	\$507
JF-H10-125FW	1" Featherweight Hose: 125' Length	\$611
JF-H10-150FW	1" Featherweight Hose: 150' Length	\$738
JF-H75-S20FW	3/4" Featherweight ShortyPro: 20' Length	\$153
JF-H10-S20FW	1" Featherweight ShortyPro: 20' Length	\$175



UltraMax™ Featherweight

Lightest Professional Hose

- 800 psi Burst / 200 psi Operating
- 3/4" - 28 lbs, 1" = 38 lbs [per 100 ft]
- Lighter Weight & Smooth Exterior
- 1200 psi Burst / 300 psi Operating
- 3/4" - 9 lbs, 1" = 15 lbs [per 100 ft]

Ordering ProLine™ Featherweight

JF-UH-H75-050PRO-FW	3/4" GHT Featherweight Hose: 50' Length	\$175
JF-UH-H75-075PRO-FW	3/4" GHT Featherweight Hose: 75' Length	\$241
JF-UH-H75-100PRO-FW	3/4" GHT Featherweight Hose: 100' Length	\$296



ProLine™ Featherweight

Extremely Lightweight

- Tough outer polyester fabric stands up to wear and tear
- Outer springs prevent bending/kinking at connections
- Available in 3/4" GHT
- 800 psi Burst / 200 psi Operating
- 3/4" - 9 lbs [per 100 ft]
- Lightest Commercial Hose



RUSTOLEUM PAINT



Rust-Oleum Marking Paint

Solvent Based Precision Line Marking Paint

Rust-Oleum Industrial Choice® M1600 Precision Line Inverted Marking Paint is a solvent based spray paint that creates crisp, accurate, easy to read and long lasting markings in bright, durable colors.

- Marking paint covers more linear feet per can than other brands
- Precision tip results in virtually no over spray
- Use on grass, gravel, dirt, concrete, asphalt and more
- Resists early fading and chalking
- Adheres to hot surfaces: can be sprayed in the cold [to 25°F]

\$90 per case of 12 cans

Ordering Rust-Oleum Marking Paint

R-203029V	Safety Red
R-203030V	White
R-203027V	Fluorescent orange
R-203022V	Caution Blue
R-203024V	Caution Yellow
R-203025V	High Visibility Yellow
R-203026V	Alert Orange
R-201516V	Orange
R-1675838V	Black
R-1601838V	Clear
R-1634838V	Safety Green
R-203023V	Fluorescent Green
R-1661838V	Fluorescent Pink
R-1669838V	Fluorescent Purple
R-1662838V	Fluorescent Red
R-203028V	Fluorescent Red Orange



Rust-Oleum High Performance Striping Machine

Make crisp, accurate stripes with the Rust-Oleum Industrial Choice® Striping Machine. Its heavy duty wheels work on a variety of terrains and make applying striping paint fast and painless. Just collapse the handle to take it anywhere.

- Adjustable for 2-4" wide lines
- Sturdy steel construction
- Includes convenient storage compartment & holds up to 12 extra cans
- Ideal for use on parking lots, roads, paths and more

R-2395000 \$320



Rust-Oleum High Performance Striping Wand

Make marking projects fast and accurate with the Rust-Oleum Industrial Choice® Marking Wand. This single wheeled, rolling tool applies marking paint with comfort and precision.

- Improves application accuracy, lessens back strain
- Light touch spray gives easy control & reduces finger fatigue
- Comfortable grip
- Lightweight yet durable construction of steel and plastic

R-2388000 \$99.95



Rust-Oleum High Performance Marking Pistol

Make your marking jobs easier with the Rust-Oleum Industrial Choice® Marking Pistol. This hand held tool requires only a light touch to activate the aerosol spray nozzle, preventing finger fatigue and improving accuracy.

- Light touch spray control
- Comfortable grip
- Easy to insert cans
- Allows for continuous spray

R-210188 \$49.95



Accuproducts



Groomer-Gage®

GROOMER-GAGE is a precision measuring instrument for accurately setting the desired grooming depth of groomer or verticutting units.

Product #	Bar Length	Analog	Digital	Metric
JF-AG-007	18"	\$159	\$219	\$188

Add-On	Price
Add a Gage-Guard	\$24.50
Add a Gage-Grip	\$32
Add a Grip-Guard	\$39
Add Aluminum Carrying Case	\$37

Bedknife-Buddy™

A quick and easy way to lightly "touch up" greensmower bedknives.

Product #	Size	Price
JF-AG-BB-01G	The standard Bedknife Buddy is fixed at 7 degrees.	\$29
JF-AG-BB-01	The Adjustable Bedknife Buddy Adjusts from 0-15 degrees	\$39

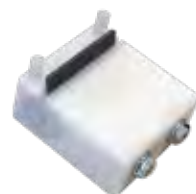

Tru-Depth Sand Probe

The Tru-Depth Sand Probe provides a quick way to check the depth of bunkers. Easily readable ruler measures depth 0"-7".

JF-AG-Tru-07	\$109
--------------	-------



Sleigh Tines

The Sleigh Tine helps avoid catching and pulling up barrier fabrics, stones and any subsurface material. Includes 20 Sleigh Tines.

JF-AG-SLT-20	\$25
--------------	------



PVC Wrenches

This PVC spanner wrench is a high strength zinc plated steel design that provides the proper two-point "push/pull" leverage needed for tightening PVC compression couplings—preventing damage and distortion often caused by the use of pipe and chain wrenches. Each nub wrench will fit two sizes of PVC.

Product #	Size	Price
JF-AG-1215	1215 PVC Nub Wrench	\$29
JF-AG-2025	2025 PVC Nub Wrench	\$34
JF-AG-3040	3040 PVC Nub Wrench	\$39
JF-AG-6000	6000 PVC Nub Wrench	\$44
JF-AG-21236	Complete Set [2 of Each Wrench]	\$239

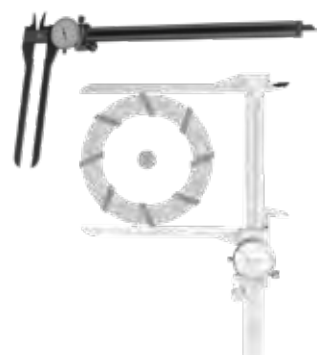

Reel Calipers [12"]

12" dial calipers have extension jaws that enable you to measure the large diameters of reels. Easily determine if your reels are "cone" shaped. Measures inside, outside and depth. Measures in .001 inch.

JF-AG-101RC	\$259
-------------	-------



Turf Topdressing Leveler

Our heavy duty topdressing leveler is great for small jobs such as divot repair on tees or leveling repaired turf on greens, tees, or fairways. The leveler can be flipped over for working in sand or topdressing. Anodized aluminum 60" handle with grip.

JF-AG-TTL-1	\$149
-------------	-------



Accu-Gage®

The ACCU-GAGE® is a precision measuring instrument for making highly accurate height of cut adjustments on greens, tees, or fairways. Fits all makes of greens mowers & works on both grooved and solid rollers.



Product #	Bar Length	Analog	Digital	Metric
JF-AG-001-13	13"	\$139	\$199	\$168
JF-AG-001-15	15"	\$139	\$199	\$168
JF-AG-001-18	18"	\$139	\$199	\$168
JF-AG-001-24	24"	\$139	\$219	\$188

Accu-Gage® II

The Accu-Gage® II is for ease in checking or setting mowers in the field while units are still attached to mowers. Available in Digital Only w/ Aluminum Case

JF-AG-001-11	\$349
--------------	-------



Gauge-Guard



Gauge-Grip



Grip-Guard

Add a Gauge-Guard	\$24.50
Add a Gauge-Grip	\$32
Add a Grip-Guard	\$39
Add an Aluminum Carrying Case	\$37

Verticut-Gage™

The VERTICUT-GAGE is a precision measuring instrument for accurately setting the desired depth on verticutter units. Both above grade and below grade measurements are possible.

JF-AG-015-VC	\$249
--------------	-------

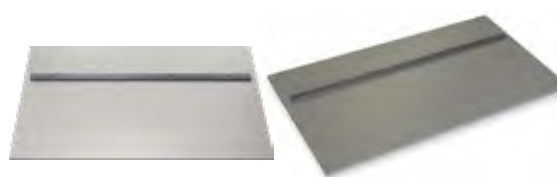

Bench-Plate®

- JF-AG-006-B is ideal for all riding and walking putting green mowers. Mowers up to 26" wide can be adjusted on the 006-B. This model has an attached parallel bar measuring 5/16" thick. Flatness tolerance .003 inch.
- JF-AG-006-A is ideal for mowers of all sizes including large fairway mowers. This model has an attached parallel measuring 3/8" thick. Flatness tolerance .004".

Product #	Size	Price
JF-AG-006-B	18" - 24"	\$469
JF-AG-006-A	24" - 36"	\$599
JF-AG-006-A	20" - 36" Extra parallel	\$49

Tubular Soil Sampler- Small

The small stainless steel sampler removes a 7" x 1/2" plug.

JF-AG-013T	\$22
------------	------

Tubular Soil Sampler- Large

The large stainless steel sampler removes a 15" x 3/4" plug.

JF-AG-012T	\$34
------------	------

Sample Pro™

The SAMPLE PRO™ makes it easy to inspect the soil. Removes a cross section of soil 6" deep, 2 1/2" wide and 1/2" thick for your inspection.

JF-AG-011T	\$189
------------	-------

Prism-Gage™

The PRISM-GAGE allows the viewer to measure the actual height of the turf grass and thus be able to compare it with mower bench settings. Lines are inscribed at .100, .200, .300, .400, .500, .750, 1.0, and 1.5 inch.

JF-AG-PG-01	\$259
-------------	-------

Green Speed Meter

The Green Speed Meter allows the user to place a numerical value on the speed of the putting surfaces by using the standardized ball roll measurement method.

JF-AG-GS101	\$79
-------------	------

Sand-Comb™

Easily remove stones and debris from your sand bunkers. For Pea Stones, use the 1/4". For Regular use, choose the 1/2".

Product #	Size	Price
JF-AG-SC-16-14	16" Wide Comb, 1/4" Screen Size	\$119
JF-AG-SC-16-12	16" Wide Comb, 1/2" Screen Size	\$119
JF-AG-SC-22-14	22" Wide Comb, 1/4" Screen Size	\$129
JF-AG-SC-22-12	22" Wide Comb, 1/2" Screen Size	\$129





PRICE MATCH GUARANTEE with Any Major Competitor

Golfco Rollers



New 2" Diameter Grooved Competition Rollers

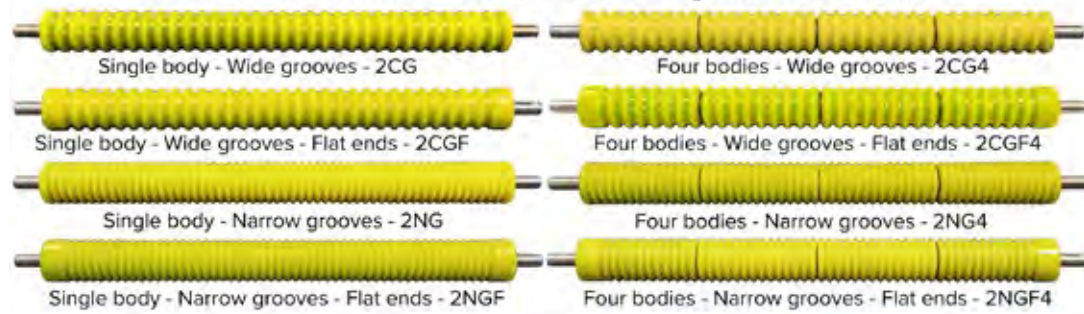

Six bodies - Non-skidding for tight turns & ground undulations



Competition Rollers

Our Competition Rollers are used by some of the world's most renowned and exceptional top golf courses and sports fields.

All of our rollers are Made in the U.S.A.

- Advanced design for bearings, seals and retainer components.
- Competition Rollers are heavy duty, thick wall precision steel rollers.
- All polyurethane covered rollers are made with 1.75" OD, thick wall, precision DOM steel tubing.
- Polyurethane body material limits debris buildup and diminishes transmigration of harmful elements such as disease or fungus.
- Will not shred or fray like plastic materials.
- Will far out last any metallic material in abrasive conditions.
- Minimizes shake and shudder from the motor which reduces wear on the joints and components.
- Polyurethane minimizes turf stress from thermal transfer.
- Minimizes potential for frost buildup.
- Grooved design features no parallel sides within the groove channels.
- Grooved design has large soft radius groove rests and no corners for gentle turf contact.



Cutaway sample of polyurethane Competition Roller. All Competition Polyurethane Rollers have heavy duty precision steel tubing inside. All Competition Rollers hold extremely tight tolerances and are heavy duty steel rollers with polyurethane cast over the steel housing for extra toughness.

Golfco rollers fit numerous mowers and have many styles and sizes. See our website or contact us for all part numbers and options.

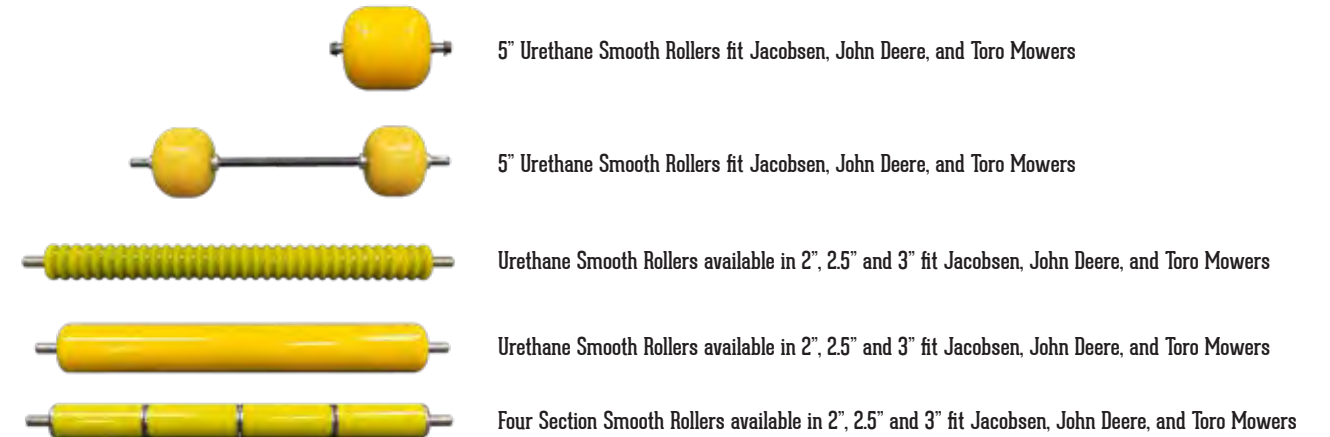

Standard Rebuild Kits Available
Please contact us or see our website for more information
Prices Subject to Change.



PRICE MATCH GUARANTEE with Any Major Competitor

Golfco Rollers

JACOBSEN ROTARY DECK ROLLERS

Product	DIA.	Type	Front / Rear	OEM Number	Mowers	Price
GCJ0404G5C	5"	Urethane Smooth	Front		AR-522, AR-722	\$295
GCJ2926R3C	3"	Urethane Smooth	Back	4163121, 4124015	AR-522, AR-722, AR-5	\$533
GCJ3004D3CT	3"	Urethane Smooth	Back		AR-5	\$643
GCJ3404R3CT	3"	Urethane Smooth	Back		AR-3	\$643
GCJ3429R3S	3"	Steel Smooth	Back	4163083, 4129612, 4163181	AR-3	\$533
GCJ3429R3C	3"	Urethane Smooth	Back	4163083, 4129612, 4163181	AR-3	\$533
GCR2722X4C	3"	Urethane Smooth	Back	4115430, 2206195	AR-250, AR-2500	\$694
GCR2722X4S	3"	Steel Smooth	Back	4115430, 2206195	AR-250, AR-2500	\$694

JACOBSEN GREENS & TEE MOWERS

Product	DIA.	Type	Front / Rear	OEM Number	Mowers	Price
GCJ2522A2CG	2"	GROOVED URETHANE	Front	22" GK, GM, E-PLEX, G-PLEX & ECLIPSE 122 & 322	68527	\$382
GCJ2522A2C	2"	SMOOTH URETHANE	Front	22" GK, GM, E-PLEX, G-PLEX & ECLIPSE 122 & 322	68641	\$382
GCJ2522A25CG	2.5"	GROOVED URETHANE	Front	22" GK, GM, E-PLEX, G-PLEX & ECLIPSE 122 & 322	22.25" BODY & 25.87" SHAFT	\$456
GCJ2522A25C	2.5"	SMOOTH URETHANE	Front	22" GK, GM, E-PLEX, G-PLEX & ECLIPSE 122 & 322	22.25" BODY & 25.87" SHAFT	\$396
GCJ2422S2S	2"	SMOOTH STEEL	Back	22" GK, GM, E-PLEX, G-PLEX & ECLIPSE 122 & 322	104990	\$322
GCJ2422S2C	2"	SMOOTH URETHANE	Back	22" GK, GM, E-PLEX, G-PLEX & ECLIPSE 122 & 322	3/8"-24 TAPS IN SHAFT ENDS	\$382
GCJ2422G2S	2"	SMOOTH STEEL	Back	22" GK, GM, E-PLEX, G-PLEX & ECLIPSE 122 & 322	7/16"-20 TAPS IN SHAFT ENDS	\$322
GCJ2119A2C	2"	SMOOTH URETHANE	Back	22" GK, GM, E-PLEX, G-PLEX & ECLIPSE 122 & 322	7/16"-20 TAPS IN SHAFT ENDS	\$382
GCJ2119A2CG	2"	GROOVED URETHANE	Front/ Back	ALL 18" GREENSMOWERS ECLIPSE 118, GK 418 & GK 518	68616, 63318	\$382
GCJ2119A2C	2"	SMOOTH URETHANE	Front/ Back	ALL 18" GREENSMOWERS ECLIPSE 118, GK 418 & GK 518	68626, 4108920, 417522	\$382
GCJ2119A2C	2"	SMOOTH STEEL	Front/ Back	ALL 18" GREENSMOWERS ECLIPSE 118, GK 418 & GK 518	68626, 4108920, 417522	\$322
GCJ2119S2CG	2"	GROOVED URETHANE	Front/ Back	18" ECLIPSE2 118F		\$382
GCJ2119S2C	2"	SMOOTH URETHANE	Front/ Back	18" ECLIPSE2 118F	4175221 BODY + 4175220 SHAFT	\$382
GCJ2119S2S	2"	SMOOTH STEEL	Front/ Back	18" ECLIPSE2 118F	4175221 BODY + 4175220 SHAFT	\$322

JACOBSEN TRI-KING TRIM MOWERS

Product	DIA.	Type	Front / Rear	OEM Number	Mowers	Price
GCJ3229A25CG	2.5"	GROOVED URETHANE	Front/ Back	30" TRIKING 1684D & 1900D		\$456
GCJ3229A25C	2.5"	SMOOTH URETHANE	Front/ Back	30" TRIKING 1684D & 1900D		\$396
GCJ3229A25S	2.5"	SMOOTH STEEL	Front/ Back	30" TRIKING 1684D & 1900D	132640	\$376
GCJ3229A3CG	3"	GROOVED URETHANE	Front/ Back	30" TRIKING 1684D & 1900D	132640	\$513
GCJ2119A3C	3"	SMOOTH URETHANE	Front/ Back	30" TRIKING 1684D & 1900D	67729 [SET OF 3]	\$483
GCJ2119A3S	3"	SMOOTH STEEL	Front/ Back	30" TRIKING 1684D & 1900D		

JACOBSEN FAIRWAY MOWERS

Product	DIA.	Type	Front / Rear	OEM Number	Mowers	Price
GCJ2522A3CG	3"	GROOVED URETHANE	FRONT	ALL MODELS EXCEPT 26" 2500, 3050 & 3810	123268	\$513
GCJ2522A3C	3"	SMOOTH URETHANE	BACK	ALL MODELS EXCEPT 26" 2500, 3050 & 3810		\$483
GCJ2422S2CG	2"	SMOOTH URETHANE	BACK	ALL MODELS EXCEPT 26" 2500, 3050 & 3810	22.25" BODY & 3/8"-24 TAPS IN SHAFT ENDS	\$382
GCJ2422S2S	2"	SMOOTH STEEL	BACK	ALL MODELS EXCEPT 26" 2500, 3050 & 3810	1000770	\$322
GCJ2421S25C	2.5"	SMOOTH URETHANE	BACK	ALL MODELS EXCEPT 26" 2500, 3050 & 3810	5003687, 1003728, 1002446, 100105	\$396

JACOBSEN FAIRWAY MOWERS Continued...

Product	DIA.	Type	Front/Rear	OEM Number	Mowers	Price
GCJ2421S25S	2.5"	SMOOTH STEEL	BACK	ALL MODELS EXCEPT 26" 2500, 3050 & 3810	5003687, 1003728, 1002446, 100105	\$376
GCJ2422G2C	2"	SMOOTH URETHANE	BACK	ALL MODELS EXCEPT 26" 2500, 3050 & 3810	22.25" BODY & 7/16"-20 TAPS IN SHAFT ENDS	\$382
GCJ2422G2S	2"	SMOOTH STEEL	BACK	ALL MODELS EXCEPT 26" 2500, 3050 & 3810	1000770	\$322
GCJ2422G2L	2"	SMOOTH STEEL	BACK	ALL MODELS EXCEPT 26" 2500, 3050 & 3810	1004990 LIGHT TUBING	\$322
GCJ2419S2C	2"	SMOOTH URETHANE	BACK	ALL MODELS EXCEPT 26" 2500, 3050 & 3810	19.25" BODY & 3/8"-24 TAPS IN SHAFT ENDS	\$382
GCJ2419S2S	2"	SMOOTH STEEL	FRONT/ BACK	ALL MODELS EXCEPT 26" 2500, 3050 & 3810	19.25" BODY & 3/8"-24 TAPS IN SHAFT ENDS	\$322
GCJ3026X3CG	3"	GROOVED URETHANE	FRONT/ BACK	LF 2500 & LF 3050	1/2" DIA. SHAFT ENDS	\$513
GCJ3026X3C	3"	SMOOTH URETHANE	BACK	LF 2500 & LF 3050	1/2" DIA. SHAFT ENDS	\$493
GCJ2016G2C	2"	SMOOTH URETHANE	BACK	18" LIGHT FAIRWAY SLF1880	68674, 4115860	\$382
GCJ2019S2C	2"	SMOOTH URETHANE	BACK	18" LIGHT FAIRWAY SLF1880	4135083	\$382
GCJ2019S25C	2.5"	SMOOTH URETHANE	Front/ Back	18" LIGHT FAIRWAY SLF1880	4135083	\$396

JOHN DEERE FAIRWAY MOWERS

Product	DIA.	Type	Front/Rear	OEM Number	Mowers	Price
GCD2218A25CG	2.5"	GROOVED URETHANE	FRONT/ BACK	18" 8000A PRECISION CUT & E-CUT FAIRWAY	18.0" BODY, 22" SHAFT	\$496
GCD2218A25C	2.5"	SMOOTH URETHANE	FRONT/ BACK	18" 8000A PRECISION CUT & E-CUT FAIRWAY	18.0" BODY, 22" SHAFT	\$396
GCD2218A25S	2.5"	SMOOTH STEEL	FRONT/ BACK	18" 8000A PRECISION CUT & E-CUT FAIRWAY	18.0" BODY, 22" SHAFT	\$376
GCCD2522C2CG	2"	GROOVED URETHANE	FRONT/ BACK	22" 3215 & 3225 LIGHT FAIRWAY MOWERS	22.5" BODY, 25.5" SHAFT	\$382
GCD2522C2C	2"	SMOOTH URETHANE	FRONT/ BACK	22" 3215 & 3225 LIGHT FAIRWAY MOWERS	AMT2876	\$382
GCD2522C2S	2"	SMOOTH STEEL	FRONT/ BACK	22" 3215 & 3225 LIGHT FAIRWAY MOWERS	AMT2876	\$322
GCD2522C3CG	3"	GROOVED URETHANE	FRONT/ BACK	22" 3235 LIGHT FAIRWAY MOWER	1 FLAT ON ONE END OF SHAFT	\$513
GCD2522C3C	3"	SMOOTH URETHANE	FRONT/ BACK	22" 3235 LIGHT FAIRWAY MOWER	1 FLAT ON ONE END OF SHAFT	\$483
GCD2522C3S	3"	SMOOTH STEEL	FRONT/ BACK	22" 3235 LIGHT FAIRWAY MOWER	1 FLAT ON ONE END OF SHAFT	\$443
GCD2522F3CG	3"	GROOVED URETHANE	FRONT/ BACK	22" 3235 LIGHT FAIRWAY MOWER	2 FLATS ON ONE END OF SHAFT	\$513
GCD2522F3C	3"	SMOOTH URETHANE	FRONT/ BACK	22" 3235 LIGHT FAIRWAY MOWER	2 FLATS ON ONE END OF SHAFT AMT2967	\$513
GCD2522F3S	3"	SMOOTH STEEL	FRONT/ BACK	22" 3235 LIGHT FAIRWAY MOWER	2 FLATS ON ONE END OF SHAFT AMT2967	\$443

JOHN DEERE GREEN & TEE MOWERS

Product	DIA.	Type	Front/Rear	OEM Number	Mowers	Price
GCD2119A2CG	2"	GROOVED URETHANE	FRONT	18" 180B & 180C WALKING GREENSMOWERS		\$382
GCD2119A2C	2"	SMOOTH URETHANE	FRONT	18" 180B & 180C WALKING GREENSMOWERS		\$382
GCD2522C2CG	2"	GROOVED URETHANE	FRONT/ BACK	22" 220 WALKING & 2243 RIDING GREENSMOWERS	22.5" BODY, 25.5" SHAFT	\$382
GCD2522C2C	2"	SMOOTH URETHANE	FRONT/ BACK	22" 220 WALKING & 2243 RIDING GREENSMOWERS	22.5" BODY, 25.5" SHAFT	\$382
GCD2522C2G	2"	GROOVED URETHANE	FRONT/ BACK	22" 2500 GREENSMOWER	22.5" BODY, 25.5" SHAFT	\$382
GCD2522C2C	2.5"	SMOOTH URETHANE	FRONT/ BACK	22" 2500 GREENSMOWER	AMT2876	\$382
GCD2926A25CG	2.5"	GROOVED URETHANE	FRONT/ BACK	260SL WALKING GREENSMOWER		\$456

JOHN DEERE FAIRWAY & REEL ROUGH MOWERS

Product	DIA.	Type	Front/Rear	OEM Number	Mowers	Price
GCD2522F3CG	3"	GROOVED URETHANE	FRONT/BACK	22" 7500/8500 & 7700/8700 PRECISION CUT & E-CUT	AMT2966, BM25317, BM17668	\$513
GCD2522F3C	3"	SMOOTH URETHANE	FRONT/BACK	22" 7500/8500 & 7700/8700 PRECISION CUT & E-CUT	22.45" BODY, 25.5" SHAFT- 2 FLATS ON SHAFT	\$483
GCD2522F3S	3"	SMOOTH STEEL	FRONT/BACK	22" 7500/8500 & 7700/8700 PRECISION CUT & E-CUT	22.45" BODY, 25.5" SHAFT- 2 FLATS ON SHAFT	\$443
GCD2522F2CG	2"	GROOVED URETHANE	FRONT/BACK	22" 7500/8500 & 7700/8700 PRECISION CUT & E-CUT	22.45" BODY, 25.5" SHAFT- 2 FLATS ON SHAFT	\$382
GCD2522F2C	2"	SMOOTH URETHANE	FRONT/BACK	22" 7500/8500 & 7700/8700 PRECISION CUT & E-CUT	22.5" BODY, 25.5" SHAFT- 2 FLATS ON SHAFT	\$382
GCD2522F2S	2"	SMOOTH STEEL	FRONT/BACK	22" 7500/8500 & 7700/8700 PRECISION CUT & E-CUT	22.5" BODY, 25.5" SHAFT- 2 FLATS ON SHAFT	\$322
GCD2522C3CG	3"	GROOVED URETHANE	FRONT/BACK	22" 7500/8500 & 7700/8700 PRECISION CUT & E-CUT	22.5" BODY, 25.5" SHAFT- 2 FLATS ON SHAFT	\$513
GCD2522C3C	3"	SMOOTH URETHANE	FRONT/BACK	22" 7500/8500 & 7700/8700 PRECISION CUT & E-CUT	22.25" BODY, 25.5" SHAFT- 1 FLAT ON SHAFT	\$483
GCD2522C3S	3"	SMOOTH STEEL	FRONT/BACK	22" 7500/8500 & 7700/8700 PRECISION CUT & E-CUT	22.25" BODY, 25.5" SHAFT- 1 FLAT ON SHAFT	\$443
GCD2522C2CG	2"	GROOVED URETHANE	FRONT/BACK	22" 7500/8500 & 7700/8700 PRECISION CUT & E-CUT	22.25" BODY, 25.5" SHAFT- 1 FLAT ON SHAFT	\$382
GCD2522C2C	2"	SMOOTH URETHANE	FRONT/BACK	22" 7500/8500 & 7700/8700 PRECISION CUT & E-CUT	22.25" BODY, 25.5" SHAFT- 1 FLAT ON SHAFT	\$382
GCD2522C2L	2"	SMOOTH STEEL	FRONT/BACK	22" 7500/8500 & 7700/8700 PRECISION CUT & E-CUT	22.25" BODY, 25.5" SHAFT- 1 FLAT ON SHAFT	\$382
GCD3229X3CG	3"	GROOVED URETHANE	FRONT/BACK	30" FAIRWAY [305, 303, 756 & 856]	32.25" SHAFT WITH .5" DIAMETER ENDS	\$523
GCD3229X3C	3"	SMOOTH URETHANE	FRONT/BACK	30" FAIRWAY [305, 303, 756 & 856]	32.25" SHAFT WITH .5" DIAMETER ENDS	\$493
GCD3229X3S	3"	SMOOTH STEEL	FRONT/BACK	30" FAIRWAY [305, 303, 756 & 856]	32.25" SHAFT WITH .5" DIAMETER ENDS	\$453



Golfco Rollers

JOHN DEERE ROTARY DECK ROLLERS

Product	DIA.	Type	Front / Rear		OEM Number	Mowers	Price
GCD2926C3CGR	3"	GROOVED URETHANE	BACK			9009 7400A [2016-]	\$543
GCD2926C3CR	3"	SMOOTH URETHANE	BACK		TCA17790	9009 7400A [2016-]	\$533
GCD2926C3SR	3"	SMOOTH STEEL	BACK			9009 7400A [2016-]	\$533
GCD0404G5C	5"	SMOOTH URETHANE	FRONT		TCA19047, 19H3185, U44915	7400 [PRE 2016]	\$315
GCD2926A3CR	3"	SMOOTH URETHANE	BACK		TCA17790 [3"] TCA25970	7400 [PRE 2016]	\$533
GCD2926A3SR	3"	SMOOTH STEEL	BACK		TCA17790 [3"] TCA25970	7400 [PRE 2016]	\$533
GCD2522C3C	3"	SMOOTH URETHANE	BACK			2653 - 22"	\$513
GCD3229N3C	3"	SMOOTH URETHANE	BACK			2653 - 30"	\$483

TORO ROTARY DECK ROLLERS

Product	DIA.	Type	Front / Rear		OEM Number	Mowers	Price
GC2T0505G5C	5"	SMOOTH URETHANE	FRONT		104-1092, 115-3412, 115-3418	4500D, 4700D, 3500D & 3505D	\$315
GC2T3329A3CGR	3"	GROOVED URETHANE	BACK			4500D, 4700D, 3500D & 3505D	\$543
GC2T3329A3CGR	3"	SMOOTH URETHANE	BACK		112-5265	4500D, 4700D, 3500D & 3505D	\$533
GC2T3329A3SR	3"	SMOOTH STEEL	BACK		112-5265	4500D, 4700D, 3500D & 3505D	\$533
GC2T0705G5C	5"	SMOOTH URETHANE	FRONT		115-3418, 114-0430	4300D	\$335
GC2T2824K3CGR	3"	GROOVED URETHANE	BACK			4300D	\$543
GC2T2824K3CGR	3"	SMOOTH URETHANE	BACK		108-7387	4300D	\$533
GC2T2824K3SR	3"	SMOOTH STEEL	BACK		108-7387	4300D	\$533

TORO SIDEWINDER ROLLERS

Product	DIA.	Type	Front / Rear		OEM Number	Mowers	Price
GCT3026D25CG	2.5"	GROOVED URETHANE	FRONT/BACK		92-7410, 104-1385	27" 3100D, 27" 2300D & 216	\$456
GCT3026D25CG	2.5"	SMOOTH URETHANE	FRONT/BACK		61-0410	27" 3100D, 27" 2300D & 216	\$396
GCT3227D25CG	3"	SMOOTH URETHANE	FRONT/BACK		114-9383	27" 3100D, 27" 2300D & 216	\$456
GCT3227D25C	3"	GROOVED URETHANE	FRONT/BACK		112-8915	27" 3100D, 27" 2300D & 216	\$396

TORO GREEN & TEE MOWERS

Product	DIA.	Type	Front / Rear		OEM Number	Mowers	Price
GCT2522S2C	2"	SMOOTH URETHANE	FRONT		22" MOWERS- SERIES 1000, 3, 300, 3000, 3050, 3100, 3150	52-3170	\$382
GCT2522S2S	2"	SMOOTH STEEL	FRONT		22" MOWERS- SERIES 1000, 3, 300, 3000, 3050, 3100, 3150	52-3200	\$322
GCT2522S2GCG	2.5"	GROOVED URETHANE	FRONT		22" MOWERS- SERIES 1000, 3, 300, 3000, 3050, 3100, 3150	22.5" BODY & 25.75" SHAFT	\$382
GCT2522S25C	2.5"	SMOOTH URETHANE	FRONT		22" MOWERS- SERIES 1000, 3, 300, 3000, 3050, 3100, 3150	22.45" BODY & 25.75" SHAFT	\$382
GCT2522A2C	2"	SMOOTH URETHANE	BACK		22" MOWERS- SERIES 1000, 3, 300, 3000, 3050, 3100, 3150	52-3120	\$382
GCT2522A2S	2"	SMOOTH STEEL	BACK		22" MOWERS- SERIES 1000, 3, 300, 3000, 3050, 3100, 3150	52-3120	\$322
GCT2522A25C	2.5"	SMOOTH URETHANE	BACK		22" MOWERS- SERIES 1000, 3, 300, 3000, 3050, 3100, 3150	22.45" BODY & 25.87" SHAFT	\$456
GCT2522A2C	2"	SMOOTH URETHANE	FRONT/BACK		22" TRIFLEX- 3200, 3250, 3300, 3320, 3400, 3420	52-3120	\$382
GCT2522A2S	2"	SMOOTH STEEL	FRONT/BACK		22" TRIFLEX- 3200, 3250, 3300, 3320, 3400, 3420	52-3120	\$322
GCT2522A25CG	2.5"	GROOVED URETHANE	FRONT/BACK		22" TRIFLEX- 3200, 3250, 3300, 3320, 3400, 3420	22.25" BODY & 25.87" SHAFT	\$456
GCT2522A25C	2.5"	SMOOTH URETHANE	FRONT/BACK		22" TRIFLEX- 3200, 3250, 3300, 3320, 3400, 3420	115-7388	\$396
GCT2522A25S	2.5"	SMOOTH STEEL	FRONT/BACK		22" TRIFLEX- 3200, 3250, 3300, 3320, 3400, 3420	115-7388	\$376
GCT2522A2C	2"	SMOOTH URETHANE	FRONT/BACK		FLEX 21 & FLEX 2120	52-3120	\$382
GCT2522A2S	2"	SMOOTH STEEL	FRONT/BACK		FLEX 21 & FLEX 2120	52-3120	\$322
GCT2219S2C	2"	SMOOTH URETHANE	FRONT/BACK		GM800 18"		\$382
GCT3127A25CG	2.5"	GROOVED URETHANE	FRONT/BACK		GM1600 26"		\$456
GCT3127A25CG	2.5"	SMOOTH URETHANE	FRONT/BACK		GM1600 26"		\$396
GCT3127A25S	2.5"	SMOOTH STEEL	FRONT/BACK		GN1600 26"		\$376

TORO FAIRWAY & ROUGH REEL MOWERS

Product	DIA.	Type	Front / Rear		OEM Number	Mowers	Price
GCT2722A3CG	3"	GROOVED URETHANE	FRONT		5200D, 5210D, 5400D, 5410D, 5510D & 5610D	100-9906	\$513
GCT2722A3C	3"	SMOOTH URETHANE	FRONT		5200D, 5210D, 5400D, 5410D, 5510D & 5610D	99-5749	\$483
GCT2724A3CG	3"	GROOVED URETHANE	FRONT		5200D, 5210D, 5400D, 5410D, 5510D & 5610D	114-5400	\$513
GCT2724A3C	3"	SMOOTH URETHANE	FRONT		5200D, 5210D, 5400D, 5410D, 5510D & 5610D	99-5749	\$483
GCT2522C3C	3"	SMOOTH URETHANE	BACK		5200D, 5210D, 5400D, 5410D, 5510D & 5610D	22.45" BODY & 25.5" SHAFT	\$513
GCT2522C3S	3"	SMOOTH STEEL	BACK		5200D, 5210D, 5400D, 5410D, 5510D & 5610D	22.45" BODY & 25.5" SHAFT	\$443
GCT2522C25C	2.5"	SMOOTH URETHANE	BACK		5200D, 5210D, 5400D, 5410D, 5510D & 5610D	114-5406	\$396
GCT2522C25S	2.5"	SMOOTH STEEL	BACK		5200D, 5210D, 5400D, 5410D, 5510D & 5610D	114-5406	\$376
GCT2321T2C	2"	SMOOTH URETHANE	BACK		5200D, 5210D, 5400D, 5410D, 5510D & 5610D	21.25" BODY & 23.75" SHAFT	\$382
GCT2321T2S	2"	SMOOTH STEEL	BACK		5200D, 5210D, 5400D, 5410D, 5510D & 5610D	21.25" BODY & 23.75" SHAFT	\$322
GCT2319A2C	2"	SMOOTH URETHANE	BACK		5200D, 5210D, 5400D, 5410D, 5510D & 5610D	94-0694	\$382
GCT2319A2S	2"	SMOOTH STEEL	BACK		5200D, 5210D, 5400D, 5410D, 5510D & 5610D	94-0694	\$322
GCT2722A3CG	3"	GROOVED URETHANE	FRONT/BACK		5500D, 6500D & 6700D	100-9906 22.25" BODY & 27" SHAFT	\$513
GCT2722A3C	3"	SMOOTH URETHANE	FRONT/BACK		5500D, 6500D & 6700D	99-5749 22.25" BODY & 27" SHAFT	\$483
GCT2724A3S	3"	SMOOTH STEEL	FRONT/BACK		5500D, 6500D & 6700D	99-5749 22.25" BODY & 27" SHAFT	\$443
GCT2724A3CG	3"	GROOVED URETHANE	FRONT/BACK		5500D, 6500D & 6700D	114-5400 24.25" BODY & 27" SHAFT	\$513
GCT2724A3C	3"	SMOOTH URETHANE	FRONT/BACK		5500D, 6500D & 6700D	99-5749 24.25" BODY & 27" SHAFT	\$483
GCT2724A3S	3"	SMOOTH STEEL	FRONT/BACK		5500D, 6500D & 6700D	99-5749 24.25" BODY & 27" SHAFT	\$443
GCT2522A25CG	2.5"	GROOVED URETHANE	FRONT		S100D, 5300D & 223D	75-1520	\$456
GCT2319A2C	2"	SMOOTH URETHANE	BACK		S100D, 5300D & 223D	94-0694	\$382
GCT2319A2S	2"	SMOOTH STEEL	BACK		S100D, 5300D & 223D	94-0694	\$322
GCT3429K3C	3"	SMOOTH URETHANE	BACK		4500D, 4300D, 4000D, 3500D, 450D, 335D & 350D	59-5630	\$483



MAINTENANCE

PRICE MATCH GUARANTEE with Any Major Competitor

Turf Pride



Product #	Description	Price
JF-TP-108025	80 GRIT 25# PAIL	\$93
JF-TP-110025	100 GRIT 25# PAIL	\$93
JF-TP-112025	120 GRIT 25# PAIL	\$93
JF-TP-118025	180 GRIT 25# PAIL	\$93
JF-TP-122025	220 GRIT 25# PAIL	\$93
JF-TP-150025	50 GRIT 25# PAIL	\$93

Reel Diamond Lapping Compound

- Turf Pride combines the perfect match of diamond powder and silicon along with near pure water that will stay in place to produce quicker lapping process. With a blade cutting surface that extends less bruising to the grass, leaving a high-quality cut and healthier turf. Trigger flow control.
- Environmentally safe abrasive compound
- Electronic-grade water is pH neutral and washes off with water * [see note below]
- Formulated with precisely enough viscosity to permanently suspend the abrasive
- Tackiness additives to keep the product on the blades, not on the floor or the technician
- Lubricant to dissipate heat on the blades, minimizing warp
- Rust inhibitors to minimize corrosion
- The industrial diamond compound will always provide a faster cutting action and produce a much sharper cutting edge

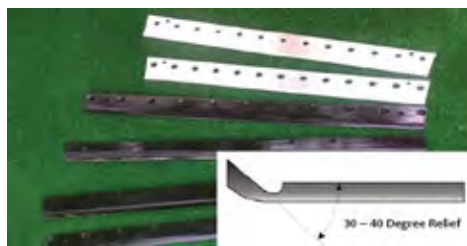

Turf Pride Bed Knives

Turf Pride Bed Knives are available in three thicknesses and are available to fit major brand greens mowers including Toro, Jacobsen, John Deere, and Husqvarna.

Hardness: Rockwell C scale 48 - 49.

Material: Spring type steel high carbon content with chrome/nickel alloys and a polished finish.

With the Turf Pride premium knives, the over all thickness from one end to the other is guaranteed not to vary more than .001". Turf Pride Premium bed knives will ensure a true golf ball roll on all putting surfaces.

Turf Pride bed knives are guaranteed to be perfectly straight without the need of grinding after attaching. We are now making a 30 - 40 degree "Manufactured Relief" standard on all of our bedknives. No need to spend time grinding relief, saving dollars.

Effective Cutting Heights:

- Turf Pride [thin bed knife] 0.100
- Turf Pride [super thin bed knife] 0.075
- Turf Pride [tournament bed knife] 0.050

Turf Pride Bed Knives

Product #	Description	Price
JF-TP-01849700	NATIONAL HYDRO 70 LOW CUT.12	\$84.95
JF-TP-01863800	NATIONAL 25" 8 HOLE BLANK	\$84.95
JF-TP-2105082	TORO GM .050 CUT	\$84.95
JF-TP-2107582	TORO GM .075 CUT	\$84.95
JF-TP-2110082	TORO GM .100 CUT	\$84.95
JF-TP-02147500	LOCKE HIGH-CUT 1/2 x 30"	\$90.00
JF-TP-2207582	JACOBSEN GM .075 CUT	\$84.95
JF-TP-2210082	JACOBSEN GM .100 CUT	\$84.95
JF-TP-2305082	JOHN DEERE .050" CUT	\$84.95
JF-TP-2307582	JOHN DEERE .075" CUT	\$84.95
JF-TP-2310082	JOHN DEERE .100" CUT	\$84.95
JF-TP-02544500	TRM 30" TURF PRIDE 7 HOLE FAIRWAY [50022134]. RR#R600215.	\$84.95
JF-TP-02818300	LOCKE CL-125	\$84.95
JF-TP-02818400	LOCKE CL-130	\$84.95
JF-TP-02818500	LOCKE 36"	\$60.00
JF-TP-02818600	LOCKE LH CL-136	\$153.80
JF-TP-02818700	LOCKE RH CL-136	\$153.80
JF-TP-79510000	JOHN DEERE ULTRA SUPER THIN.14	\$84.95
JF-TP-79520900	JACOBSEN 22" GK 13 HOLE ULTRA SUPER THIN	\$84.95
JF-TP-79521000	JACOBSEN 19" SUPER THIN ULTRA	\$84.95
JF-TP-79521200	JACOBSEN TOURNAMENT ULTRA	\$84.95
JF-TP-79522000	TORO 21" GM 13 HOLE ULTRA SUPER THIN.12	\$47.95
JF-TP-79522400	TORO TOURNAMENT ULTRA	\$84.95
JF-TP-161-004D	HUSQVARNA 22" 7 HOLE .1875.12	\$84.95
JF-TP-890-065D	SWARDMAN 55 CM ULTRA.12	\$84.95
JF-TP-1003350	TORO 21" GM 7 HOLE .194	\$84.95
JF-TP-1041380	TORO 27" RM 10 HOLE .230.11	\$84.95
JF-TP-1041810	TORO 22" RM 8 HOLE .230	\$84.95
JF-TP-1042646	TORO 26" GM 16 HOLE .194.11	\$84.95
JF-TP-1042646-U	TORO 1600 THIN	\$84.95
JF-TP-1056785	TORO 27" RM 10 HOLE .194.11	\$84.95
JF-TP-1078181	TORO 26" GM 16 HOLE .230.11	\$84.95
JF-TP-1084302U-EXT	TORO 21" GM 13 HOLE ULTRA THIN EXTENDED LIP.11	\$84.95
JF-TP-1084303U-EXT	TORO 21" GM 13 HOLE ULTRA TOURNAMENT EXTENDED LIP.11	\$84.95
JF-TP-1089096	TORO 22" RM 8 HOLE .194.12	\$84.95
JF-TP-1102300U-EXT	TORO 18" GM 11 HOLE ULTRA TOURNAMENT EXTENDED LIP.12	\$84.95
JF-TP-1102301U	TORO 18" GM 11 HOLE ULTRA THIN.12	\$84.95
JF-TP-1104074	TORO 22" RM 8 HOLE .230.12	\$84.95
JF-TP-1104084	TORO 22" RM 8 HOLE .131.12	\$84.95
JF-TP-1104084U	TORO 22" RM 8 HOLE ULTRA THIN.12	\$84.95
JF-TP-1137	LOCKE 30-3/8" STATIONARY CUTTER.12	\$44.95
JF-TP-114-0	ROSEMAN FAIRWAY	\$146.50
JF-TP-1149388	TORO 27" RM 10 HOLE .131.13	\$84.95
JF-TP-1149389	TORO 32" RM 12 HOLE .194.13	\$84.95
JF-TP-1149391	TORO 32" RM 12 HOLE .230.13	\$84.95
JF-TP-115-1880	TORO TOURNAMENT ULTRA	\$84.95
JF-TP-127-7132	TORO FAIRWAY LOWCUT 8 HOLE	\$84.95
JF-TP-14402	JOHN DEERE ULTRA THIN	\$84.95
JF-TP-14402-U	JOHN DEERE THIN ULTRA	\$84.95
JF-TP-14402-U-DE	JOHN DEERE THIN ULTRA DUAL EDGE.11	\$69.95
JF-TP-150450	SPARTAN FAIRWAY	\$84.95
JF-TP-1793	JOHN DEERE 30"	\$84.95
JF-TP-1973	JOHN DEERE 30" 12 HOLE	\$84.95
JF-TP-2810984-U	JACOBSEN TOURNAMENT 19.3125" LONG, 11 HOLE	\$84.95
JF-TP-315834	JACOBSEN DOUBLE-LIP FAIRWAY	\$54.20
JF-TP-325163	JACOBSEN 30" FWY 7 HOLE	\$84.95
JF-TP-4118902	JACOBSEN 18" GK/LWF 18.25" LONG 11 HOLE .194	\$84.95
JF-TP-4128286-U	JACOBSEN GM SUPER TOURNAMENT.12	\$84.95
JF-TP-476680	TORO 31" RM 11 HOLE .230 [SPARTAN].13	\$84.95
JF-TP-497660	TORO 31" RM 11 HOLE .230 [REEL MASTER].13	\$84.95
JF-TP-5000098U	JACOBSEN 18-1/4" GK 11 HOLE ULTRA THIN	\$84.95
JF-TP-5000098U-EXT	JACOBSEN 18" GK 11 HOLE ULTRA THIN EXTENDED LIP	\$84.95
JF-TP-5000141	JACOBSEN 26" GK/LF 11 HOLE .230	\$84.95
JF-TP-5000413	JACOBSEN 26" GK/LF 11 HOLE .131	\$84.95
JF-TP-5000414	JACOBSEN 26" GK/LF 11 HOLE .194	\$84.95
JF-TP-5002888U	JACOBSEN 18" GK 11 HOLE ULTRA TOURNAMENT.14	\$84.95
JF-TP-5002888U-EXT	JACOBSEN 18" GK 11 HOLE ULTRA TOURNAMENT EXTENDED LIP	\$84.95
JF-TP-5003150	JACOBSEN 22" GK/LF 13 HOLE .194.12	\$84.95
JF-TP-502304-U	JACOBSEN 19" TOURNAMENT	\$84.95
JF-TP-503257	JACOBSEN	\$84.95

Product #	Description	Price
JF-TP-503363	JACOBSEN TRI-KING 30".11	\$84.95
JF-TP-503460	JACOBSEN 22" GK/LF 13 HOLE .230.11	\$84.95
JF-TP-503460-EXT	JACOBSEN 22" 3/32" L. 2.50" W 13 HOLE FRONT EDGE EXTENDED 1/8".11	\$84.95
JF-TP-503475U	JACOBSEN 19" GK 11 HOLE ULTRA THIN	\$84.95
JF-TP-503475U-EXT	JACOBSEN 19" GK 11 HOLE ULTRA THIN EXTENDED LIP	\$84.95
JF-TP-503476U	JACOBSEN 19" GK 11 HOLE ULTRA TOURNAMENT.11	\$84.95
JF-TP-503476U-EXT	JACOBSEN 19" GK 11 HOLE ULTRA TOURNAMENT EXTENDED LIP.11	\$84.95
JF-TP-503477	JACOBSEN 22" GK/LF 13 HOLE .131.11	\$84.95
JF-TP-503478	JACOBSEN 22" 13 HOLE LOW PROFILE.11	\$84.95
JF-TP-503478U	JACOBSEN 22" GK 13 HOLE ULTRA THIN.11	\$84.95
JF-TP-503478U-EXT	JACOBSEN 22" GK 13 HOLE ULTRA THIN EXTENDED LIP.11	\$84.95
JF-TP-503479-PB	JACOBSEN 22" GK 13 HOLE ULTRA TOURNAMENT, PEBBLE BEACH GRIND	\$84.95
JF-TP-503479U	JACOBSEN 22" GK 13 HOLE ULTRA TOURNAMENT.11	\$84.95
JF-TP-503479U-EXT	JACOBSEN 22" GK 13 HOLE ULTRA TOURNAMENT EXTENDED LIP	\$84.95
JF-TP-503654	JACOBSEN 26" LF 11 HOLE .230	\$84.95
JF-TP-554284	JACOBSEN TRI-KING 1671D, 1684D, 1900D 26"	\$84.95
JF-TP-595890	TORO 30" RM 10 HOLE .194.13	\$84.95
JF-TP-601091	BROUWER	\$84.95
JF-TP-625180	TORO 27" 10 HOLE	\$84.95
JF-TP-638600	TORO 21" GM 13 HOLE .230.14	\$84.95
JF-TP-638610	TORO 21" GM 7 HOLE .230.12	\$84.95
JF-TP-700407	NATIONAL 21-1/4" LONG	\$84.95
JF-TP-720480	TORO 30" RM 10 HOLE .230.14	\$84.95
JF-TP-877	LOCKE 25-3/8" STATIONARY CUTTER	\$84.95
JF-TP-888990U	TORO 21" GM 6 HOLE ULTRA THIN.14	\$84.95
JF-TP-934262-PB	TORO 21" GM 13 HOLE ULTRA PEBBLE BEACH GRIND.14	\$84.95
JF-TP-934262U	TORO 21" GM 13 HOLE ULTRA TOURNAMENT.14	\$84.95
JF-TP-934263U	TORO 21" GM 13 HOLE ULTRA THIN.15	\$84.95
JF-TP-934263U-DE	TORO 21" GM 13 HOLE ULTRA THIN DUAL EDGE.15	\$83.95
JF-TP-934264	TORO 21" GM 13 HOLE .131.15	\$84.95
JF-TP-934264U	TORO 21" GM ULTRA SUPER THIN.15	\$84.95
JF-TP-939015	TORO 26" GM 16 HOLE .131.HARD STRIP TORO 1600.15.	\$84.95
JF-TP-939015U	TORO 26" GM 16 HOLE ULTRA THIN.15	\$84.95
JF-TP-945079	TORO REELMASTER, LOWCUT 32"	\$84.95
JF-TP-946392	TORO 21.25 13 HOLE 82°CS.11	\$84.95
JF-TP-946394U	TORO 21" GM 7 HOLE ULTRA TOURNAMENT.11	\$84.95
JF-TP-946395U	TORO 21" GM 7 HOLE ULTRA THIN.11	\$84.95
JF-TP-946396	TORO 21" GM 7 HOLE .194.11	\$84.95
JF-TP-948936	TORO 5500 / 6500	\$84.95
JF-TP-953147U	TORO 21" GM 6 HOLE ULTRA TOURNAMENT.11	\$84.95
JF-TP-983994	TORO 6500/5500	\$84.95
JF-TP-987260U	TORO 18" GM 11 HOLE ULTRA TOURNAMENT.11	\$84.95
JF-TP-E3559	JOHN DEERE 5800	\$84.95
JF-TP-ET17532	JD 22" QA5 13 HOLE .194.11	\$84.95
JF-TP-ET17533	JD 22" QA5 13 HOLE .131.11	\$84.95
JF-TP-ET17533U	JD 22" QA5 13 HOLE ULTRA THIN.11	\$84.95
JF-TP-ET17533U-EXT	JD 22" QA5 13 HOLE ULTRA THIN EXTENDED LIP.11	\$84.95
JF-TP-ET17534U	JD 22" QA5 13 HOLE ULTRA TOURNAMENT.11	\$84.95
JF-TP-ET17534U-EXT	JOHN DEERE 22" QA5 13 HOLE ULTRA TOURNAMENT EXTENDED LIP.12	\$84.95
JF-TP-ET17751	JD 22" QA7 9 HOLE .194.12	\$84.95
JF-TP-ET17751-AA	JD 22" QA7 9 HOLE AA MATERIAL	\$141.25
JF-TP-ET17752	JD 26" QA7 10 HOLE .194.12	\$84.95
JF-TP-ET17767	JD 22" QA5 13 HOLE .230.12	\$84.95
JF-TP-MT1973	JOHN DEERE 30" QA7 12 HOLE .194.12	\$84.95
JF-TP-MT4846U	JOHN DEERE 18" QA5 11 HOLE ULTRA TOURNAMENT.13	\$84.95
JF-TP-MT4846U-EXT	JOHN DEERE 18" QA5 11 HOLE ULTRA TOURNAMENT EXTENDED LIP.13	\$84.95
JF-TP-MT4906PB	JOHN DEERE 18" 11 HOLE PEBBLE BEACH.13	\$84.95
JF-TP-MT6947	JOHN DEERE 26" 260 15 HOLE .131.13	\$84.95
JF-TP-MT7350U	JOHN DEERE 18" THIN QA5 .11 HOLE ULTRA THIN.14	\$84.95
JF-TP-MT7350U-EXT	JOHN DEERE 18" QA5 11 HOLE ULTRA THIN EXTENDED LIP.14	\$84.95
JF-TP-MT7351PB	JOHN DEERE 22" QA5 13 HOLE .PEBBLE BEACH ULTRA.14	\$84.95
JF-TP-MT7351PB-EXT	JOHN DEERE 22" QA5 13 HOLE EXTENDED LIP 1/8" .PEBBLE BEACH GRIND - ULTRA.14	\$84.95
JF-TP-TCU25299	JD 18" QA5 11 HOLE .194.12	\$84.95
JF-TP-TCU31422	JD 18" QA5 11 HOLE .230.13	\$84.95
JF-TP-TCU32581	JD 22" QA7 9 HOLE .230.13.	\$84.95



Turf Pride

Turf Pride Reels

Turf Pride Reels are manufactured using the highest quality and purest of raw steel, Sheffield Steel, from world renowned steel mills in Sheffield England, known for providing cutlery for Royalty!! Turf Pride utilizes a one of a kind forging, tempering and forming process that produces a superior blade, resulting in outstanding performance for the professional turf manager, providing durability, extended wear and life. Turf Pride reels unique cutting edge and blade profiles keeps reels sharper with less labor. All Turf Pride reels have a relief angle and have been precision spun ground to insure perfection.

- Turf Pride reels match up exceptionally well with any make bed knife.
- Turf Pride reels come with the lifetime guarantee covering defects in materials and workmanship.



Product #	Description	Price
JF-502672	REEL - JACOBSSEN 8 BLADE 8"	\$374.50
JF-602006	REEL - TORO FLEX 2100 GM 11 BLADE	\$339.40
JF-610003	REEL - ETEROS 8 BLADE	\$330
JF-654007	REEL - JOHN DEERE 10 BLADE 3215A/3235A..AMT2894	\$362.95
JF-1357007	REEL BEARING HOUSING MAIN PLATE..D6	\$16.40
JF-1357008	REEL BEARING HOUSING ADJUSTER TAB..D6..	\$4.45
JF-1357012	REEL BEARING HOUSING TRM..D7	\$190.40
JF-01741000	REEL - NATIONAL MOWER 21" 6 BLADE 7" DIA 200296 EE360-6	\$316.80
JF-01753400	REEL - NATIONAL MOWER 8400 6 BLADE..200572 79515900 50023696	\$306.90
JF-01762600	REEL - NATIONAL MOWER 8400 8 BLADE..200839 79516000 50023701	\$336.65
JF-01763300	REEL - NATIONAL MOWER 68 WING 5 BLADE..200922 E360	\$316.80
JF-01852400	REEL - NATIONAL MOWER HYDRO 70 6 BLADE 25" WA..302491	\$351.40
JF-02230400	REEL - LOCKE CL-136 8 BLADE 36"	\$403.20
JF-02230600	REEL - LOCKE CL-136 6 BLADE ..500120	\$483.40
JF-2500540	REEL - JACOBSSEN 6 BLADE 8" ..502671	\$302.95
JF-2500542	REEL - JACOBSSEN 10 BLADE 8"	\$357.90
JF-02829800	REEL - JOHN DEERE 11 BLADE 220 WB [AMT2886 OR AMT537]	\$316.90
JF-03382900	REEL - GRAVELY 8 BLADE RH HELIX 3084..03789451	\$259.20
JF-03789400	REEL WELD - 7 BLADE R HELIX PR-3084	\$259.20
JF-03789500	REEL GRAVELY 7 BLD LH HELIX 3084	\$259.20

Product #	Description	Price
JF-79512800	REEL - JACOBSSEN GK/LF 9 BLADE RH 3/4 THREAD ..5001100, 503376 F5	\$272.55
JF-79512900	REEL - JACOBSSEN GK/LF 9 BLADE LH 3/4 THREAD ..5001099, R503375	\$271.90
JF-79513000	REEL - JACOBSSEN GK/LF 7 BLADE LH 3/4 THREAD ..5003053, R50339..F5	\$281
JF-79513100	REEL - JACOBSSEN GK/LF 7 BLADE RH 3/4 THREAD ..5003054, 5001096, R503320..F5	\$281
JF-79513600	REEL - JACOBSSEN FAIRWAY GD 6 BLADE	\$380.20
JF-79513600	REEL - JACOBSSEN FAIRWAY GD 10 BLADE	\$432
JF-79514200	REEL - JAC FAIRWAY 5 BLADE [50025905]	\$300
JF-79514400	REEL - JACOBSSEN 422/522 GK 11 BLADE ..5000148, 503616, 50026610, 021-210	\$308.80
JF-79514700	REEL - JACOBSSEN GK/LF 11 BLADE RH 3/4 THREAD 506635, 5001102, 5000029, 50030138	\$280.10
JF-79514800	REEL - JACOBSSEN GK/LF 11 BLADE LH 3/4 THREAD ..506636, 5000028, 500101, 5001101, 50030139	\$280.10
JF-79515000	REEL - JACOBSSEN 422/522 GK 7 BLADE..5000417, 50037627, 021-226	\$348.35
JF-79516700	REEL - JOHN DEERE 11 BLADE 2243/2500 ..AMT538..F5	\$308.10
JF-79517100	REEL - TRM 6 BLADE ..50019832..LOCKE	\$308.80
JF-79517200	REEL - TRM 7 BLADE..50019834..LOCKE	\$308.80
JF-79517300	REEL - TRM 8 BLADE [50019836]..LOCKE, BROUWER, LPT	\$356
JF-79517500	REEL - LOCKE 25" - 5 BLADE..2219	\$318.40
JF-79517600	REEL - LOCKE 30" - 5 BLADE..2220	\$329.95
JF-79517700	REEL - LOCKE 25" 7 BLADE	\$345.60
JF-79517800	REEL - LOCKE 30" 7 BLADE	\$357.15
JF-79518100	REEL - LOCKE CL-125 8 BLADE 25" ..5020-25-8	\$308.80
JF-79518200	REEL - LOCKE CL-125 25" 6 BLADE..5020-25-6	\$308.80
JF-79518300	REEL - LOCKE CL-130 8 BLADE..520-30-8	\$403.20
JF-79519300	REEL - TORO GM1000 11 BLADE ..132-7313, 93-6097, 50023705	\$316.80
JF-79519500	REEL - TORO GM3 8 BLADE..F5	\$308.80
JF-79519600	REEL - TORO GM3 11 BLADE	\$316.80
JF-79520100	REEL - TORO REELMASTER GD 11 BLADE	\$403.20
JF-79520200	REEL - TORO REELMASTER GD 7 BLADE..50023783 11-6879	\$403.20
JF-79523800	REEL - JACOBSSEN 518 GK 11 BLADE ..5000095	\$306.55
JF-79524500	REEL - JOHN DEERE 7 BLADE 2243/2500 ..AET11237, AET2883	\$296.40
JF-79524800	REEL - JACOBSSEN 11 BLD 22" x 7" LF135/3800/4677	\$375
JF-79528700	REEL - TORO 5210/5410 8 BLADE.. 137-8416, 108-9071, 127-2065	\$380.40
JF-TP-101329	REEL - JACOBSSEN 7 BLADE 7" DIA 22" LONG FITS JACOBSSEN LF SERIES	\$274
JF-TP-115-8255	REEL - TORO FLEX 14 BLADE TO FIT 18" TORO FLEX 18	\$485.80
JF-TP-119-4104	REEL - TORO 21" 11 BLADE	\$317.25
JF-TP-127-2066	REEL - TORO REEL MASTER 5" DIAMETER, 22", 11 BLADE..FITS TORO REEL MASTER 5410	\$332.95
JF-TP-127-2164	REEL - TORO GM1820 11 BLADE	\$345.60
JF-TP-127-2182	REEL - TORO 1000, 1010,2000 - 11 BLADE 21" 5" DIA	\$308.80
JF-TP-130-0093	REEL HD TORO GM 3,300,3000 4 BOLT, 8 BLADE	\$308.80
JF-TP-137-8432	REEL - TORO - 8 BLADE 22 x 7..F5	\$396
JF-TP-2810472	REEL - JACOBSSEN 11 BLADE 7" DIA 22" LONG FITS JACOBSSEN LF SERIES	\$369.20
JF-TP-2810741	REEL ASSEMBLY - JACOBSSEN LF-135 9 BLD	\$384
JF-TP-4225505	REEL - JACOBSSEN GK/LF 15 BLADE LH	\$622.10
JF- TP-4269791	REEL - JACOBSSEN GK/LF 15 BLADE RH	\$622.10
JF-TP-AMT2893	REEL - JOHN DEERE 8 BLADE ..AET11159	\$340.60



**Proudly Made
in the USA**



**Plastic Products Made
with 100% Recycled Plastic**



Warranty

You are sure to be pleased with the products we manufacture, as all products include a 1 year warranty from the date of purchase.

Credit Terms

Payment of invoice is due in full on the due date. Payments are accepted by Visa, Mastercard, American Express, bank or cashier's check, cash or money order. Some orders may require a deposit. Credit applications and credit checks are required for standard credit terms.

Pricing

All prices are F.O.B. shipping point unless otherwise arranged at time of order. Prices subject to change at any time without notice.

Environment

Being conscious of the earth's resources is important to us at J.F. Manufacturing, Inc. We proudly use recycled plastic in all of our plastic products.





Proud Member of the



909-902-1012

www.JFMGOLF.com / sales@jfm-golf.com

2071 S. Lynx Place
Ontario, CA 91761

Proud Supporter

